

10.2014 EvoBus GmbH

Not to be reprinted, reproduced or translated in any form without prior permission.

Address for orders:

EvoBus GmbH
Service Documentation
D-89231 Neu-Ulm

Printed in Germany

Order no.: A 632 584 04 19

Introduction

The user information supplied with each bus is intended for use only by persons who are qualified to operate the bus. The user information is split into the following parts:

- The Driver's Operating Instructions are intended to answer all important questions concerning operation of the bus in a concise and clearly understandable manner.
- More detailed and complete information, as well as further information relevant to safety, can be found in the Operating Instructions.
- The Maintenance Record serves as a guide to the technical care of the bus. It contains all the information on maintenance intervals and maintenance tasks as well as pages for confirming that the maintenance work has been carried out.

Please consult the “Safety” section before starting up the bus for the first time, and familiarise yourself with the contents of these Operating Instructions before setting off.

Items of optional equipment are also described, if their operation needs explanation. The bus delivered to you has been customised in accordance with your order, therefore some descriptions and diagrams may differ from the equipment on your bus.

The Driver's Operating Instructions, the Operating Instructions and the Maintenance Record are important documents and must always be carried in the bus.

Our buses are the subject of ongoing development. You are therefore asked to appreciate that we reserve the right to make modifications to the design, equipment and technical features. For these reasons, no claims can be made based upon the contents of this user information.

Environmental protection

The declared policy of EvoBus GmbH is one of integrated environmental protection. This policy starts at the root causes and encompasses in its management decisions all the consequences for the environment which could arise from production processes or the products themselves.

The objectives are for the natural resources which form the basis of our existence on this planet to be used sparingly and in a manner which takes the requirements of both nature and humanity into account.

Operate your vehicle in an environmentally responsible manner and you will help to protect the environment. Fuel consumption and wear in the drive train (engine, clutch, transmission, axles, brakes, tyres) are extremely dependent on your driving style.

We hope you enjoy driving your bus.

EvoBus GmbH

Mercedes-Benz Omnibusse

Vehicle identification	1	Additional maintenance tasks dependent on bus use	16	AdBlue® service product	37
Safety	3	General bus care and maintenance	16	Filling with AdBlue®	39
General safety information	4	Care and cleaning	17	Diesel particulate filter	40
Storage space for hand luggage	9	Operation	19	Diesel particulate filter regeneration	42
Driver's rest area safety precautions	9	Running-in guideline	23	Starting regeneration of the diesel particulate filter manually	44
Windscreen wiper system safety precautions	9	Starting the engine	23	Operating/malfunction displays: fuel system/exhaust gas cleaning system	46
Safety precautions for the air-conditioning system	10	Driving	25	Function description: accident data recorder (ADR) (option)	47
Operation of auxiliary heating	10	Stopping the engine	26	Brake system safety precautions	49
General	13	Towing and tow-starting	27	Emergency braking	49
Preparation for the journey - daily tasks	14	Trailer towing	30	Braking and stopping	49
Preparation for the journey - weekly tasks	15	Loading a trailer	31	Brakes with anti-locking protection	50
Preparation for the journey - monthly tasks	16	Driving with a trailer	31	Applying the parking brake	51
		Ball hitch trailer coupling (fixed) (option)	32	Releasing the parking brake	52
		Ball hitch trailer coupling and open-jaw trailer coupling (detachable) (option)	32	Emergency braking in the event of failure of both brake circuits	52
		Connecting the power supply	33	EBS brake system (system description)	53
		Trailer coupling maintenance	33	Acceleration skid control (ASR)	54
		Refuelling (diesel fuel)	34	Brake Assist	54
		BlueTec® exhaust gas cleaning system	35		

Table of contents

Electronic Stability Program (ESP)	55	Care/cleaning of fabric covers	78	Location of the first-aid kits	107
Operating/malfunction displays: brake system	56	Care/cleaning of micro-fibre covers	80	Tow bar location (option)	108
Activating the slip increase function of ASR (acceleration skid control)	58	Care/cleaning of leather covers	81	Location of spare mirror (option)	108
Operating/malfunction displays: ABS/ASR	59	At a glance	85	Emergency hammer (option)	108
Electronic Stability Program (ESP) (function description)	62	Driver's area overview	88	Driver's rest area	110
Deactivating the Electronic Stability Program (ESP)	64	Switches on the left section of the instrument panel	89	On-board kitchenette refrigerator control panel	112
Operating/malfunction displays: brake system	65	Switches on the right section of the instrument panel	94	Tour guide refrigerator control panel	114
Operating 230/400 V systems (option)	70	Instrument cluster	96	Windscreen washer reservoir	116
Fitting the skibox (option)	71	Tachograph (installation position)	98	Seat belt reminder display	117
Swivelling the skibox (option)	73	DTCO tachograph	100	Exterior flaps on the Turismo 15 RHD (example of 2-axle bus)	118
Additional operating instructions for the skibox (option)	74	Tachograph	102	Design and function description: fire detection system	119
Note on maintenance work	74	Destination display safety precautions	102	Operating and malfunction displays: fire detection system	119
Care and cleaning	75	Destination display control panel	104		
Care/cleaning of light-alloy wheels	76	Door pushbutton in the driver's area	106	Driver's area controls	121
Care and cleaning of covers, upholstery and ceiling	77	Scope of tools and emergency equipment	107	Rotary light switch	123
		Location of the fire extinguishers	107	Steering column switch for light and wiper functions	124
				Steering column switch for retarder and cruise control (overview)	124
				Adjustable steering column	129

Ignition switch	129	Important information on the steering system	147	Pushbutton for GO 240-8 transmission shift system failsafe mode (option) (activation of failsafe mode and R)	155
Parking brake and emergency release device	130	Turning the steering wheel when the bus is stationary	147	Creep mode pushbutton	155
Basic settings menu on display screen	131	Activating the attendant call system	148	Display control pushbutton	156
Brightness setting of the display screen and instrument lighting	132			Driver's area lighting switch	156
Display screen in the instrument cluster	133	Switch descriptions	149	ADR pushbutton	157
Calling up and interpreting the fuel consumption indicator (option)	140	Master safety switch (emergency-off switch) (national variant)	152	Reading lamps switch	157
Air suspension safety precautions	142	Mirror adjuster	153	Passenger-compartment lighting switch positions I+II	157
Raising/lowering the bus	142	Windscreen roller sunblind pushbutton (option)	153	Night lighting switch	158
Normal level	143	Pushbutton for co-driver's roller sunblind (option)	153	Roof hatch pushbutton - air in/air out (option)	158
Activating/deactivating axle load transfer for trailing axle (3-axle buses only)	144	Axle load transfer switch (3-axle buses only)	154	Attendant call system switch	159
Activating/deactivating the bus stop brake (option)	145	Diesel particulate filter (DPF) regeneration start/inhibit	154	"School bus operation" pushbutton (option)	159
Activating/deactivating the drive-off lock (option)	146	Electronic Stability Program (ESP) OFF pushbutton	154	Audible reverse warning feature switch (option)	159
		Pushbutton for GO 240-8 transmission shift system failsafe mode (option) (2/4 and N)	155	Driver's power window pushbutton	160
				Pushbutton for raising/lowering the bus	160
				Normal-level pushbutton	160
				Passenger stop request system enabling switch	161

Table of contents

Switch for the driver's window heating/mirror heating	161	Hazard warning lamps switch	166	Fitting a seat squab	179
Windscreen heating switch (option)	162	Door I pushbutton	167	Seat belt reminder display	180
Horn changeover switch (option)	162	Door II pushbutton	167	Passenger seat service set	182
Central locking pushbutton for the left-side luggage compartment	162	Bus stop brake emergency release switch (option)	167		
Central locking pushbutton for the right-side luggage compartment	163	ADR button (accident data recorder) (option)	168		
Kitchenette enabling switch (option)	163				
Lavatory enabling switch (option)	163	Driver's seat/passenger seats	169	Transmission shift systems	185
Switch for electrical circuits > 100 V (option)	164	Driver's seat	170	Transmission shift system safety precautions	186
Seat microphone switch	164	Grammer driver's seat control elements	172	Operating the PSH (pneumatic shift aid) transmission shift system	187
Pushbutton for hanging up the intercom (option)	164	ISRI 6860/875 driver's seat controls (option)	174	Transmission shift system GO 250-8 (system description)	187
Selection pushbutton for intercom in the driver's rest area/kitchenette (option)	165	Operation of the jump seat	176	GO 250 - 8 gearshift unit (selector lever) (option)	190
Switch for deactivating pedal-activated continuous braking	165	Adjusting a passenger seat	177	Operation of the GO 250-8 PowerShift transmission shift system (option)	191
Bus stop brake pushbutton (option)	166	Using the driver's seat belt	178	Operation of the GO 250-8 PowerShift failsafe mode (option)	203
		Operating the jump-seat seat belt	178		
		Passenger-compartment-seating seat belt	179		
		Removing a seat squab	179		
				Driving systems	207
				Driving systems	208
				Automatic speed limiter	209
				Automatic speed limiter (function description)	209

Variable speed limiter (Tempo- set)	210	Activating the reheat function	228	Unlocking the door circuit at the front right door	245
Activating the variable speed limiter (Tempo- set)	211	Activating the auxiliary heating unit	229	Unlocking door 2	246
Combined drive/brake cruise control (option)	213	Programming auxiliary heating switch-on times	231	Unlocking the door circuit using the radio remote control (option)	246
Activating combined drive/brake cruise control (option)	214	Activating a programmed auxiliary heating switch-on time	233	Unlocking the luggage compartment flaps using the pushbuttons in the driver's area	247
<hr style="border: 2px solid red;"/>					
Heating/ventilation/air-condi- tioning	217	Deactivating an activated switch-on time	234	Unlocking the luggage compartment flaps using the remote control (option)	248
Operating instructions for the air- conditioning system	218	Programming the auxiliary heating switch-on duration	235	Locking door 2	248
Heating/ventilation/air-conditioning (HVAC) control panel	220	Switches/controllers in the driver's rest area	236	Locking door 1	249
Manually regulating the blower speed in the driver's area	223	<hr style="border: 2px solid gray;"/>			
Preselecting the passenger- compartment temperature	224	Opening/locking	239	Locking using the radio remote control (option)	250
Manually regulating the blower speed in the passenger compart- ment	226	Door pushbutton in the driver's area	241	Central locking system (option) (system description)	251
Activating the air-conditioning	227	Anti-entrapment protection (revers- ing) as the doors are closed	242	Operating/malfunction displays: central locking	254
Activating air-recirculation mode in the driver's area/passenger compartment	228	Protection against entrapment in the door opening direction	242	Emergency operation of the doors (depressurising the doors using the emergency valves)	255
		Locking the exterior emergency valve at door 2 (option)	243	Emergency unlocking of the luggage compartment flaps in the event of a compressed-air supply failure	257
		Operating/malfunction displays: doors	243		

Table of contents

Opening/closing the service cover under the driver's window	258	Switching on the sausage heater	279	Draining the 2-carafe filter system	296
Opening/closing the roof hatches manually	259	Cleaning the sausage heater	282	Draining the siphon	297
Emergency exit through emergency operation of the electric roof hatches (option)	260	Descaling the sausage heater	282	Replacing fuses	298
<hr/>					
On-board kitchenette	263	Switching on the 40-cup coffee machine	283	Malfunctions	300
General information	266	Brewing coffee in winter	287	Restoring boiler operation following a malfunction	300
Instructions for operating a microwave oven	267	Cleaning the 40-cup coffee machine	287	Using the sausage heater again after a malfunction	301
Use for the intended purpose	269	Switching on the 2-carafe filter system	288	Using the 40-cup coffee machine again after a malfunction	302
Approved personnel	269	Brewing 1/2 a carafe of coffee (10 cups of coffee)	289	Using the 2-carafe filter system again after a malfunction	303
First use of the galley	270	Brewing 1 carafe of coffee (20 cups of coffee)	289	Other malfunctions	304
Switching on the galley	271	Brewing 2 carafes of coffee (40 cups of coffee)	290	Switching off the galley	305
Filling the fresh water tank inside the bus	272	Manual operation of the 2-carafe filter system	291	<hr/>	
Filling the fresh water tank outside the bus	274	Descaling the coffee machine	292	On-board kitchenette (Eltesan)	307
Checking and cleaning the fresh water filter	274	Winter operation	293	General information	308
Drawing water from the water tap	275	Draining the fresh water tank	293	Use for the intended purpose	309
Switching on the boiler	276	Draining the water lines	294	Approved personnel	309
Descaling the boiler	277	Draining the boiler	295	Switching on the on-board kitchenette (Eltesan)	309
		Draining the 40-cup coffee machine	296	Draining the water from the tap (Eltesan)	311

Filling with fresh water (Eltesan)	312	Switching on the coffee machine	329	Using the boiler (option) again after a malfunction	344
Troubleshooting (Eltesan)	314	Brewing 1/2 a carafe of coffee (10 cups of coffee)	329	Other malfunctions	345
Winter operation (Eltesan)	315	Brewing 1 carafe of coffee (20 cups of coffee)	330	Switching off the galley	346
On-board kitchenette (integrated in the lavatory cabin) 317		Descaling the coffee machine	331	Lavatory 349	
Safety precautions/general information	319	Dispensing cups of hot water (alternative to coffee machine)	332	Enabling the lavatory	350
Use for the intended purpose	320	Boiler (option)	333	Switchover between water (WC) and chemical (CC) operation (option)	352
Approved personnel	320	Setting the thermostat of the water heater	334	Flushing the WC	353
First use of the kitchenette	320	Descaling the water heater boiler	335	Drawing water at the handwash basin	354
Switching on the kitchenette	321	Winter operation	336	Filling the soap dispenser	354
Filling the fresh water tank inside the bus	323	Draining the fresh water tank	337	Adding paper hand towels	355
Filling the fresh water tank outside the bus	324	Draining the water lines	337	Adding toilet paper	355
Checking and cleaning the fresh water filter	324	Draining the boiler	338	Opening the basin undercabinet	355
Drawing water from the water tap	325	Draining the siphon	339	Changing waste bags	356
Switching on the sausage heater	325	Replacing fuses	339	Filling the fresh water storage tank	356
Cleaning the sausage heater	328	Malfunctions	342	Emptying the fresh water storage tank	357
Descaling the sausage heater	328	Using the sausage heater again after a malfunction	342	Emptying the solid waste container	358
		Using the coffee machine again after a malfunction	343		

Table of contents

Winter operation	359	Tyre tread	391	Pneumatic system test ports under the driver's area	412
Checking the residual current device for the 230 V socket (option)	360	Tyre condition	392	Pneumatic test ports behind door 2	414
Greasing the impeller of the CC pump	361	Tyre age	392	Other pneumatic test ports	416
Practical advice	363	Invisible tyre damage	392	Charging the compressed-air system of another bus (option)	417
Overview of the operating, function and malfunction display screen	368	Tyre load capacity, top speed of tyres and types of tyres	393	Operating the bus stop brake/ drive-off lock emergency release switch (option)	419
Engine oil level display	376	Retreaded tyres	393	Operating/malfunction displays: steering system	420
Oil level alerts	377	Tyre pressures table 295/80 R 22.5	394	Bleeding the fuel system using the electric fuel pump (option)	420
Oil level information	379	On-screen tyre pressure monitor	395	Replacing the water heater fuel filter	421
Checking the engine oil level with the dipstick (option)	382	Safety measures to be taken in the event of a flat tyre or a wheel change	396	Electrical system safety precautions	421
Safety precautions for work carried out in the engine compartment	383	Fitting snow chains	397	General safety precautions for batteries	422
Removing the drive belts (OM 470)	384	Removing the spare wheel from the spare wheel cover	398	Safety precautions for handling batteries	422
Fitting the drive belts (OM 470)	386	Positioning the jack	399	Measures required for the prevention of damage to buses or components during electric welding work	423
Checking the coolant level of the engine and heating system	389	Removing the wheel nut cover or wheel trim (option)	400		
Tyres - operating safety and roadworthiness	390	Removing the wheels	401		
Tyre pressure	391	Fitting the spare wheel	406		
		Fitting the wheel nut cover or wheel trim (option)	408		
		Inflating tyres using the tyre inflator connection (option)	409		

Electrical system (illustration shows 15 RHD as an example)	426	Fuse assignment for the power distribution board (PDB), Turismo RHD	456	Emergency operation of the doors (depressurising the doors using the emergency valves)	478
Battery isolating switch (with switch-off authorisation LED)	428	Fuse assignment for the ceiling switch panel, Turismo RHD	460	Emergency unlocking of the luggage compartment flaps in the event of a compressed-air supply failure	479
Driver's area interior switch panel	430	Fuse assignment for roof-mounted heating, ventilation and air-conditioning system (Webasto)	462	Removing the exterior mirror, fitting the emergency mirror (option)	481
Main switch panel (under the driver's area)	432	Fuse assignment for roof-mounted heating, ventilation and air-conditioning system (Konvekta)	464	Emergency operation for heating in driver's area	482
Auxiliary switch panel	434	Handling fuses	465	Emergency operation of the passenger-compartment heating	483
PDB fuse switch panel	436	Disconnecting vehicle batteries	466	Maintenance tasks for the air-conditioning system in the bus (filter maintenance)	484
Ceiling switch panel	438	Recharging vehicle batteries	468	Scopes of maintenance for the air-conditioning system	486
Electrical connection for the roof-mounted system (heating, ventilation, air-conditioning)	440	Notes on jump-starting	468	Cleaning the heating system water filter	489
Battery compartment	442	Jump-start procedure	469	Bleeding the coolant circuit for the heating system	491
Notes on fuse assignments	443	Activation of on-board diagnostics	470		
Fuse assignment for the driver's area interior switch panel, Turismo RHD	444	Interpreting the on-board diagnostics screen display	471		
Fuse assignment for the main switch panel (under the driver's area), Turismo RHD	446	Clearing the fault memory of the selected system	472		
Fuse assignment for the auxiliary switch panel, Turismo RHD	448	Ending on-board diagnostics	472		
Fuse assignment for auxiliary switch panel with PDB	452	Changing bulbs	472		
		Adjusting the headlamps for driving on the left or right (only in buses with bi-xenon headlamps)	477		
				Technical data	495
				Vehicle data	496
				Overview of bulbs	497

Table of contents

Index	499
--------------------	------------

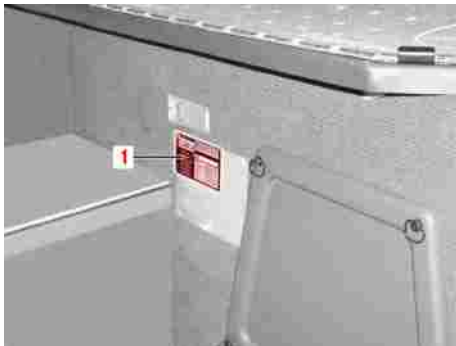

M00_00-0316-01

The vehicle identification plate bearing the vehicle identification number (VIN) and information regarding permissible weights is located in the front doorway



Note:

It is very important to identify the vehicle exactly so that the correct “vehicle data” can be assigned. You will also need the VIN when ordering replacement parts and making technical enquiries.

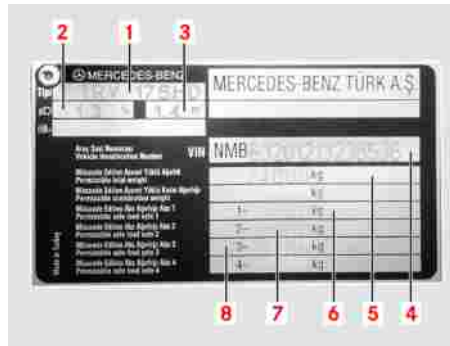

M00_00-0315-01

No.	Designation	Value
1	Vehicle designation	
2	Headlamp basic setting	
3	Headlamp basic setting	
4	Vehicle Identification Number (VIN)	NMB 632035 13
5	Permissible gross vehicle weight	

No.	Designation	Value
6	Permissible axle load for front axle	
7	Permissible axle load for driven axle	
8	Permissible axle load for trailing axle	

Decoding a vehicle identification number (VIN) using NMB 632035 13 (xxxxxx) as an example:

NMB	World-wide manufacturer code
NMB	MB Turkey
WEB	EvoBus Germany
VF9	EvoBus France
VS9	EvoBus Spain

Vehicle identification

63203x Vehicle model designation number

63203x	Tourismo RHD
--------	--------------

5 Vehicle length

5	12.96 m
---	---------

6	12.14 m
---	---------

7	13.99 m
---	---------

1 Steering

1	Left-hand-drive vehicle
---	-------------------------

2	Right-hand-drive vehicle
---	--------------------------

3 Body type

3	Complete bus
---	--------------



M00_00-0082-01

The vehicle identification number (arrowed) is also marked on the skeleton in the forward section of the bus. It can be accessed via the spare wheel cover (to open, use the lever in the entrance of the front right door).

General safety information	4
Storage space for hand luggage	9
Driver's rest area safety precautions	9
Windscreen wiper system safety precautions	9
Safety precautions for the air-conditioning system	10
Operation of auxiliary heating	10

General safety information

General safety information

The use of symbols and their meanings

Safety precautions and other important information are highlighted by symbols.

In addition to the instructions provided herein, all generally applicable safety and accident prevention regulations must also be observed, e.g. in Germany, the rules and regulations of the institutions for statutory accident insurance and prevention.

Instructions and information printed on the packaging for components, tools and service products must also be observed.

Where information and instructions are to be observed, it is assumed that the user information is intended for persons who are suitably qualified to carry out the tasks by nature of their education, training and experience.

These persons should, at the same time, be able to identify risks that may arise in the undertaking of their tasks and take the necessary measures to avoid them.

Meaning of symbols:



Note:

Notes about important additional information



Caution:

Warning notes about damage that may occur in the event of non-compliance



Danger.

Warning notes for risks to persons



Environmental protection

Notes about environmental protection measures

▷ Reference to more detailed and additional user information

Notes on vehicle safety

We recommend that you:

- Use only genuine parts that are OMNIplus quality tested and conversion parts and accessories that have been expressly approved by EvoBus for the bus model concerned in order to rule out the possibility of jeopardising road safety and invalidating the warranty and general operating permit. These parts have been specially tested for their safety, reliability and suitability.

You can obtain further information from any OMNIplus Service Partner.

Operating safety

Important information:

- Any work or modifications that have been carried out incorrectly on the bus may result in malfunctions.
- Tampering with electronic components and their software may cause malfunctions. As electronic components are networked, these malfunc-

- tions may also cause other, indirectly related systems to malfunction. These malfunctions may jeopardise the operating safety and reliability of the bus.
- Retrofitted electrical or electronic devices must possess type-approval complying with Directive 95/54/EC or ECE Directive 10/02.
 - Materials that are fitted in the bus during the course of installation, conversion or modification work and that are subject to mandatory fire-testing requirements must satisfy the requirements of EU Directive 95/28/EC.
 - Materials and components of seats and seat fixtures that are also fitted in the bus during the course of installation, conversion or modification work must satisfy the requirements of the following directives: 76/115/EEC as amended by 96/38/EC, 74/408/EEC as amended by 96/37/EC, 77/541/EEC as amended by 96/36/EC.

- At the time of purchase or installation, it must be checked that these materials and components have been certified accordingly. The use of materials or components that have not been granted the relevant certificate may result in the operating permit being invalidated.
- We recommend that you have work or modifications carried out by an OMNIplus Service Partner.

EU Directive 2001/85

Registration as class 1: city bus

- Vehicles constructed with areas for standing passengers, to allow frequent passenger movement.

Registration as class 2: interurban bus

- Principally for the carriage of seated passengers. Designed to allow the carriage of standing passengers in the gangway and/or in an area which does not exceed the space provided for two double seats.

Registration as class 3: tourist coach

- Exclusively for the carriage of seated passengers.

Important information for buses classified in accordance with EU Directive 2001/85 into class 2 and 3 (mixed approval):



Note:

The operator of the bus is responsible for ensuring that the bus is restored to the condition consistent with the permissible type of operation of the class concerned.



Note:

For instance, this means that, in the case of a bus being used in accordance with class 2, it is necessary to ensure that the bus is operated with seating having no aisle-side sideways adjustment.

General safety information

Navigation and global positioning system

If your bus is equipped with a navigation system, please observe the following instructions and information:



Danger.

Please devote your attention primarily to road and traffic conditions. Do not attempt to operate the navigation and positioning system unless the bus is stationary. Please bear in mind that your bus will cover a distance of 14 metres every second at a speed of only 50 km/h. The navigation system is unable to take into consideration the maximum load-bearing capacity of bridges or the required headroom clearance for underpasses. The driver is responsible for checking the load-bearing capacity of bridges and headroom clearances encountered en route.

Operation of radio and mobile communications equipment

(e.g. telephone, two-way radio, fax machine, etc.)



Danger.

Please devote your attention primarily to road and traffic conditions. Do not operate the display unit, radio or mobile communications equipment unless the traffic situation permits this to be done safely. Please bear in mind that your bus will cover a distance of 14 metres every second at a speed of only 50 km/h.



Danger.

Please observe local legal requirements governing the use of mobile phones or on-board telephones/intercoms in force in the country of vehicle operation.

Operation of mobile phones and two-way radios without an exterior aerial

We advise against making or receiving telephone calls in buses not equipped with an exterior aerial as the operation of radio transmitters, which include but are not limited to radio telephones (mobile phones), may cause inadequately

shielded equipment (cardiac pacemakers included) to malfunction.



Note:

If a mobile phone, radio system or fax machine is retrofitted in the bus in a manner that does not comply with EvoBus installation specifications, the operating permit for the bus could be invalidated (EU Directive 95/54/EC).



Note:

Older peripherals (e.g. ticket-printing machines, ticket-cancelling machines, destination displays, etc.) that are still used in new buses must comply with the technical requirements of EC Directive 72/245 EEC.



Danger.

Please observe local legal requirements governing the use of mobile phones or on-board telephones/intercoms in force in the country of vehicle operation.

Stickers

There are various warning stickers affixed to your bus. These are intended to make you and others aware of various dangers. Therefore, do not remove any warning stickers unless it is expressly stated on the sticker that you may do so.



Danger.

If you remove warning stickers, this could result in you or other persons failing to recognise dangers. You or others could be injured as a result.

Data stored in the vehicle

A host of electronic components in your vehicle contain a data memory. These data memories store information, temporarily or permanently, relating to

- Vehicle condition
- Events
- Faults

These items of technical information generally document the state of a component, module, system or the environment. These could be, for example:

- Operating states of system components. These include fill levels, etc.
- Status messages relating to the vehicle and its individual components. These include, for example, wheel rotation speed/driving speed, deceleration, lateral acceleration, accelerator pedal position.
- Malfunctions and defects in important system components. These include lights, brakes, etc.
- Responses and operating states of the vehicle in specific driving situations. These include, for example, triggering of an airbag, intervention of stability control systems.
- Environmental states. These include outside temperature, etc.

The data are exclusively technical in nature and can be used for

- assisting the detection and rectification of faults and defects,
- analysing vehicle functions, e.g. after an accident,
- optimising vehicle functions.

Motion profiles on driven routes cannot be generated from these data. Whenever you arrange for a particular vehicle service, these items of technical information can be read out from the event and fault data memories.

Services include, for example:

- Repairs
- Customer service processes
- Warranty claims
- Quality assurance

This read-out is performed by employees in the ServiceNetwork (including manufacturers) with the use of special diagnostic testers. They enable you to obtain further information as and when necessary. After faults have been recti-

General safety information

fied, the information in the fault memory is cleared or continuously overwritten. During use of the vehicle, certain situations could arise in which these technical data could become personal data when combined with other information - where applicable under the direction of an independent expert.

Examples include:

- Accident logs
- Damage to the vehicle
- Witness statements

Other auxiliary functions that are contractually agreed with the customer similarly permit the outgoing communication of vehicle data from the vehicle. Example:

- FleetBoard telematics system

Washing the outside of the bus in an automatic vehicle wash

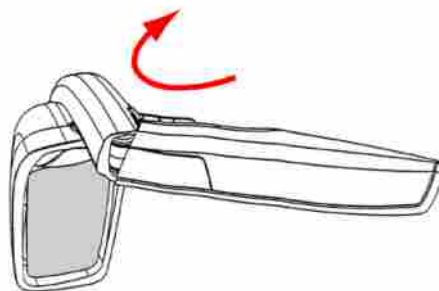

M88_00-0004-01

Before the bus is washed, make sure that the roof hatches, driver's window and the doors are closed. Set the heating/ventilation/air-conditioning system to air-recirculation mode (Smog button). Before the bus is washed, fold both integral mirrors inwards towards the windscreen by means of the hinge pin on the mirror arm.

After the washing process, fold the integral mirrors outwards again.

Remove any attachment parts that may be fitted (e.g. satellite receiver on the roof) before the bus is washed.

Storage space for hand luggage

Storage space for hand luggage



T68_00-0018-31

The storage spaces above the passenger seats are suitable for light hand luggage items only.



Danger.

Occupants may be injured if the bus is braked sharply, changes direction suddenly or is involved in an accident due to objects being thrown around the bus. Heavy or hard objects should therefore not be carried inside the bus without being secured.

Driver's rest area safety precautions

The driver's rest area must only be used by the bus driver (second driver).

The on-board telephone may only be used by the driver in accordance with legal requirements. Observe the legal requirements of the country concerned.

Windscreen wiper system safety precautions



M54.00-2004-71



Danger.

RISK OF INJURY. The battery isolating switch (01S01) must always be switched off before any work is carried out on the windscreen wiper system (wiper blade cleaning, replacement of wiper blades or wiper motor etc.).

Safety precautions for the air-conditioning system

Safety precautions for the air-conditioning system

Air-conditioning systems that are operated with refrigerant R 134 a are labelled with appropriate stickers and/or plates on the compressor.

Never mix R 134 a refrigerant and the corresponding Triton SE 55 refrigerator oil with other products.

In accordance with current good engineering practices, it is prohibited to allow refrigerant to escape into the environment when operating, servicing or decommissioning air-conditioning systems. Refrigerants and refrigerator oils must be disposed of or recycled separately by type and nature.

Only persons having the relevant and necessary specialist knowledge, technical equipment and official approval (by health and safety inspectorate, local authority, TÜV or equivalent) are permitted to carry out maintenance work on air-conditioning systems and take back refrigerants and oils.

The operator must maintain a logbook auditing the consumption of refrigerant and refrigerator oils.



In automatically controlled air-conditioning systems, the ventilation blowers of condenser or evaporator units may start up at any time. Therefore, always switch the ignition starter switch to OFF before any cleaning work is carried out. Do not reach into the fan blades or fan rollers. Avoid any contact with refrigerant as there is a risk of frostbite. Treat affected skin areas as for frostbite, and seek medical attention immediately. Carry out maintenance and repair tasks with the engine switched off whenever possible. Keep a safe distance from moving parts (e.g. belt drive) when the engine is running.

Operation of auxiliary heating



Risk of fire and burns. There is a risk of fires and burns due to the high exhaust temperatures and the hot exhaust pipe for the auxiliary heating. For this reason, do not stop or park the bus over ignitable materials (e.g. grass) when the auxiliary heating is in operation, has recently been in operation or has been operated by the immediate heating button/preset clock.



Risk of poisoning and suffocation. The auxiliary heating must not be used in enclosed spaces such as garages or workshops due to the risk of poisoning and suffocation. It must also not be used in timer or preselection mode.

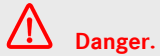

Risk of explosion. The auxiliary heating must be switched off at filling stations and fuel dispensing systems due to the risk of explosion.



Risk of fire. The auxiliary heating must remain switched off in places where ignitable vapours or dust can accumulate (e.g. in the vicinity of filling stations, fuel, coal, sawdust and grain stores or similar).

Preparation for the journey - daily tasks 14

Preparation for the journey - weekly tasks 15

Preparation for the journey - monthly tasks 16

Additional maintenance tasks dependent on bus use 16

General bus care and maintenance 16

Care and cleaning 17

Preparation for the journey - daily tasks

Preparation for the journey - daily tasks

- ▶ Check the windscreen washer fluid level and test the windscreen washer system and windscreen wipers.
- ▶ Check the fuel level for the engine and water heater

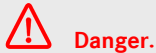

Danger.

Switch off the engine and auxiliary heating before refuelling.

- ▶ Check the AdBlue additive level in the BlueTec exhaust gas cleaning system
- ▶ Check the electrical system, paying particular attention to the headlamps, turn signals, tail lamps, brake lamps and licence plate lamps.



Note:

Under certain weather and operating conditions, moisture may form on the inside of the headlamps and other lights when the bus is stationary. This does not indicate a fault or defect. The ventilation openings in the headlamps allow this moisture to evaporate soon after the bus has pulled away.

- ▶ Check the luggage compartment flaps for secure locking
- ▶ Check the emergency exits
- ▶ Insert the driver card.



Note:

The indicator lamp in the tachograph lights up if no driver card is inserted.

- ▶ Check that the emergency equipment is accessible and complete, e.g. first-aid kit, fire extinguisher, warning triangle, emergency hammer for side windows, jack.

- ▶ Check the position of the rear-view mirrors, clean the mirrors, test the mirror heating.
- ▶ Check tyre pressures and tyre condition (including the spare wheel). Check that the wheel nuts are firmly seated.



M40_00-0115-71

- ▶ Check wheel hubs (1) on all wheels for leaks inside and out (visual check).

Preparation for the journey - weekly tasks

**Note:**

If the wheel hubs are leaking, there may be grease or oil residue on the tyres themselves or deposits on the parking area on which the bus is standing. Consult an OMNIplus Service Partner in the event of a leak.

Preparation for the journey - weekly tasks

- ▶ Check the coolant level in the cooling system and top it up if necessary. Check the corrosion inhibitor/anti-freeze concentration each time the coolant has been topped up and correct if necessary.

**Note:**

See the Specifications for Service Products

- ▶ Check the oil level in the hydraulic steering system and top it up if necessary.

**Caution:**

If the oil level is low, have the steering system checked at an authorised specialist workshop.

- ▶ Check the belt tension of all belt drives.

- ▶ Carry out a visual check to ensure there are no leaks in the engine, transmission, driven axle, steering or the cooling and heating systems.
- ▶ Drain the fuel prefilter in the engine compartment.

**Note:**

Refer to the “Practical advice” section.

- ▶ Check the acid level in the starter batteries (only on buses with lead-acid batteries).

**Danger.**

Observe the safety precautions in the “Practical advice” section.

- ▶ Check the seat belts (belt arrester). Check the belt straps for damage (visual check).

Preparation for the journey - monthly tasks

Preparation for the journey - monthly tasks

- ▶ Check the residual current device for the 230 V socket (option) in the lavatory.

Additional maintenance tasks dependent on bus use

- ▶ The bus operator must plan further maintenance tasks for the heating/ventilation/air-conditioning system (driver's area and passenger compartment) in addition to those indicated in the Maintenance Record.



Note:

Refer to the “Practical advice” section.

General bus care and maintenance

- ▶ Carry out the work specified in the Maintenance Record



Caution:

Regular maintenance of the chassis and drive train is essential to maintaining the operating safety and roadworthiness of the bus. The time intervals and the scope of work required are specified in the Maintenance Record supplied with the bus.



Caution:

It is strongly recommended that the specified maintenance intervals be observed.

**Note:**

Warranty claims based on our terms and conditions of sale and delivery may be rejected if the periodic maintenance tasks have not been carried out at the specified distances (odometer readings) or times. Have confirmation of the completed work recorded in the Maintenance Record by an OMNIplus Service Partner.

Care and cleaning

▷ You will find further instructions for and notes on cleaning and caring for your bus in the “Operation” section

**Note:**

The following stipulations for exterior cleaning must be observed: Use a sufficient amount of fresh water. Dry rubbing between washing brushes and the vehicle must not be allowed to occur. Preclean heavily soiled components. The polishing of lighting equipment with commercially available care products is not permitted. The use of polyethylene fibres as a brush material is not permitted. Recommendation: Use brushes made with textile fibres or foam.

Running-in guideline	23
Starting the engine	23
Driving	25
Stopping the engine	26
Towing and tow-starting	27
Trailer towing	30
Loading a trailer	31
Driving with a trailer	31
Ball hitch trailer coupling (fixed) (option)	32
Ball hitch trailer coupling and open-jaw trailer coupling (detachable) (option)	32
Connecting the power supply	33
Trailer coupling maintenance	33
Refuelling (diesel fuel)	34
BlueTec® exhaust gas cleaning system	35
AdBlue® service product	37
Filling with AdBlue®	39

Table of contents

Diesel particulate filter	40
Diesel particulate filter regeneration	42
Starting regeneration of the diesel particulate filter manually	44
Operating/malfunction displays: fuel system/exhaust gas cleaning system	46
Function description: accident data recorder (ADR) (option)	47
Brake system safety precautions	49
Emergency braking	49
Braking and stopping	49
Brakes with anti-locking protection	50
Applying the parking brake	51
Releasing the parking brake	52
Emergency braking in the event of failure of both brake circuits	52
EBS brake system (system description)	53
Acceleration skid control (ASR)	54
Brake Assist	54
Electronic Stability Program (ESP)	55

Operating/malfunction displays: brake system 56

Activating the slip increase function of ASR (acceleration skid control) 58

Operating/malfunction displays: ABS/ASR 59

Electronic Stability Program (ESP) (function description) 62

Deactivating the Electronic Stability Program (ESP) 64

Operating/malfunction displays: brake system 65

Operating 230/400 V systems (option) 70

Fitting the skibox (option) 71

Swivelling the skibox (option) 73

Additional operating instructions for the skibox (option) 74

Note on maintenance work 74

Care and cleaning 75

Care/cleaning of light-alloy wheels 76

Care and cleaning of covers, upholstery and ceiling 77

Table of contents

Care/cleaning of fabric covers	78
Care/cleaning of micro-fibre covers	80
Care/cleaning of leather covers	81

Running-in guideline

▶ Running in the chassis and drive train

**Note:**

The way in which the chassis and drive train of the new bus are treated during the first 3,000 miles (5,000 km) is critical to the bus' future performance and service life.

**Note:**

The load to which the bus is subjected during this period should be increased only gradually. The maintenance and lubrication tasks specified in the Maintenance Record should be carried out conscientiously.

**Caution:**

Do not place the engine under full load during the running-in period. Up to 1,200 miles (2,000 km): run in with care. Drive at no higher than 3/4 of the maximum rpm in each gear. After 1,200 miles (2,000 km): slowly increase to the

economic rpm in each gear. During the running-in period, do not drive the bus for long distances at the same road speed = same rpm. Varying engine speeds and therefore varying loads demanded of the entire drive train are favourable to the running-in of the bus.

Starting the engine

- ▶ The parking brake must be applied. Transmission in neutral.

**Note:**

Do not depress the clutch pedal while starting the engine.

**Note:**

At outside temperatures of below -20 °C, preheat the engine with the water heater (see heating/ventilation/air-conditioning control panel).

**Note:**

The bus is equipped with an immobiliser. The engine cannot be started without one of the authorised keys.

Starting the engine

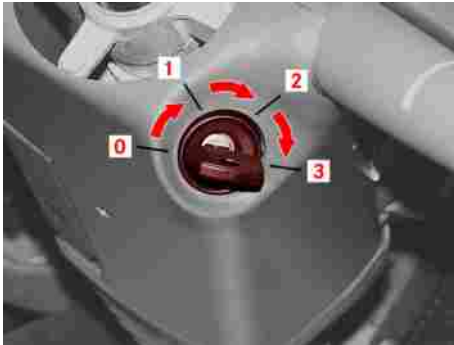

M54_00-0083-01

- ▶ Turn the ignition switch to position 2, the bus carries out an indicator lamp check (all indicator lamps must light up briefly), then turn the ignition switch to position 3 but do not depress the accelerator pedal.

If necessary, cancel the starting procedure after a maximum of 15 seconds and wait for about 1 minute before repeating the starting procedure. Turn the key fully back before making a further attempt to start the engine.



Note:

After a maximum of 3 starting attempts, wait (about 15 minutes) before trying again.



If this icon appears on the screen in conjunction with a yellow warning signal sounds, you have made 5 starting attempts using an invalid key. The immobiliser has been activated.



Note:

Use a valid key or valid spare key.



Note:

Each further starting attempt with an invalid key increases the waiting period by 1 further minute.



Note:

For emergencies, we recommend that you always carry a spare key to which you have access at all times.

- ▶ Release the key when the engine starts.



Caution:

It is not permitted to increase the engine speed while the “Oil pressure too low” symbol is shown on the display screen. If the “Oil pressure too low” symbol appears for more than 10 seconds, turn off the engine immediately and establish the cause.



- ▶ Observe the screen display: if malfunction messages appear, determine the cause and rectify it.

**Danger.**

If there is insufficient pressure in the compressed-air supply system (reservoir pressure operating displays remain on the screen), a warning signal sounds until the required pressure has been reached. Do not release the parking brake until there is sufficient operating pressure.

Driving**Environmental protection**

Never warm up the engine while the bus is stationary. Instead, drive off and run the engine at moderate speeds.

**Note:**

The engine should not be placed under full load until it has reached normal operating temperature (75 °C - 90 °C depending on operating conditions and the outside temperature).

**Danger.**

All doors must be unlocked before the bus is driven off.

**Danger.**

The freedom of movement of the pedals must not be restricted. The operating safety and roadworthiness of the bus would otherwise be at risk. Objects could fall and get caught between the pedals if you were to accelerate or brake suddenly, with the result that you would no longer be able to brake, depress the clutch pedal or accelerate. You could cause an accident and put yourself and other people in danger.

- ▶ Check the freedom of movement of the pedals

**Danger.**

Where floor mats and carpets are fitted, ensure that they are safely secured against slipping and that there is sufficient space for the pedals.

Stopping the engine



Danger.

Do not put any objects in the driver's footwell.



Danger.

Stow and secure all loose objects in such a way that they cannot get into the driver's footwell when the bus is in motion.

- ▶ Always pull away in 1st gear at 600 - 800 rpm.



Danger.

Test the function of the service brake immediately after pulling away.

- ▶ Observe the rev counter while driving.



Note:

Keep within the economical operating range. Make sure that the engine speed does not enter the danger zone (red zone).



Danger.

If a warning buzzer sounds when you are shifting gear, too low a gear has been selected. Make sure that you keep the clutch pedal depressed and select a suitable gear for the current speed.

Stopping the engine

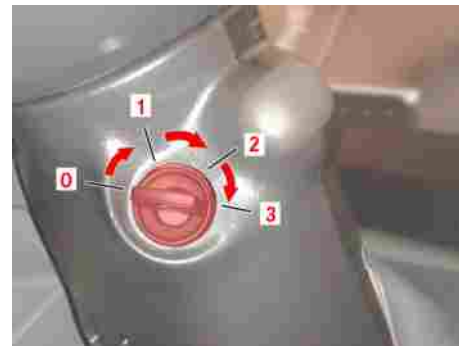

M54.00-2270-71

- ▶ Stop the bus - Shift the transmission into neutral - Apply the parking brake. Turn the ignition starter switch from position 2 (drive position) back to position 1.

**Danger.**

There is a risk of fire and burns due to the high exhaust temperatures and the hot exhaust pipe for the auxiliary heating. For this reason, avoid parking the bus where ignitable material (e.g. dry grass, leaves, etc.) is in close proximity to the exhaust system, engine and auxiliary heating exhaust system.

**Note:**

Before you switch off the engine, allow it to continue running at idling speed for approximately 1-2 minutes (to allow the exhaust turbochargers to cool down if the coolant temperature is high or if you have been driving at full engine output (e.g. on hilly roads)).

Towing and tow-starting**Danger.**

Only authorised specialists (recovery service) are permitted to tow away broken-down buses. The rules and regulations in the country concerned must be observed.

**Danger.**

The ignition switch of the vehicle being towed must always be in position 1. The steering lock must not be engaged. Failure to comply with this guideline could result in the steering locking.

**Danger.**

In buses with the Electronic Stability Program (ESP), this function must be deactivated without exception - refer to the "Operation" section

**Caution:**

Special measures are required in order to protect the transmission if the bus is to be towed: for safety reasons the propeller shaft must always be removed. The propeller shaft securing screws at the axle flange must be removed and those at the transmission flange secured against displacement.

▷ For notes on safety and operation relating to the trailer coupling, refer to the "Operation" section.

Towing and tow-starting



M00_00-0358-71

- ▶ Front/rear towing hitch:

i Note:

To tow the bus, there are some towing jaws in the vehicle tool kit that have to be screwed into locating bore (1) provided behind the front flap or in the rear member.

i Note:

For notes on charging the compressed-air system of a bus to be towed, refer to the “Practical advice” section.

- ▶ Screw the towing coupling into locating bore (1).

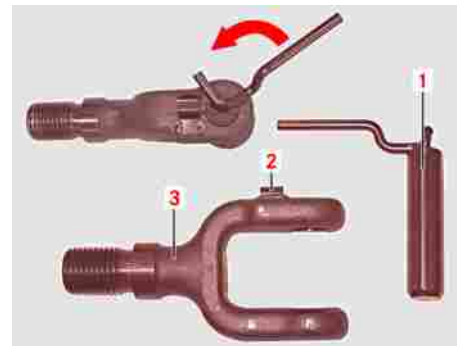

M00_00-0340-71

- ▶ Insert the rigid tow bar into towing coupling (3) and secure with the linchpin. Turn linchpin (1) towards the rear until it engages in lock (2).

i Note:

Linchpin (1) must always remain engaged in lock (2) when the bus is being towed.

- ▶ Removal of the rigid tow bar in reverse order



Note:

Pull lock (2) up slightly in order to disengage linchpin (1) towards the front.

- ▶ Towing with a raised front axle



Danger.

The ignition switch must not be switched to position 2 while the front axle is raised. The wheels on the driven axle may lock. Failure to comply could result in brake intervention by the ABS/ASR system, which could cause the rear axle to skid.

- ▶ Tow-starting (only for manual transmission)



Note:

The bus cannot be tow-started unless the batteries are fully charged (at least 21 V).



Caution:

The bus must not be tow-started unless the batteries are connected. Turn the ignition switch to the drive position. Depress the clutch pedal fully. Select 2nd or 3rd gear. Tow-start the bus, release the clutch pedal and depress the accelerator pedal until the engine is running.



Note:

Vehicles with automated manual transmission (option) cannot be tow-started.



Note:

For notes on the jump-start procedure, refer to the “Practical advice” section.



Caution:

There is a risk of damage to the left-hand exterior mirror caused by the towing vehicle as the bus is being towed through tight left-hand bends. There is a risk of damage to the bus caused by the tow bar as the bus is being towed through tight right-hand bends. Observe the information/instructions on the sticker on the tow bar.

Trailer towing

Trailer towing



Danger.

Proceed with utmost care and caution when hitching up the trailer. Make sure that no persons are present between the trailer and vehicle as the vehicle is being reversed into engagement with the trailer. The overrun brake of a trailer can rebound uncontrollably when in overrun mode. To reduce the risk of serious injuries, do not uncouple any trailer that has an overrun brake if the trailer has overrun and the overrun brake is applied. A trailer that has been coupled to the towing vehicle incorrectly could break away. A correctly coupled trailer must stand horizontal behind the vehicle. Use a trailer with a height-adjustable drawbar if necessary. The maximum permissible nose-weight and rear axle load of the bus must not be exceeded.



Note:

Observe the operating instructions issued by the trailer manufacturer.



Note:

If the trailer coupling is a detachable coupling, the operating instructions issued by the trailer coupling manufacturer must be observed.



Note:

Trailers having a maximum gross weight of higher than 3.5 t require that appropriate body reinforcement measures be implemented during vehicle manufacture. In this case, ESP (Electronic Stability Program) would no longer be available (even with no trailer coupled).



Note:

It is prohibited to couple a turntable trailer or any trailer equipped with ESP.

Loading a trailer

Observe the following values when loading the trailer:

- the permissible gross weight of the trailer
- the permissible trailer load of the vehicle and the trailer tow hitch
- the permissible noseweight
- the permissible rear axle load of the towing vehicle
- the permissible gross weight of both the towing vehicle and the trailer

The definitive maximum permissible values are listed in the vehicle documents and on the identification plates of the trailer tow hitch, trailer and vehicle. If there are discrepancies between any of these sources, always consider the lowest value to be valid.

Driving with a trailer

The following changes in handling characteristics can be observed when driving with a trailer attached:

- acceleration and gradient-climbing capability are reduced
- braking distance is increased
- sensitivity to crosswinds is increased
- directional stability is adversely affected
- fuel consumption is increased

Avoid driving a vehicle/trailer combination faster than 80 km/h, even in countries where higher speeds are permitted.

Maintain a greater distance from the vehicle in front than you would when driving without a trailer.

Avoid sudden braking where possible. Brake gently at first to allow the trailer to run on and quickly increase your braking force.

If the trailer begins to swing from side to side:

- release the accelerator pedal
- do not countersteer
- brake if necessary
- do not attempt to draw the vehicle/trailer combination out by accelerating

The gradient-climbing capabilities from a standstill refer to sea level. When driving in mountainous areas, you should bear in mind that the power output of the engine and thus its gradient-climbing capability decrease with increasing altitude.

On long and steep downhill gradients, select a lower gear/shift range in good time. This makes use of the braking effect of the engine, reducing the amount of braking effort required to maintain a safe speed. The load on the brake system is therefore reduced, which helps to prevent the brakes from overheating and wearing too rapidly. If additional braking effort is required, do not depress the

Ball hitch trailer coupling (fixed) (option)

brake pedal with one continuous press, but operate it at intervals.



Danger.

While the vehicle is in motion, never keep the brake pedal continuously depressed, e.g. by allowing the brakes to rub by resting your foot on the pedal. This would cause the brake system to overheat, increase the braking distance and may result in a complete loss of braking effect.

Ball hitch trailer coupling (fixed) (option)



Note:

Observe the operating instructions issued by the trailer manufacturer.

- ▶ Secure the trailer against rolling away.
- ▶ Reverse the vehicle until the towing ball on the trailer drawbar is positioned precisely above the ball end on the vehicle.
- ▶ Hitch the trailer as described in the operating instructions issued by the trailer manufacturer.

Ball hitch trailer coupling and open-jaw trailer coupling (detachable) (option)



Note:

Observe the operating instructions issued by the trailer manufacturer.



Note:

Observe the operating instructions issued by the trailer coupling manufacturer.

- ▶ Secure the trailer against rolling away.
- ▶ The trailer coupling is fitted to the mounting on the end cross member.
- ▶ To gain access to the mounting, remove the cover from the bumper and stow the cover inside the bus.

Connecting the power supply

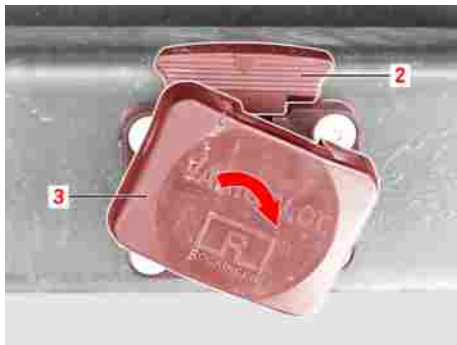

M00_00-0512-71

- ▶ Installation: slide catch (2) backwards and hold in this position. Turn cover (3) through approximately 30° and remove. Fit the trailer coupling in reverse order.

i Note:

Removal in reverse order. The trailer coupling must be removed whenever it is not in use.

Connecting the power supply

i Note:

Before connecting the cable, check that the voltage of the consumers on the trailer is the same as the voltage of the consumers on the towing vehicle.

- ▶ To gain access to the trailer socket, remove the cover from the bumper and stow the cover inside the bus.
- ▶ Insert the trailer connector into the socket on the bus.

i Note:

Route the cable in such a way that it yields to any movement without tension, kinking or friction, including movements associated with cornering.

- ▶ Check that the lights on the trailer are clean and working correctly.

Trailer coupling maintenance

- ▶ Clean the trailer coupling and lubricate it with multipurpose grease.
- ▶ Check the bolts securing the trailer coupling to the end cross member for firm seating and retighten them if necessary.

Refuelling (diesel fuel)

Refuelling (diesel fuel)

The vehicle has a two-tank system fitted to the front of the front axle. The fuel tanks are interconnected through their bases by a fuel line. The bus can be refuelled from either side. If the fuel tanks on your bus are interconnected, it is necessary to remove the fuel cap from each of the fuel tanks.

The addition of flow improvers is not permitted.

Switch off the engine and auxiliary heating before refuelling. Park the bus on a level surface.

Cleanliness is of utmost importance when refuelling. Do not leave cotton rags or cloths in the vicinity of the open filler neck.



Caution:

Refuel using only commercially available, sulphur-free diesel fuel complying with European standard EN 590 as revised from 2010 onwards (max. 0.001 % sulphur by weight). Fuels containing more than 0.001 % sulphur by weight or other

types of fuel such as marine diesel fuel, heating oils or fatty acid methyl ester FAME (biodiesel fuel) are not permitted. These types of fuel would cause irreversible damage to the engine and BlueTec®6 exhaust gas aftertreatment system and considerably reduce expected service life.



Danger.

Risk of injury and explosion. Fuel is highly flammable. Fire, naked flames and smoking are therefore prohibited when fuel is being handled.



Danger.

Before refuelling, switch off the auxiliary heating to prevent fuel vapours from igniting on the auxiliary heating exhaust system.



Danger.

Fuel is toxic and harmful to health. For this reason, make sure that the fuel does not come into contact with skin, eyes or clothing, that you do not inhale fuel vapours and that children are kept away from the fuel.



Danger.

If you or others have come into contact with fuel: In case of contact with the eyes, rinse them immediately and copiously with clean water and seek medical attention. Clean affected areas of skin immediately with soap and water. Immediately change out of clothing that has come into contact with fuel. If fuel has been swallowed, seek medical attention immediately.



Environmental protection

If handled improperly, fuels constitute a hazard to health and the environment. Fuels must not be allowed to enter the sewerage system, surface water, ground-water or soil.

BlueTec® exhaust gas cleaning system

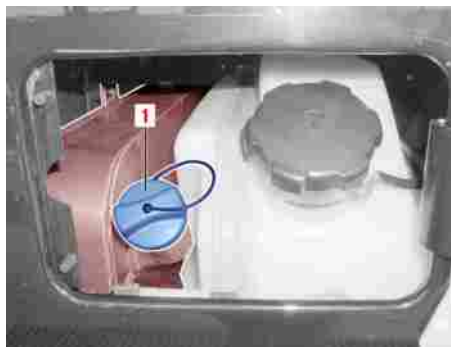

M47_00-0055-71

The BlueTec® exhaust gas cleaning system essentially comprises a supply tank, a catalytic converter and an AdBlue® metering system. It is monitored and controlled electronically. Pollutants in the exhaust gas are converted into environmentally friendly substances by the addition of AdBlue® and the catalytic converter integrated into the silencer. The illustration above shows filler opening (1) for the AdBlue® supply tank (next to the diesel tank).



Note:

AdBlue® is consumed at a rate of approximately 3 % of the rate of diesel fuel consumption. It is recommended that the AdBlue® supply tank also be refilled at every regular refuelling stop.

To function correctly, the BlueTec® exhaust gas cleaning system requires the addition of a reducing agent (AdBlue®). The addition of AdBlue® does not form part of the routine scope of bus maintenance – it is the responsibility of the vehicle operators to ensure that the AdBlue® supply tank is regularly replenished. Filling and operating the bus with AdBlue® is mandatory for compliance with emission regulations and is thus one of the conditions for the road traffic approval of the bus. The road traffic approval of the bus will be invalidated if the bus is operated without AdBlue®. It would then be against the law to operate the bus on public roads. In some countries, operation of the bus without AdBlue® may be considered to be a criminal offence or a violation of administrative

BlueTec® exhaust gas cleaning system

law punishable by fine. Support in the purchase or operation of the bus, i.e. tax relief, road tax, may also be invalidated retrospectively. This may be the case both in the country in which the vehicle is registered and in other countries in which the vehicle is operated.



Danger.

It is essential that work relevant to safety or work on safety-related systems be carried out at a qualified specialist workshop.



Danger.

Always have maintenance work carried out at a qualified specialist workshop which has the necessary knowledge and tools.



Note:

AdBlue® freezes at a temperature of approximately -11 °C. The bus is equipped with an AdBlue® preheating system as standard. Winter operation is therefore guaranteed, even at temperatures of below -11 °C.



Environmental protection

AdBlue® is biologically degradable. Unless it is handled properly, however, AdBlue® constitutes an environmental hazard. Do not allow AdBlue® to enter the sewerage system, surface water, groundwater or soil in significant volumes.



Danger. Risk of poisoning and injury.

AdBlue® is not classified as a hazardous substance by German regulations governing hazardous substances. Nevertheless, certain points should be observed when handling AdBlue®.

The AdBlue® line system and the system components connected to it are pres-

surised while the engine is warm. There is a risk of scalding from hot AdBlue® spraying out if the line system is suddenly opened. There is also the risk of skin irritation or damage to the eyes if AdBlue® comes into contact with the skin or eyes.

- Wear gloves
- Wear protective clothing
- Wear safety goggles
- Work on the exhaust gas aftertreatment system should not be commenced until approximately 4 minutes have passed as individual lines continue to be flushed even after the engine has been switched off.
- Switch the ignition starter switch to the “OFF” position and remove the key before work is carried out on the SCR system.
- Allow the AdBlue® line system to cool down
- Open line connections and system component covers/caps slowly.
- Capture any AdBlue® that escapes in a suitable container and dispose of it in an environmentally responsible manner.

- Do not pour AdBlue® into drinks containers.
- Wipe up any spilled AdBlue®, especially as there is a risk of slipping.
- AdBlue® collected in this way must not be poured back into the AdBlue® supply tank.
- Rinse affected areas of skin copiously with clean water.
- Quickly change out of clothing that has come into contact with the substance.
- In case of contact with the eyes, rinse them immediately and copiously with clean water and seek medical attention if necessary.
- If AdBlue® enters the mouth or is swallowed, rinse the mouth out with clean water and then drink plenty of water.
- Seek medical attention if symptoms persist.

AdBlue® service product

AdBlue® is a non-flammable, colourless, odourless water-soluble liquid.



Caution:

Use only AdBlue® complying with DIN 70070/ISO 22241. Special additives are not permitted.



Caution:

If, during a top-up, AdBlue® comes into contact with painted or aluminium surfaces, rinse down these surfaces with water immediately.



Note:

Avoid inhaling ammonia vapours. Fill the AdBlue® reservoir only in well-ventilated areas.



Note:

AdBlue® should not be swallowed or allowed to come into contact with skin, eyes or clothing. Keep AdBlue® out of the reach of children.



Note:

If you do come into contact with AdBlue®, observe the following: Wash AdBlue® off skin immediately with soap and water. If AdBlue® gets into the eyes, rinse them immediately and copiously with clean water. Seek medical attention without undue delay. If you have swallowed AdBlue®, immediately rinse your mouth out with water and then drink plenty of water. Seek medical attention without undue delay. Change out of clothing contaminated with AdBlue® immediately.

Properties of AdBlue® at high temperatures

AdBlue® service product



Note:

Ammonia vapours may be released as a product of the decomposition of AdBlue® if the content of the AdBlue® tank heats up to over 50 °C for a lengthy period (e.g. as a consequence of direct sunlight).



Note:

Ammonia vapours have an acrid odour. For this reason, you should avoid inhaling any ammonia vapours that may escape when you remove the AdBlue® filler cap. Ammonia vapours are an irritant mainly to skin, eyes and mucous membranes.

Properties of AdBlue® at low temperatures



Note:

AdBlue® freezes at a temperature of approximately -11 °C. The bus is equipped with an AdBlue® preheating system as standard. Winter operation is therefore guaranteed, even at temperatures of below -11 °C.

AdBlue® additives



Caution:

Do not add any additives to AdBlue®. Do not dilute AdBlue® with tap water. Doing so could destroy the exhaust gas cleaning system. Damage to the exhaust gas cleaning system caused by additives/tap water will invalidate the warranty.

Storage



Caution:

For the storage of AdBlue®, use only containers made from polypropylene, polyethylene or high-alloy CrNi steels or Mo-CrNi steels complying with DIN EN10088-1/2/3. Containers made of aluminium, copper, cupriferous alloys and non-alloyed or galvanised steels are not suitable for the storage of AdBlue®. If stored in such containers, AdBlue® could dissolve out constituents of these metals and destroy the exhaust gas cleaning system. The vehicle warranty will be invalidated if damage to the exhaust gas cleaning system is found to have been caused

by constituents dissolved out of non-approved storage containers.

Disposal of AdBlue®



Note:

Observe country-specific legislation and requirements governing the disposal of AdBlue®.

AdBlue® purity



Note:

It is prohibited to return to the tank any AdBlue® that has been pumped out, e.g. during a repair, because the purity of the liquid would no longer be guaranteed.

Filling with AdBlue®

**Note:**

An accidental filling of the AdBlue® supply tank with diesel fuel and vice versa is prevented by various technical precautionary measures.

**Note:**

It is recommended that the AdBlue® supply tank also be refilled at every regular refuelling stop.

**Caution:**

Use only AdBlue® complying with DIN 70 070. Special additives are not permitted.

**Caution:**

If, during a top-up, AdBlue® comes into contact with painted or aluminium surfaces, rinse down these surfaces with water immediately.

**Note:**

AdBlue® freezes at a temperature of approximately $-11\text{ }^{\circ}\text{C}$. The bus is equipped with an AdBlue® preheating system as standard. Winter operation is therefore guaranteed, even at temperatures of below $-11\text{ }^{\circ}\text{C}$.



M54.00-2057-71

- Read AdBlue® fill level (1)

**Note:**

To read the AdBlue® level, call up the relevant operating display using the display control pushbutton on the instrument panel.

Diesel particulate filter



M54.00-2056-71

- ▶ If the level in the AdBlue® supply tank falls to approximately 33 %, icon (1) appears on the screen to remind the driver that an AdBlue® top-up is due.
- ▶ The driver is informed by an icon on the display screen (see illustration) in conjunction with a yellow alert if the AdBlue® supply tank runs empty or if there is a malfunction in the BlueTec® exhaust gas cleaning system. In this event, it is necessary to top up the AdBlue® level immediately or remedy the fault.

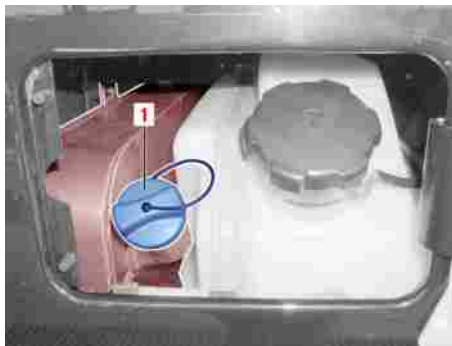

M47_00-0055-71

- ▶ Add AdBlue® to supply tank (1).

i Note:

AdBlue® supply tank (1) is located next to the diesel tank.

i Note:

An accidental filling of the AdBlue® supply tank with diesel fuel and vice versa is prevented by various technical precautionary measures.

Diesel particulate filter

Under normal circumstances, automatic regeneration of the diesel particulate filter is sufficient to avoid heavy soot loading of the filter. However, if the bus is predominantly driven short distances or with the engine under low load, it might not be possible for automatic regeneration to finish successfully.

An indicator lamp in the instrument cluster warns that the diesel particulate filter is nearing a high load state and indicates that appropriate action needs to be taken.

The on-board computer gives prompt warnings of emission-relevant malfunctions or user errors and displays their respective priority by means of yellow or red alerts.

If these messages are disregarded, there is a risk of engine power output being reduced and a need to exchange the diesel particulate filter prematurely.

**Note:**

As long as no flashing yellow or constant red malfunction alert appears, it can also be sufficient to alter the load profile (e.g. take the bus for a drive on the motorway) in order to ensure that automatic regeneration of the diesel particulate filter finishes successfully.

**Note:**

In the event of a malfunction in the BlueTec® exhaust gas aftertreatment system, have the system checked and repaired at a qualified specialist workshop.

**Danger.**

Exhaust fumes are produced during the automatic and manual regeneration processes. If you were to inhale these exhaust fumes, you could suffer harmful effects such as poisoning. For this reason, the bus should always be parked outdoors. If, however, the bus is parked in an enclosed room, adequate ventilation must be ensured.

**Danger.**

Very hot exhaust fumes are expelled from the exhaust tail pipe during the automatic and manual regeneration processes. Keep well clear of the exhaust tail pipe. Otherwise, you could be burned by the fumes.

**Danger.**

Make sure that no highly flammable materials, e.g. dry grass or fuels, come into contact with the exhaust system during the automatic and manual regeneration processes. Do not leave the bus parked

up at a filling station, on dry grass or on harvested crop fields. The hot exhaust system could otherwise cause the highly flammable material to ignite and set the bus on fire.

If the diesel particulate filter load state becomes critical, a yellow indicator lamp lights up in the instrument cluster. The on-board computer displays a yellow event window prompting you to start manual regeneration. The manual regeneration process lasts approximately 30 to no more than 60 minutes.

**Note:**

The time needed for manual regeneration is dependent on the temperature of the exhaust system.

**Note:**

If the yellow event window and its message are disregarded, there is a risk of engine power output being reduced and a need to exchange the diesel particulate filter prematurely.

Diesel particulate filter regeneration



Danger.

Exposure to diesel soot and soot particles through contact or inhalation is harmful to health and can lead to death. If you need to exchange a diesel particulate filter yourself due to technical problems, be sure to observe the information and instructions in the workshop information and all applicable occupational safety and accident-prevention regulations. Wear gloves and a dust mask. Seal and pack a particle-laden diesel particulate filter in the original packaging immediately after removal. A particle-laden diesel particulate filter must be labelled and must not under any circumstances be left uncovered indoors.

Diesel particulate filter regeneration

Functions:

- Automatic regeneration of the diesel particulate filter
- Inhibiting automatic regeneration of the diesel particulate filter
- Catalytic converter protection function

Automatic regeneration of the diesel particulate filter

Whenever the green “Particulate filter” indicator lamp  in the instrument cluster lights up, this means that the diesel particulate filter is undergoing automatic regeneration.



Note:

Automatic regeneration does not start unless all necessary operating conditions have been fulfilled, e.g. engine oil or exhaust gas temperatures sufficiently high and engine running.



Note:

In addition, automatic regeneration is not possible with the engine idling or running at an elevated idling speed. It cannot finish without a good period of actual driving because this is the only time in which the necessary temperatures are reached in the exhaust gas aftertreatment system.



Note:

If regeneration is in progress and one of the operating conditions is subsequently no longer fulfilled, the green indicator lamp  goes out prematurely and regeneration is aborted.



Note:

It restarts automatically when all necessary operating conditions are fulfilled again. If you possibly can, therefore, avoid interrupting a journey while the green “Particulate filter” indicator lamp  is lit. This will prolong the period of regeneration.

Diesel particulate filter regeneration



Note:

If the elevated exhaust gas temperatures associated with regeneration may present a danger, e.g. where the heat produced may jeopardise safety, it is possible to inhibit the automatic regeneration process.

Inhibiting automatic regeneration of the diesel particulate filter

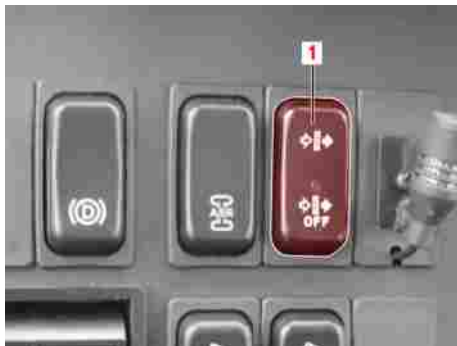

M54.00-2129-71

If the elevated exhaust gas temperatures associated with regeneration may present a danger, e.g. where the heat produced may jeopardise safety, it is possible to inhibit the regeneration pro-

cess. Neither automatic nor manual regeneration can then be initiated and regeneration is stopped if it is already in progress.

Press the lower section of pushbutton (1).



Note:

The LED in the “Inhibit regeneration” pushbutton comes on and no regeneration can be started.



Caution:

Leave the regeneration inhibitor activated only for as long as the danger exists. Whenever you activate the regeneration inhibitor, regeneration will continue to be inhibited even after the next engine start.

To deactivate, press the lower section of inhibit pushbutton (1) again.



Note:

The LED in the pushbutton goes out.

Catalytic converter protection function

In very rare cases (e.g. frequent low load operation with relatively low exhaust temperatures), there is a possibility of unburnt fuel collecting in the exhaust system. The exhaust system could suffer damage as a result.

To prevent this, the engine speed is automatically increased for approximately 20 to 30 minutes by the exhaust gas aftertreatment control module under specific circumstances. This raises the exhaust temperature and burns off the fuel.

Starting regeneration of the diesel particulate filter manually



Note:

A corresponding message appears on the display screen to indicate that the catalytic converter protection function is active.



Note:

It is possible to interrupt this function by switching off the engine, engaging a gear or releasing the parking brake.

Starting regeneration of the diesel particulate filter manually

- ▶ Pull over safely with regard for other traffic and leave the engine running. Park well clear of other vehicles, objects and all flammable materials.



Note:

Under normal circumstances, automatic regeneration of the diesel particulate filter is sufficient to avoid heavy soot loading of the filter. However, if the bus is predominantly driven short distances or with the engine under low load, it might not be possible for automatic regeneration to finish successfully.



Note:

If the diesel particulate filter load state becomes critical, an indicator lamp  lights up in the instrument cluster. The on-board computer displays a yellow event window prompting you to start manual regeneration. The manual regeneration process lasts approximately 30 to no more than 60 minutes, depending on the temperature of the exhaust system.

- ▶ Apply the parking brake.
- ▶ Shift the transmission to neutral N.
- ▶ Take your foot off the accelerator pedal.
- ▶ If active, deactivate the regeneration inhibitor.



Note:

refer to “Inhibiting automatic regeneration of the diesel particulate filter”.

Starting regeneration of the diesel particulate filter manually

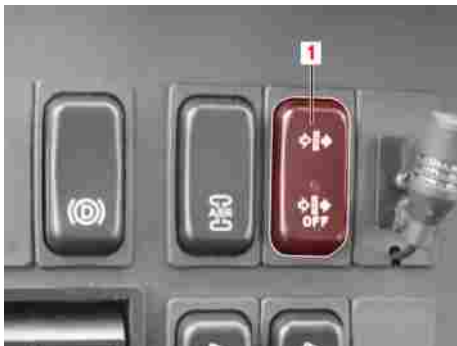



M54.00-2129-71

- ▶ Press and hold the upper section of “Manual regeneration” pushbutton (1) for approximately 3 seconds.

i **Note:**

Manual regeneration cannot be started unless the engine oil and exhaust gas temperatures are sufficiently high, the AdBlue® is not frozen and the system is functioning normally.

The indicator lamp  in the instrument cluster comes on and engine speed is increased.

When regeneration has finished, the indicator lamp  in the instrument cluster goes out and engine speed drops to idling speed.

i **Note:**

Regeneration will be aborted automatically if you engage a gear, release the parking brake or activate the regeneration inhibitor by pressing the lower section of the “Regeneration inhibitor” pushbutton.

i **Note:**

Engine speed drops to idling speed if the process is aborted.

i **Note:**

Regeneration cannot be started unless all necessary operating conditions have been fulfilled, e.g. engine oil or exhaust gas temperatures sufficiently high. If the on-board computer prompts manual regeneration at low outside temperatures, start the regeneration process before the vehicle is parked. If you were to park

the vehicle without initiating regeneration, you would not be able to start the regeneration process manually until after a subsequent engine warm-up phase. If you were to park the vehicle without initiating regeneration and the AdBlue® were frozen, you would not be able to start the regeneration process manually until after a thawing period of up to 60 minutes.

Operating/malfunction displays: fuel system/exhaust gas cleaning system

Operating/malfunction displays: fuel system/exhaust gas cleaning system

Fuel reserve



Fuel level below approximately 10% of tank capacity

AdBlue level



If the level in the AdBlue supply tank falls to approximately 33%, the icon above appears on the screen in conjunction with a yellow warning level malfunction message to remind the driver that an AdBlue top-up is due.

Exhaust gas cleaning malfunction



The malfunction indicator lamp lights up in the event of a malfunction in the exhaust gas cleaning system (SCR system).



Note:

The indicator lamp is located above the display screen in the instrument cluster.



Danger.

Have the malfunction rectified by an OMNIplus Service Partner immediately.

Fault in the exhaust gas cleaning system



The malfunction indicator lamp flashes in the event of a fault in the exhaust gas cleaning system (display if permissible NOx values exceeded) or if the AdBlue supply tank runs empty. If the malfunction message was triggered by the AdBlue supply tank running empty, it is necessary to top up the AdBlue level immediately. If the AdBlue supply tank has run empty, the driver must have actively acknowledged the AdBlue level operating display (see above) at some time previously.

Function description: accident data recorder (ADR) (option)

**Note:**

The indicator lamp is located above the display screen in the instrument cluster.

**Danger.**

Have NOx faults rectified immediately by an OMNIplus Service Partner.

Engine torque reduction

Engine torque is reduced to approximately 60 % in the event of a NOx fault (display if permissible NOx values exceeded). In this situation, a fault is also present in the exhaust gas cleaning system, i.e. the malfunction indicator lamp flashes. If the fault was caused by the AdBlue supply tank running empty, the AdBlue level operating display (see above) is also displayed. The AdBlue supply tank must be filled immediately.

**Danger.**

Have NOx faults rectified immediately by an OMNIplus Service Partner.

Function description: accident data recorder (ADR) (option)

- ▶ The accident data recorder (ADR) is a system for detecting and recording accidents and driving events, e.g. pulling away against a kerb or sudden braking.
- ▶ The ADR is activated automatically when the ignition is switched on.

**Note:**

The ADR remains active for 3 days after the ignition has been switched off and continues to register all vehicle movements (e.g. parking collisions).

Function description: accident data recorder (ADR) (option)



M54_00-1502-71

- ▶ As soon as the ignition is switched on, the ADR carries out a self-test and provides audible notification of the current operating status or the presence of a hardware fault.

i Note:

A brief, one-off audible signal (buzzer in the control panel) (4) indicates that the ADR is ready for operation.

i Note:

Indicator lamp (2) lighting up and a brief, one-off buzzing sound means that at least one event is stored.

i Note:

A sequence of four long buzzes indicates that the ADR has detected a parking collision. Check your vehicle for damage.

i Note:

Eight short buzzes mean that the memory of the ADR is almost full to capacity. Export the events and have the memory cleared.

i Note:

Ten short buzzes mean that the ADR has malfunctioned. Similarly, a malfunction is present if no signal sounds.

- ▶ Following any critical traffic or accident situation, it is possible to record an entry manually.

i Note:

When pushbutton (1) is pressed following an accident, the event (approximately 43 seconds before, during and after the accident) is stored and remains write-protected for an extended period.

Brake system safety precautions

Brake system safety precautions

**Caution:**

The braking characteristics of the bus may change if a yellow warning level malfunction in the brake system appears on the instrument cluster display screen. Adopt a particularly cautious driving style. Have the malfunction rectified as soon as possible by an OMNIplus Service Partner.

**Danger.**

The braking characteristics of the bus have changed if a red warning level malfunction in the brake system is displayed. Pedal travel may increase under braking. ABS has been disabled. Stop the bus immediately and disable it (traffic conditions permitting). Have the malfunction rectified by an OMNIplus Service Partner immediately.

Emergency braking

- ▶ In the event of danger, depress the brake pedal fully.

**Note:**

If you brake heavily at a speed of over 30 mph (50 km/h) and Brake Assist is active, the brake lamps will flash rapidly. This provides a warning to road users behind the vehicle.

Braking and stopping

- ▶ Whenever the bus is driven over long downhill stretches, you should make use of the braking effect of the engine by shifting into a lower gear. To relieve the service brake of load, use the integrated retarder in accordance with the manufacturer's operating instructions.

**Note:**

Except for emergencies, the service brake does not usually need to be applied sharply.

**Danger.**

Always apply the parking brake before you disembark. On uphill and downhill gradients, you must also chock the wheels and turn the steering towards the kerb.

Brakes with anti-locking protection

- ▶ Switch off the engine using the ignition switch.

Brakes with anti-locking protection

- ▶ In the event of danger, the brake pedal should be fully depressed. This guarantees that all wheels are regulated and the bus decelerates optimally.
- ▶ On a slippery road surface, you should also declutch so that the braking effect of the engine cannot affect the ABS control intervention.



Note:

The retarder is deactivated automatically for the duration of an ABS control intervention.



Danger.

The anti-locking protection of ABS does not relieve the driver of the responsibility for adopting a driving style which takes traffic and road conditions into account. While the directional stability and steerability of the bus are improved under braking, ABS is not able to avert the consequences of, for example, driving at an

unsafe distance behind a vehicle in front or driving too fast through bends.



Danger.

If the bus is towing a trailer that does not have ABS, this trailer could be overbraked if the brakes were applied with maximum force. In this event, the driver must keep the trailer in view by checking the rear-view mirror. The bus equipped with ABS remains steerable, thereby enabling the driver to keep the entire vehicle combination stable.

Applying the parking brake

and this operating symbol appears on the screen at the same time.

Applying the parking brake

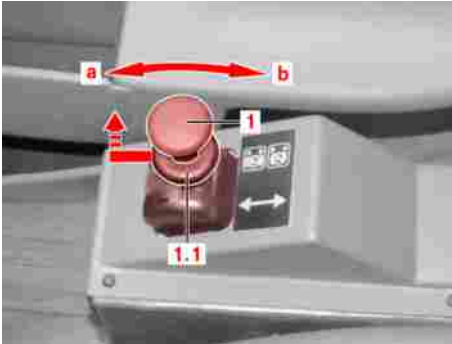

M42.00-0854-71

- Pull hand lever (1) out of released position (a) and into engagement in applied position (b).

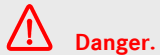

Danger.

Do not apply the parking brake unless the bus is stationary. Always apply the parking brake before you leave the driver's area. On steep uphill and downhill gradients, you should also chock the wheels and turn the steering towards the kerb.



Danger.

With the parking brake applied, ABS can no longer perform its intended function - risk of skidding.



Note:

A warning tone sounds if the ignition is switched off without the parking brake engaged.



Danger.

Check the hand lever for full engagement. To do so, attempt to press the hand lever in the “release” direction (a) without pulling release ring (1.1) out of the detent position. The lever must not move.



The parking brake indicator lamp lights up on the instrument panel

Releasing the parking brake

Releasing the parking brake

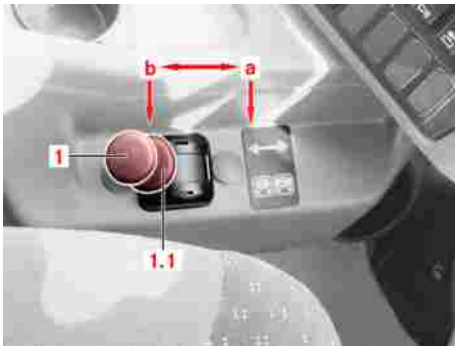

M42_00-0323-01

- ▶ Pull release ring (1.1) out of the detent position (b) and move hand lever (1) as far as the stop towards the “Release” position (a).

The indicator lamp and operating symbol must go out.



Note:

To guarantee a faultless release of the parking brake, the supply pressure must be at least 6.3 bar. If the parking brake indicator lamp does not go out even if there is sufficient supply pressure available, there is a defect in the brake spring cylinder circuit or emergency release circuit. Have the brake system checked by an OMNIplus Service Partner immediately.

Emergency braking in the event of failure of both brake circuits



Danger.

A failure in brake circuits 1 and 2 will jeopardise the operating safety and road-worthiness of the bus. Stop the vehicle immediately (traffic conditions permitting). Have the brake system checked by an OMNIplus Service Partner immediately.



Note:

In the event of a failure in brake circuits 1 and 2, it is possible to initiate emergency braking using the parking brake lever.

EBS brake system (system description)

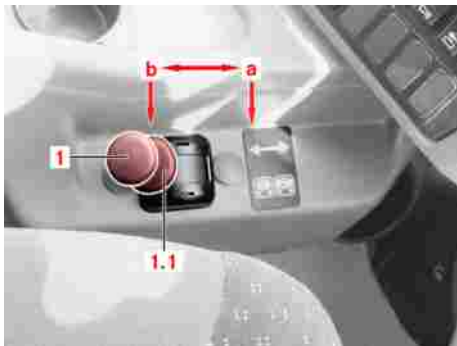

M42_00-0323-01

- ▶ Pull release ring (1.1). Pull lever (1) slowly towards applied position (b) and hold it in the desired position to prevent it from automatically returning to released position (a).



Danger.

If it is necessary to perform emergency braking using the parking brake, do not allow the parking brake lever to engage in the parking position. Keep release ring (1.1) in the applied position.

The bus is braked at the rear wheels only.



Note:

Parking brake lever (1) can be moved rearwards to any position to enable the driver to prevent the rear wheels from locking and to moderate the braking effect.



Danger.

Risk of accident. Applying the parking brake deactivates the anti-lock braking system (ABS). You should exercise even more caution when driving on slippery roads because there would be a risk of rear wheels locking.

EBS brake system (system description)

The electronic brake system (EBS) controls the vehicle's braking behaviour. The anti-lock braking system (ABS) and acceleration skid control (ASR) functions are part of the electronic brake system (EBS).

EBS helps to achieve a more rapid braking effect at the wheels. ABS prevents the wheels from locking above a speed equivalent to walking pace, regardless of the road conditions.

EBS comprises two circuits: a purely pneumatic brake circuit and a superimposed electropneumatic brake circuit.

Each wheel is equipped with sensors that continuously record the rate of brake pad wear. An overly worn brake pad is indicated on the display screen by a service notification and by a yellow alert with the "Brake pad" symbol.

Under partial braking, the braking pressures are adapted between the front axle and rear axle as a function of the brake

Acceleration skid control (ASR)

pad thickness to ensure even wear of the brake pads.

Acceleration skid control (ASR)

Acceleration skid control prevents the drive wheels from spinning when pulling away or accelerating, regardless of road surface conditions.



Danger.

Acceleration skid control does not relieve the driver of the responsibility for adopting a driving style which takes traffic and road conditions into account. The bus may skid out of control if ASR has been switched off and the drive wheels start to spin.

Brake Assist

Brake Assist interprets a dangerous situation from the speed with which the brake pedal is depressed and immediately generates maximum braking force. Brake Assist acts to minimise braking distances.

Electronic Stability Program (ESP)

Electronic Stability Program (ESP)

Dynamic handling control (FDR) acts to prevent the bus from skidding or tilting (subject to the laws of physics), regardless of vehicle load and road surface conditions, and particularly in critical driving situations (e.g. sudden evasive manoeuvre or high cornering speed). This is achieved by selective braking of individual wheels or, where necessary, all wheels. Combined with acceleration skid control (ASR), this system is called the Electronic Stability Program (ESP). ESP remains operational even when the service brake is applied or a continuous brake is active.

**Danger.**

RISK OF ACCIDENT. The Electronic Stability Program (ESP) does not relieve the driver of the responsibility for adopting a driving style which takes traffic and road conditions into account. The ability of ESP to restabilise the bus is subject to the laws of physics. The bus may skid out of control if the Electronic Stability

Program (ESP) has been deactivated and the drive wheels start to spin.

**Note:**

In wintry conditions, optimum performance of the Electronic Stability Program (ESP) cannot be achieved unless winter tyres (M+S) are fitted.



M42.00-0852-71

**Note:**

It is recommended that the Electronic Stability Program (ESP) be deactivated using ESP OFF pushbutton (1) if traction problems are experienced when driving with snow chains fitted or over loose surfaces (e.g. sand or gravel).

Operating/malfunction displays: brake system

Operating/malfunction displays: brake system

Circuit 1 supply pressure



If the supply pressure in circuit 1 falls below 6.8 bar, a red warning level malfunction is shown on the screen. At the same time, the red parking brake indicator lamp lights up in the instrument cluster. The malfunction warning is not cleared until the pressure has risen back above 7.2 bar.



Danger.

The braking characteristics of the bus have changed if a red warning level malfunction is displayed. Pedal travel may increase under braking. ABS has been disabled. Stop the bus immediately and disable it (traffic conditions permitting). Have the malfunction rectified by an OMNIplus Service Partner immediately.

Circuit 2 supply pressure



If the supply pressure in circuit 2 falls below 6.8 bar, a red warning level malfunction is shown on the screen. At the same time, the red parking brake indicator lamp lights up in the instrument cluster. The malfunction warning is not cleared until the pressure has risen back above 7.2 bar.



Danger.

The braking characteristics of the bus have changed if a red warning level malfunction is displayed. Pedal travel may increase under braking. ABS has been disabled. Stop the bus immediately and disable it (traffic conditions permitting). Have the malfunction rectified by an OMNIplus Service Partner immediately.

Brake circuit 1 or 2 pressure sensor malfunction



The supply pressures in circuits 1 and 2 are monitored by sensors. A red warning level malfunction is shown on the screen if a sensor in at least one circuit fails. The display of the supply pressure affected alternates between the minimum value (0 bar) and the maximum value (12 bar) in a 1 second cycle. At the same time, the red parking brake indicator lamp lights up in the instrument cluster.



Danger.

The braking characteristics of the bus have changed if a red warning level malfunction is displayed. Pedal travel may increase under braking. ABS has been disabled. Stop the bus immediately and disable it (traffic conditions permitting). Have the malfunction rectified by an OMNIplus Service Partner immediately.

Operating/malfunction displays: brake system

Circuit 3 supply pressure

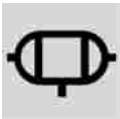

If the supply pressure in circuit 3 falls below 6.3 bar, a yellow warning level malfunction is shown on the screen. This malfunction warning is not cleared until the pressure has risen back above 6.6 bar.



Danger.

The braking characteristics of the bus may change if a yellow warning level malfunction in the brake system appears on the instrument cluster display screen. Adopt a particularly cautious driving style. Have the malfunction rectified as soon as possible by an OMNIplus Service Partner.

Parking brake applied



If the parking brake is applied, this is indicated by this icon in the “Betriebsanzeige Fahren” (Driving operating display) menu on the screen. At the same time, the red parking brake indicator lamp lights up in the instrument cluster.

Continuous braking OFF



The bus is equipped with a retarder, which provides additional braking force to supplement the service brake and is activated whenever the brake pedal is depressed (brakes management). The proportion of braking output contributed by the retarder during this combined braking action is reduced if the speed of the bus falls below 20 km/h. The

braking effect of the retarder is restored when the bus is subsequently braked at speeds of over 25 km/h. This function can be switched off using the continuous brake OFF switch on the instrument panel. This is indicated by this icon in the “Betriebsanzeige Fahren” (Driving operating display) menu on the screen.

Bus stop brake active

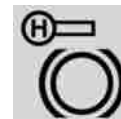

This symbol is shown on the instrument cluster display screen whenever the bus stop brake is active. It is also shown whenever the drive-off lock is active (one or more doors are open).



Note:

Neither the bus stop brake nor the drive-off lock can be deactivated unless the doors are closed and the bus stop brake switch has been switched off. The “Ready to depart” symbol is shown on the display screen.

Activating the slip increase function of ASR (acceleration skid control)



Danger.

Always apply the parking brake correctly before you leave the driver's area. Risk of accident. To park the bus, always apply the parking brake. If necessary (e.g. on steep uphill or downhill gradients), chock the wheels as an additional measure to prevent the bus from rolling away.

Ready to depart



This symbol appears as soon as all the doors are closed (drive-off lock with door open) or if the bus stop brake is active. The symbol goes out and the bus stop brake/drive-off lock is deactivated as soon as the accelerator pedal is depressed.

Bus stop brake malfunction or emergency release switch operated



This symbol appears on the instrument cluster screen if the sealed emergency release switch (red, sealed security cap) is operated or if control of the bus stop brake/drive-off lock is interrupted.



Danger.

Have the brake system checked as soon as possible by an OMNIplus Service Partner.

Activating the slip increase function of ASR (acceleration skid control)



Note:

This function is available only in vehicles without Electronic Stability Program (ESP) (option).



M42_00-0540-71

- ▶ Press pushbutton (1) with the ignition switch switched on in position 2.



Slip increase is activated. This icon appears on the instrument cluster display screen.



Danger.

Risk of accident. When the slip increase function is active, the bus may become unstable at the driven axle in the event of unfavourable road conditions: accelerate carefully.



Danger.

Risk of accident. The slip increase does not relieve the driver of the responsibility for adopting a driving style which takes traffic and road conditions into account.



Note:

It is recommended that slip increase be activated under specific conditions (e.g. snow chains, pulling away under extreme conditions) because the wheel speed at which engine torque is reduced in the event of spinning wheels on the driven axle will be increased.

- ▶ Pressing pushbutton (1) again or switching the ignition switch off and then back on again deactivates slip increase.

Operating/malfunction displays:
ABS/ASR

Brake pad wear



An overly worn brake pad is indicated on the screen by a service notification and a yellow warning level malfunction alert.



Danger.

The braking characteristics of the bus may change if a yellow warning level malfunction in the brake system appears on the instrument cluster display screen. Adopt a particularly cautious driving style. Have the malfunction rectified as soon as possible by an OMNIplus Service Partner.

Operating/malfunction displays: ABS/ASR

Brake pad wear indicator electronics



This icon and a yellow warning level malfunction are displayed if the connection to the electronics system (control unit) of the brake pad wear indicator is malfunctioning or not available.

ABS/ASR malfunction



In the event of an ABS/ASR failure or malfunction, a red or yellow warning level malfunction, depending on fault severity, is displayed.



Danger.

The wheels could lock, especially on a slippery surface - risk of skidding.



Danger.

The braking characteristics of the bus may change if a yellow warning level malfunction in the brake system appears on the instrument cluster display screen. Adopt a particularly cautious driving style. Have the malfunction rectified as soon as possible by an OMNIplus Service Partner.



Danger.

The braking characteristics of the bus have changed if a red warning level malfunction is displayed. Pedal travel may increase under braking. ABS has been disabled. Stop the bus immediately and disable it (traffic conditions permitting). Have the malfunction rectified by an OMNIplus Service Partner immediately.

Acceleration skid control (ASR) active



ASR is activated automatically if the drive wheels on one or both sides start to spin. An active ASR intervention is indicated by this icon in the "Betrieb-sanzeige Fahren" (Driving operating display) menu on the screen. If the drive wheels on one side start to spin, they will be braked automatically. - If the drive wheels on both sides start to spin, engine power output will be reduced automatically.



Danger.

RISK OF ACCIDENT. Acceleration skid control does not relieve the driver of the responsibility for adopting a driving style which takes traffic and road conditions into account.

ASR (acceleration skid control) slip increase



Pressing the “ASR slip increase” push-button when pulling away increases the wheel speed threshold above which engine torque is actively reduced to prevent the wheels on the driven axle from spinning. This results in improved traction in specific situations (e.g. snow chains, pulling away under extreme conditions).



Note:

This icon appears on the instrument cluster display screen.



Danger.

RISK OF ACCIDENT. When the slip increase function is active, the bus may become unstable at the driven axle in the event of unfavourable road conditions: accelerate carefully.

Brake pad wear sensor fault (2-axle bus)



This icon appears on the display screen in conjunction with a yellow warning level malfunction if the brake pad wear sensor has a fault.



Note:

If the icon does not go out even if you switch the ignition starter switch to OFF and back to ON, have the malfunction rectified by an OMNIplus Service Partner.



Note:

Example of an icon for a fault on the right-hand side of the driven axle on a 2-axle bus.

Brake pad wear sensor fault (3-axle bus)

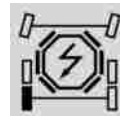

This icon appears on the display screen in conjunction with a yellow warning level malfunction if the brake pad wear sensor has a fault.



Note:

If the icon does not go out even if you switch the ignition starter switch to OFF and back to ON, have the malfunction rectified by an OMNIplus Service Partner.

Electronic Stability Program (ESP) (function description)



Note:

Example of an icon for a fault on the left-hand side of the trailing axle on a 3-axle bus.

Electronic Stability Program (ESP) (function description)

Functions:

- Electronic Stability Program (ESP) function description
- Initialisation phase
- Handling in the event of understeering
- Handling in the event of oversteering

Electronic Stability Program (ESP) function description

The Electronic Stability Program (ESP) is an extension of the Electronic Brake System (EBS), which already features the anti-lock braking system (ABS) and acceleration skid control (ASR). If the Electronic Stability Program (ESP) detects a critical driving situation, automatic control interventions stabilise the bus by:

- reducing engine power output
- selectively braking individual wheels
- applying the brakes at all wheels



Note:

The yellow ESP indicator lamp lights up while the Electronic Stability Program (ESP) is intervening.



Note:

Dynamic handling control (FDR) is active only at speeds of over 10 km/h. Dynamic handling control (FDR) is deactivated whenever reverse gear is selected.



Note:

The Electronic Stability Program (ESP) is deactivated automatically in the event of an ESP malfunction or a technically related malfunction in the Electronic Brake System.

Electronic Stability Program (ESP) (function description)

Initialisation phase

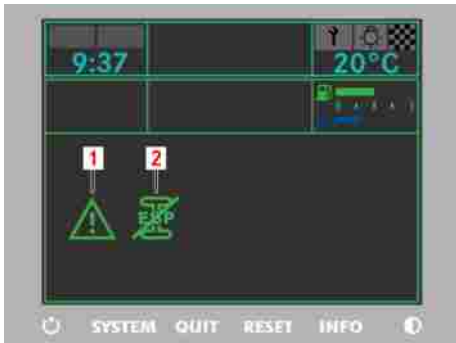

M54.00-2109-71

Whenever the ignition starter switch is switched to ON, the Electronic Stability Program (ESP) undergoes an initialisation process that lasts until the first few metres have been driven and the sensors are checked for correct function. Dynamic handling control (FDR) is not yet functional during the initialisation phase, although acceleration skid control (ASR) is operational. If the system determines that correct operation is guaranteed, initialisation is completed and the system is ready for operation. The initialisation

phase is indicated by symbol (2) as an operating display with no warning lamp.

Handling in the event of understeering

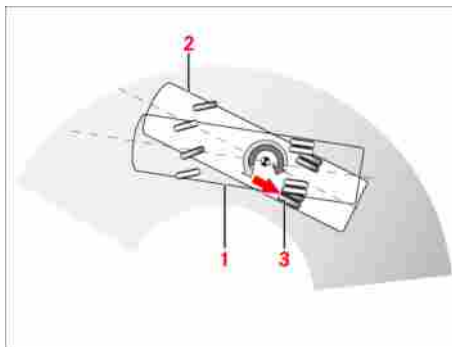

M42_25_0003_01

The front axle of the bus deviates from steered course (1) towards the offside of the road (2). Selective braking of the rear wheel on the nearside (3) restabilises the bus.



Note:

The illustration shows a 2-axle bus as an example. In the case of 3-axle buses equipped with RAS, the 3rd axle is regulated separately as necessary.

Handling in the event of oversteering

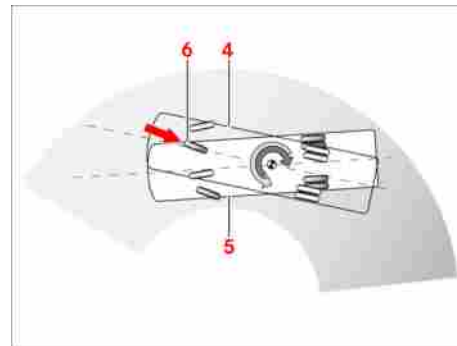

M42_25_0002_01

The bus breaks out at the rear axle. The bus deviates from steered course (4) and turns towards the near side of the road (5). Selective braking of the front wheel on the offside (6) restabilises the bus.

Deactivating the Electronic Stability Program (ESP)



Note:

The illustration shows a 2-axle bus as an example. In the case of 3-axle buses equipped with RAS, the 3rd axle is regulated separately as necessary.

Deactivating the Electronic Stability Program (ESP)



M42.00-0852-71

- ▶ Press ESP OFF pushbutton (1).



Note:

Pressing “ESP OFF” pushbutton (1) again or switching the ignition starter switch to OFF and back to ON reactivates the Electronic Stability Program (ESP).



Danger.

RISK OF ACCIDENT. The bus may skid out of control if the Electronic Stability Program (ESP) has been deactivated and the drive wheels start to spin.



Note:

It is recommended that the Electronic Stability Program (ESP) be deactivated using ESP OFF pushbutton (1) if traction problems are experienced when driving with snow chains fitted or over loose surfaces (e.g. sand or gravel).



The control functions of the dynamic drive control (FDR) and acceleration skid control (ASR) are disabled. The “ESP OFF” icon appears on the display screen.

Operating/malfunction displays: brake system

Brake pad wear



An overly worn brake pad is indicated on the screen by a service notification and a yellow warning level malfunction alert.



Danger.

The braking characteristics of the bus may change if a yellow warning level malfunction in the brake system appears on the instrument cluster display screen. Adopt a particularly cautious driving style. Have the malfunction rectified as soon as possible by an OMNIplus Service Partner.

Brake system malfunction



If a speed sensor fault was detected during the last drive cycle, a yellow warning level malfunction is displayed on the screen together with this icon. This continues to be shown until the static and dynamic system tests have been completed.



Danger.

The braking characteristics of the bus may change if a yellow warning level malfunction in the brake system appears on the instrument cluster display screen. Adopt a particularly cautious driving style. Have the malfunction rectified as soon as possible by an OMNIplus Service Partner.

ABS/ASR malfunction



In the event of an ABS/ASR failure or malfunction, a red or yellow warning level malfunction, depending on fault severity, is displayed.



Danger.

The wheels could lock, especially on a slippery surface - risk of skidding.



Danger.

The braking characteristics of the bus may change if a yellow warning level malfunction in the brake system appears on the instrument cluster display screen. Adopt a particularly cautious driving style. Have the malfunction rectified as soon as possible by an OMNIplus Service Partner.

Operating/malfunction displays: brake system



Danger.

The braking characteristics of the bus have changed if a red warning level malfunction is displayed. Pedal travel may increase under braking. ABS has been disabled. Stop the bus immediately and disable it (traffic conditions permitting). Have the malfunction rectified by an OMNIplus Service Partner immediately.

Acceleration skid control (ASR) active

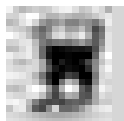

ASR is activated automatically if the drive wheels on one or both sides start to spin. An active ASR intervention is indicated by this icon in the "Betriebsanzeige Fahren" (Driving operating display) menu on the screen in conjunction with the yellow warning lamp. If the drive wheels on one side start to spin, they will be braked automatically. - If the drive wheels on both sides start to

spin, engine power output will be reduced automatically.



Danger.

RISK OF ACCIDENT. Acceleration skid control does not relieve the driver of the responsibility for adopting a driving style which takes traffic and road conditions into account.

Electronic Stability Program (ESP) active

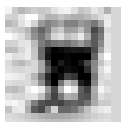

If the Electronic Stability Program (ESP) is active, the control intervention and therefore the critical driving condition is indicated on the instrument cluster screen by this icon in conjunction with the yellow warning lamp.



Note:

This symbol appears in the event of an intervention by dynamic handling control (FDR) and by acceleration skid control (ASR).



Note:

During the initialisation phase of dynamic handling control, this icon appears on the screen as a normal operating display (without the warning lamp). At this time, dynamic handling control is not yet functional even though acceleration skid control (ASR) is ready for operation.



Danger.

RISK OF ACCIDENT. The Electronic Stability Program (ESP) does not relieve the driver of the responsibility for adopting a driving style which takes traffic and road conditions into account. The ability of ESP to restabilise the bus is subject to the laws of physics.

Deactivating ESP

The Electronic Stability Program (ESP) can be deactivated using the ESP OFF pushbutton on the instrument panel. The dynamic handling control (FDR) and acceleration skid control (ASR) functions are also disabled. This is indicated in the "Betriebsanzeige Fahren" (Driving operating display) menu on the screen by this icon:

**Note:**

Press the pushbutton again or switch the ignition starter switch to OFF and back to ON to reactivate the Electronic Stability Program (FDR and ASR).

**Danger.**

RISK OF ACCIDENT. The bus may skid out of control if the Electronic Stability Program (ESP) has been deactivated and the drive wheels start to spin.

ESP malfunction

A malfunction in the dynamic handling control system (FDR) is indicated on the instrument cluster screen by this icon in conjunction with the yellow warning lamp.

**Note:**

Other brake system functions may continue to work correctly. If any of these fail, a separate fault message will be displayed.

**Danger.**

The braking characteristics of the bus may change if a yellow warning level malfunction in the brake system appears on the instrument cluster display screen. Adopt a particularly cautious driving style. Have the malfunction rectified as soon as possible by an OMNIplus Service Partner.

Circuit 1 supply pressure

If the supply pressure in circuit 1 falls below 6.8 bar, a red warning level malfunction is shown on the screen. At the same time, the red parking brake indicator lamp lights up in the instrument cluster. The malfunction warning is not cleared until the pressure has risen back above 7.2 bar.

Operating/malfunction displays: brake system



Danger.

The braking characteristics of the bus have changed if a red warning level malfunction is displayed. Pedal travel may increase under braking. ABS has been disabled. Stop the bus immediately and disable it (traffic conditions permitting). Have the malfunction rectified by an OMNIplus Service Partner immediately.

Circuit 2 supply pressure



If the supply pressure in circuit 2 falls below 6.8 bar, a red warning level malfunction is shown on the screen. At the same time, the red parking brake indicator lamp lights up in the instrument cluster. The malfunction warning is not cleared until the pressure has risen back above 7.2 bar.



Danger.

The braking characteristics of the bus have changed if a red warning level malfunction is displayed. Pedal travel may increase under braking. ABS has been disabled. Stop the bus immediately and disable it (traffic conditions permitting). Have the malfunction rectified by an OMNIplus Service Partner immediately.

Brake circuit 1 or 2 supply pressure sensor malfunction



The supply pressures in circuits 1 and 2 are monitored by sensors. A red warning level malfunction is shown on the screen if a sensor in at least one circuit fails. The display of the supply pressure affected alternates between the minimum value (0 bar) and the maximum value (12 bar) once every second. At the same time, the red parking brake indicator lamp lights up in the instrument cluster.



Danger.

The braking characteristics of the bus have changed if a red warning level malfunction is displayed. Pedal travel may increase under braking. ABS has been disabled. Stop the bus immediately and disable it (traffic conditions permitting). Have the malfunction rectified by an OMNIplus Service Partner immediately.

Circuit 3 supply pressure



If the supply pressure in circuit 3 falls below 6.3 bar, a yellow warning level malfunction is shown on the screen. This malfunction warning is not cleared until the pressure has risen back above 6.6 bar.

**Danger.**

The braking characteristics of the bus may change if a yellow warning level malfunction in the brake system appears on the instrument cluster display screen. Adopt a particularly cautious driving style. Have the malfunction rectified as soon as possible by an OMNIplus Service Partner.

Parking brake applied



If the parking brake is applied, this is indicated by this icon in the "Betriebsanzeige Fahren" (Driving operating display) menu on the screen. At the same time, the red parking brake indicator lamp lights up in the instrument cluster.

Continuous braking OFF



The bus is equipped with a retarder, which provides additional braking force to supplement the service brake and is activated whenever the brake pedal is depressed (brakes management). The proportion of braking output contributed by the retarder during this combined braking action is reduced if the speed of the bus falls below 20 km/h. The braking effect of the retarder is restored when the bus is subsequently braked at speeds of over 25 km/h. This function can be switched off using the continuous brake OFF switch on the instrument panel. This is indicated in the "Betriebsanzeige Fahren" (Driving operating display) menu on the screen by this icon.

Bus stop brake active



This symbol is shown on the instrument cluster display screen whenever the bus stop brake is active. It is also shown whenever the drive-off lock is active (one or more doors are open).

**Note:**

The bus stop brake or the drive-off lock cannot be deactivated unless the doors are closed. The "Ready to depart" symbol is shown on the display screen.

**Danger.**

Always apply the parking brake correctly before you leave the driver's area. Risk of accident. To park the bus, always apply the parking brake. If necessary (e.g. on steep uphill or downhill gradients), chock the wheels as an additional measure to prevent the bus from rolling away.

Operating 230/400 V systems (option)

Ready to depart



This symbol is displayed as soon as all the doors are closed. The symbol goes out and the bus stop brake/drive-off lock is deactivated as soon as the accelerator pedal is depressed.

Bus stop brake OFF



This symbol appears on the instrument cluster screen if the sealed emergency release switch (red, sealed security cap) is operated or if control of the bus stop brake/drive-off lock is interrupted.



Danger.

Have the brake system checked as soon as possible by an OMNIplus Service Partner.

Operating 230/400 V systems (option)

Special safety precautions must be taken when operating 230/400 V systems; these will be described below:



Danger.

Maintenance and repair work may only be carried out by personnel who have undergone the appropriate special training.

▷ The system manufacturer's safety and operating information must be observed without fail.



Danger.

Residual current devices fitted in the bus must be function-tested at regular intervals.

The following safety precautions are an absolute requirement if the 230/400 V system is to be supplied by an outside feed:

Fitting the skibox (option)



Note:

Check any extension lead used for damage before plugging it in.



Note:

The networks to which the 230/400 V system is connected must have protection in the form of a residual current device. Otherwise, plug in an external RCD as an adapter.



Note:

Check the correct operation of this RCD by pressing the test button. Only then should you connect the 230/400 V system of the bus to the mains supply.

Fitting the skibox (option)



Danger.

The skibox may only be transported, stored and assembled by using the sub-assemblies and fastening elements that are designed for that purpose.



Danger.

The installation of a skibox changes the bus length and any installed reversing monitor (park pilot) no longer functions.

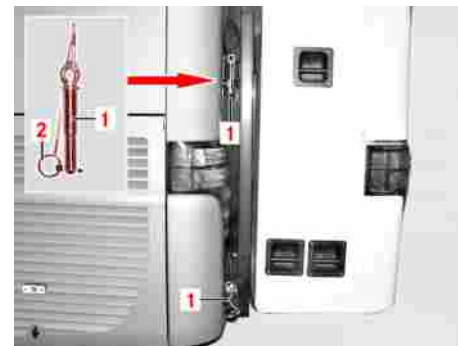

M88_00-0019-01

- ▶ The skibox is fitted to the bus by pinning the four swivel bearings on the left and right-hand side of the outer frame to the bearing pedestals on the bus using pins secured with split pins (1).



Note:

A fork lift truck should be used to raise the box to the correct height to ease assembly onto the bus.

Fitting the skibox (option)

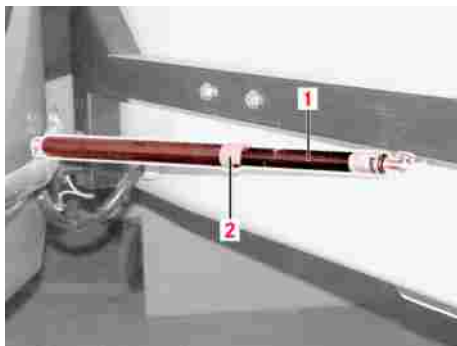

M88_00-0021-01

- ▶ Only ever stake the lower locating eyes with one pin at a time - never two at once.

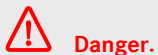

Danger.

Risk of injury. Make sure that the rear gas strut (1) prestresses the bar.

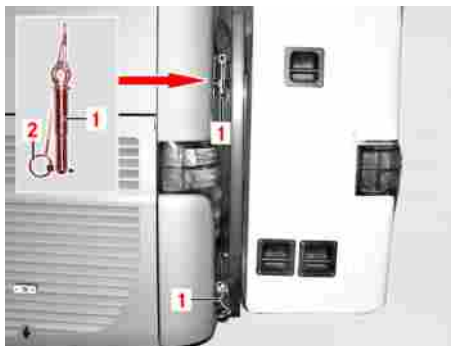

M88_00-0019-01

- ▶ The skibox can only be fitted to buses upon which the correct brackets are installed.



Note:

The electrical connection must be established between the bus and skibox once the skibox has been mounted.



Danger.

Before the bus is driven, it is necessary to check that all pins (1) are firmly seated and correctly secured by split pin (2).



Danger.

All lighting equipment must be checked for correct operation before the bus is driven. In addition, it is necessary to check that the rear foglamp only works on the skibox and no longer on the bus.



Danger.

The skibox cover must be closed and locked when the bus is being driven.

Swivelling the skibox (option)

Swivelling the skibox (option)



Caution:

Before the box is swivelled it must firstly be unloaded (follow instructions on the sticker on the skibox frame).



M88_00-0019-01

- ▶ Pull both locating pins (1) on the left-hand side when viewed in the direction of travel (after removing securing split pin (2)) and swivel the box to the right side until the gas strut has reached its end position and the catch for preventing the box from swivelling back unintentionally has snapped in place.

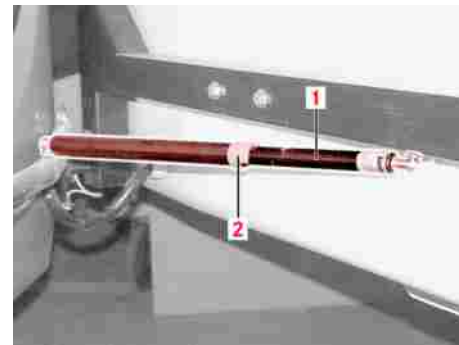

M88_00-0021-01

- ▶ This catch (2) (orange-yellow push handle on the gas strut (1)) must firstly be raised to allow the box to swivel back.
- ▶ Reinsert the locating pins and secure with securing split pins.

Additional operating instructions for the skibox (option)

Additional operating instructions for the skibox (option)



Danger.

The permissible gross vehicle weight must not be exceeded. (Observe the instructions on the sticker inside the skibox.)



Danger.

After the skibox has been loaded, the belts over the support arms must be lashed firmly over the retaining frames in order to secure the load.



Caution:

The use of corrosive soaps for skibox cleaning and care is not permitted (observe the manufacturer's instructions). If an unacceptable amount of dirt has accumulated on the skibox, you should clean it using water and a car shampoo. The use of a high-pressure cleaner is permitted provided you operate it and treat the skibox with care.

- ▶ To adjust the height of the support arms, remove the fasteners first.



Danger.

Whenever the height has been adjusted, the respective fastener must be refitted to the support arm and clipped into the wall rail.

- ▶ Pull the folding step for loading and unloading out of the retaining tubes, hook it in using the hooks and fold it out.
- ▶ If there are defective bulbs in the lamp holders, they must be replaced by pulling out the connector sockets and unscrewing the bayonet fitting.

Note on maintenance work



Note:

All maintenance work is described in a separate manual. For further information, please consult your EvoBus Service Partner.

Care and cleaning



Note:

Observe the laws and regulations in all countries concerned.



Danger.

Risk of injury. Whenever work is carried out on the bus, all applicable safety regulations must be observed (e.g. operating instructions, environmental laws and regulations, occupational safety and accident prevention regulations, etc.).



Danger.

Risk of poisoning. Observe the instructions for use of the care and cleaning products.



Danger.

Risk of poisoning. Always keep care and cleaning products sealed and out of the reach of children.



Danger.

Risk of poisoning. Diesel, regular and premium-grade fuels are harmful to health. They should not be used as a cleaning product.



Danger.

Risk of fire. Diesel, regular and premium-grade fuels are highly flammable. They should not be used as a cleaning product.



Danger.

Do not use round-spray jets to clean tyres or suspension air bags. The pulsating jet of water could cause concealed damage to the tyre substructure or suspension air bags. This damage would not become

apparent until much later and could cause the tyre or suspension air bag to burst. You could then lose control of your bus and cause an accident, which could result in injury to yourself and others.



Caution:

Do not work with high-pressure cleaners or steam cleaners in the region of axle seals (e.g. hubs, drive flange) and axle breathers. In automatic vehicle washes, make sure that these areas will not be severely subjected to jets of water.



Caution:

We recommend that only tested and approved care products should be used. Information about acceptable care products can be obtained from your OMNIplus Service Partner.

Care/cleaning of light-alloy wheels



Caution:

For cleaning work in the engine compartment, the use of cleaning agents containing acetone or chloroethylene is prohibited.



Caution:

If you are using a steam cleaner to perform cleaning work in the engine compartment, do not aim the jet directly at belt tensioners or idler pulleys.



Caution:

Stone chips and impurities, especially insect remains, bird droppings, tree resins, oils and greases, fuels and tar stains, should be remedied immediately with the use of approved care products.



Caution:

The bus must be cleaned more frequently in winter to remove salt residues from road gritting.



Environmental protection

Dispose of empty containers, cleaning cloths and polishing wads in an environmentally responsible manner.

Care/cleaning of light-alloy wheels



Danger.

Observe the general information/safety precautions in this section.



Caution:

Clean light-alloy wheels regularly.

- ▶ Clean the light-alloy wheels regularly with warm water (preferably with a high-pressure cleaner) and a soft sponge.



Danger.

Do not use round-spray jets for cleaning tyres. The pulsating jet of water could cause concealed damage to the tyre substructure. Damage to the tyre substructure would not become apparent until much later and could cause the tyre to burst. You could then lose control of your bus and cause an accident, which could result in injury to yourself and others.

Care and cleaning of covers, upholstery and ceiling

- For heavy soiling, use a cleaner for light-alloy wheels.

**Note:**

Alcoa Dura-Bright® wheels need only soap and water to retain their sheen. These wheels should not be polished using a standard polish such as ALpolish.

**Note:**

Further information: Alcoa Wheel Products Europe, www.alcoawheels.com.

**Caution:**

We recommend that only tested and approved care products should be used. Information about acceptable care products can be obtained from your OMNIplus Service Partner.

**Caution:**

Do not use acidic or alkaline cleaners. They can cause corrosion to the wheel bolts (wheel nuts) or the retaining springs of the balance weights.

Care and cleaning of covers, upholstery and ceiling

Special notes on care and cleaning of covers and upholstery**Note:**

Observe the information about your upholstered furnishings and covers contained in the detailed description of the bus.

**Caution:**

Do not use cleaning products containing solvents (e.g. petroleum ether, acetone, alcohol, etc.). This would damage covers and equipment parts made of plastic or foam beyond repair.

**Caution:**

To avoid a bleaching out of colours, use only pH-neutral care and cleaning agents.

Care/cleaning of fabric covers



Note:

These notes on care also apply to cleaning of the ceiling.



Care/cleaning of fabric covers



Danger.

Observe the general information/safety precautions in this section.



Note:

Regular care and basic cleaning help to maintain the value and high-quality appearance of fabric covers. For this reason, carry out basic cleaning regularly. Carry out basic cleaning more regularly if necessary, depending on use and the level of dirt.

Basic cleaning - weekly

- ▶ Vacuum the covers thoroughly along the nap of the fabric.



Caution:

Do not use rubber vacuum nozzles or rubber attachments. These could pull threads out of the upholstered covers.

- ▶ Using a soft brush, brush the fabric along the nap.

Basic cleaning - every six months

- ▶ First carry out the weekly basic cleaning.
- ▶ Work up a foam from a mild, luke-warm soap solution (e.g. from a mild-action detergent).
- ▶ Apply the foam evenly over all the covers using a soft, slightly damp sponge.
- ▶ Wait until the freshly cleaned covers are completely dry.

**Caution:**

The covers must be completely dry before they are sat on again. Permanent pressure marks could otherwise form.

- ▶ Brush along the nap of the fabric using a soft brush, without applying pressure.

Removing stains**Caution:**

Remove dirt as soon as possible to prevent permanent stains or damage to the covers.

- ▶ Remove as much dirt as possible using a lint-free cloth.
- ▶ Using a soft sponge, work a mild, lukewarm soap solution into the dirt in circular movements from the outside in. Apply light pressure when doing this.

**Note:**

Always clean up the dirt from the outside in to prevent it from being dispersed in the fabric.

- ▶ Mop up the soap solution using a clean, soft sponge.
- ▶ Wait until the freshly cleaned areas are completely dry.

**Caution:**

The covers must be completely dry before they are sat on again. Permanent pressure marks could otherwise form.

- ▶ Finally, brush the cover and the cleaned areas using a soft brush along the nap of the fabric.

**Caution:**

If in any doubt, use a professional textile cleaning company.

Care/cleaning of micro-fibre covers

Care/cleaning of micro-fibre covers



Danger.

Observe the general information/safety precautions in this section.



Note:

Regular care and basic cleaning help to maintain the value and high-quality appearance of micro-fibre and wool covers. For this reason, carry out basic cleaning regularly. Carry out basic cleaning more regularly if necessary, depending on use and the level of dirt.

Basic cleaning - weekly

- ▶ Vacuum the covers along the nap of the fabric, without applying pressure.



Caution:

Do not use rubber vacuum nozzles or rubber attachments. These could pull threads out of the upholstered covers.

- ▶ Using a soft brush, gently brush the upholstery down along the nap of the fabric.

Basic cleaning - every six months

- ▶ First carry out the weekly basic cleaning.
- ▶ Work up a foam from a mild, lukewarm soap solution (e.g. from a mild-action detergent).
- ▶ Apply the foam evenly over all the covers using a soft, slightly damp sponge.
- ▶ Wait until the freshly cleaned covers are completely dry.



Caution:

The covers must be completely dry before they are sat on again. Permanent pressure marks could otherwise form.

- ▶ Brush along the nap of the fabric using a soft brush, without applying pressure.

Removing stains



Caution:

Remove dirt as soon as possible to prevent permanent stains or damage to the covers.



Caution:

Do not use cleaning products containing solvents (e.g. petroleum ether, acetone, alcohol, etc.). This would damage the micro-fibre covers and equipment parts made of plastic or foam beyond repair.

- ▶ Remove as much dirt as possible using a lint-free cloth.

Care/cleaning of leather covers

- ▶ Using a soft sponge, work a mild, lukewarm soap solution into the dirt in circular movements from the outside in. Apply light pressure when doing this.



Note:

Always clean up the dirt from the outside in to prevent it from being dispersed in the fabric.



Caution:

Do not use cleaning products containing solvents (e.g. petroleum ether, acetone, alcohol, etc.). This would damage the micro-fibre covers and equipment parts made of plastic or foam beyond repair.

- ▶ Mop up the soap solution using a clean, soft sponge.
- ▶ Wait until the freshly cleaned areas are completely dry.



Caution:

The covers must be completely dry before they are sat on again. Permanent pressure marks could otherwise form.

- ▶ Finally, brush the cover and the cleaned areas using a soft brush along the nap of the fabric.



Caution:

If in any doubt, use a professional textile cleaning company.

Care/cleaning of leather covers



Danger.

Observe the general information/safety precautions in this section.



Caution:

To avoid leaving chalky outlines or water marks, use only distilled water for cleaning.



Caution:

Minimise exposure to direct sunlight to avoid colour fading.

Care/cleaning of leather covers



Note:

Regular care and basic cleaning help to maintain the value and high-quality appearance of leather covers, as well as the long-term durability and suppleness of the leather. For this reason, carry out basic cleaning at least four times a year. Carry out basic cleaning more regularly if necessary, depending on use and the level of dirt.

Basic cleaning - every quarter

- ▶ Remove coarse dirt with a very soft brush or a vacuum cleaner.



Caution:

Do not use a sharp-edged vacuuming nozzle or too hard a brush, otherwise you could damage the leather beyond repair.

- ▶ Moisten a soft, lint-free cloth with distilled water.
- ▶ Wipe leather upholstery down with a damp cloth.



Caution:

Do not use a cloth or sponge with a rough surface as this could scratch the leather upholstery or damage it beyond repair.



Caution:

To prevent the formation of permanent pressure marks, leather upholstery has to be dried off fully before subsequent use.

Removing stains



Caution:

Remove dirt as soon as possible to prevent permanent stains or damage to the covers.

- ▶ Remove as much dirt as possible using a soft, lint-free cloth.
- ▶ Gently work a mild, lukewarm soap solution into the dirty area.
- ▶ Then wipe the dirt up using a clean cloth.

- ▶ Remove the soap solution used using clean, distilled water.



Note:

All dirt and soap residues must be completely removed. If in doubt, rinse again.



Note:

To avoid the formation of outlines, not only should the mark be treated but also the wider area around it.

- ▶ Then dry the cleaned areas using a hairdryer set to medium heat, keeping it moving in a circular motion at a distance of 30 cm to 40 cm.



Caution:

The leather covers must be completely dry before they are sat on again. Permanent pressure marks could otherwise form.

**Caution:**

If in any doubt, use a professional leather cleaning company.

Leather care products**Note:**

Information about suitable leather care products can be obtained from your OMNIplus Service Partner or from a professional leather cleaning company.



Driver's area overview	88
Switches on the left section of the instrument panel	89
Switches on the right section of the instrument panel	94
Instrument cluster	96
Tachograph (installation position)	98
DTCO tachograph	100
Tachograph	102
Destination display safety precautions	102
Destination display control panel	104
Door pushbutton in the driver's area	106
Scope of tools and emergency equipment	107
Location of the fire extinguishers	107
Location of the first-aid kits	107
Tow bar location (option)	108
Location of spare mirror (option)	108
Emergency hammer (option)	108

Table of contents

Driver's rest area	110
On-board kitchenette refrigerator control panel	112
Tour guide refrigerator control panel	114
Windscreen washer reservoir	116
Seat belt reminder display	117
Exterior flaps on the Turismo 15 RHD (example of 2-axle bus)	118
Design and function description: fire detection system	119
Operating and malfunction displays: fire detection system	119

Driver's area overview

Driver's area overview



Switches on the left section of the instrument panel

No.	Description	Page
A	Switches on the left section of the instrument panel	89
B	Switches on the right section of the instrument panel	94
C	Instrument cluster	
D	Steering column switch for light and wiper functions	124
E	Steering column switch for retarder and cruise control (option)	
F	Adjustable steering column	129
G	Ignition switch	129
H	DTCO tachograph	100





No.	Description	Page
I	Parking brake and emergency release device	130
J	Master safety switch (emergency-off switch) (national variant)	152







Switches on the left section of the instrument panel







**Note:**

The overview shows the maximum utilisation of the instrument panel with switches in their designated position. To accommodate the customisation requirements of the customer, the switches may have been assigned to different positions on the instrument panel.















Switches on the left section of the instrument panel

No.	Description	Page
0	Mirror adjuster	153
1	 Windscreen roller sunblind pushbutton (option)	153
2	 Pushbutton for co-driver's roller sunblind (option)	153
3	 Diesel particulate filter (DPF) regeneration start/inhibit	154
4	 Electronic Stability Program (ESP) OFF pushbutton	154
5	 Pushbutton for GO 240-8 transmission shift system failsafe mode (option) (2/4 and N)	155

No.	Description	Page
6	 Pushbutton for GO 240-8 transmission shift system failsafe mode (option) (activation of failsafe mode and R)	155
7	 Display control pushbutton	156
8	 Driver's area lighting switch	156
9	 ADR button (accident data recorder) (option)	168
10	 Reading lamps switch	157
11	 Passenger-compartment lighting switch positions I+II	157

No.	Description	Page
12	 Night lighting switch	158
13	 Front roof hatch pushbutton - air in/air out (option)	
14	 Rear roof hatch pushbutton - air in/air out (option)	
15	 Attendant call system switch	159
16	 "School bus operation" pushbutton (option)	159
17	 Audible reverse warning feature switch (option)	159
18	 Driver's power window pushbutton	160

Switches on the left section of the instrument panel







No.	Description	Page	No.	Description	Page	No.	Description	Page
19	 Pushbutton for raising/lowering the bus	160	26	 Central locking pushbutton for the right-side luggage compartment	163	33	 Selection pushbutton for intercom in the driver's rest area/kitchenette (option)	165
20	 Normal-level pushbutton	160	27	 Creep mode pushbutton	155	34	Rotary light switch	123
21	 Passenger stop request system enabling switch	161	28	 Kitchenette enabling switch (option)	163			
22	 Switch for the driver's window heating/mirror heating	161	29	 Lavatory enabling switch (option)	163			
23	 Windscreen heating switch (option)	162	30	 Switch for electrical circuits > 100 V (option)	164			
24	 Horn changeover switch (option)	162	31	 Seat microphone switch	164			
25	 Central locking pushbutton for the left-side luggage compartment	162	32	 Pushbutton for hanging up the intercom (option)	164			

Switches on the right section of the instrument panel

Switches on the right section of the instrument panel



Switches on the right section of the instrument panel

No.	Description	Page	No.	Description	Page
35	Infrared sensor for DVD changer remote control		41	 Switch for deactivating pedal-activated continuous braking	165
36	Infrared sensor for TV tuner		42	 Bus stop brake pushbutton (option)	166
37	Control panel for audio/video system in driver's area and passenger compartment		43	 Hazard warning lamps switch	166
38	Control panel for audio/video system in driver's area and passenger compartment		44	 Door I pushbutton	167
39	Heating/ventilation/air-conditioning (HVAC) control panel	220	45	 Door II pushbutton	167
40	Cigarette lighter (option)		46	 Bus stop brake emergency release switch (option)	167

Instrument cluster

Instrument cluster

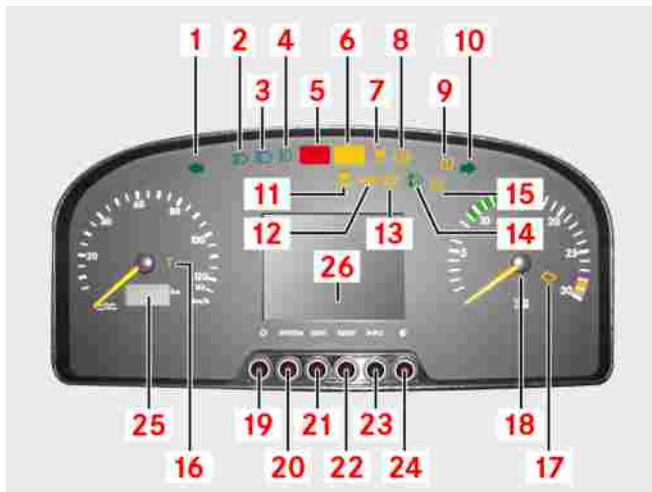

No.	Description	Page
1	Indicator lamp for the left-hand turn signals	
2	Dipped-beam indicator lamp	
3	Main-beam indicator lamp	
4	Front foglamp indicator lamp	
5	Red warning level malfunction lamp	
6	Yellow warning level malfunction lamp	
7	ESP indicator lamp	
8	Parking brake and brake system malfunction indicator lamp	

No.	Description	Page
9	Tyre pressure warning lamp	
10	Indicator lamp for the right-hand turn signals	
11	ESP lamp OFF	
12	ABS warning lamp	
13	Diesel particulate filter (DPF) indicator lamp	
14	Indicator lamp for DPF regeneration in progress	
15	Active Brake Assist OFF warning lamp	
16	Tachograph indicator lamp	
17	Exhaust gas cleaning malfunction display	

No.	Description	Page
18	Exhaust gas cleaning system (SCR system) malfunction display	
19	Selector button for trip meter/time	
20	Button for on-board diagnostics - "System"	
21	Button for on-board diagnostics - "Quit"	
22	Button for on-board diagnostics - "Reset"	
23	Button for on-board diagnostics - "Info"	
24	Button for screen brightness	

Tachograph (installation position)

No.	Description	Page
25	Total distance reading and clock display	
26	Screen (display)	

Tachograph (installation position)

Tachograph (1) is located in the lower section of the centre console to the right of the driver's area.





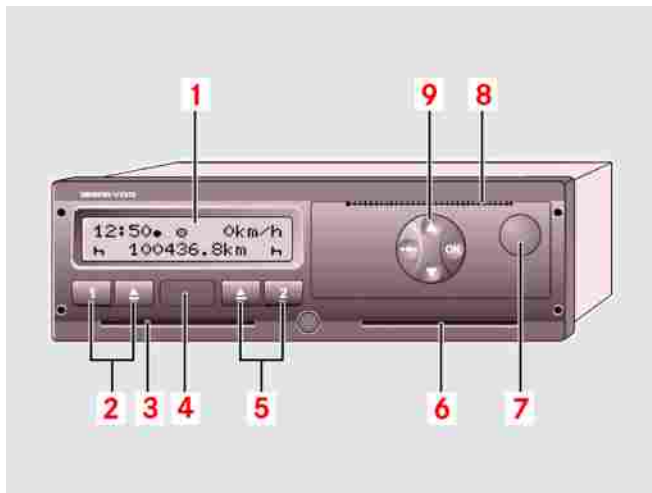

M68_00-0215-71

DTCO tachograph

DTCO tachograph



- 1 Display screen: Screen displays vary according to the operating state of the bus.
 - ▷ refer to “Display variants” in the manufacturer's operating instructions.
- 2 Key panel, driver 1
 -  **Note:**
Activity button, driver 1/card slot ejector button, driver 1
- 3 Card slot, driver 1: Driver 1, the current driver of the bus, inserts his driver card into card slot 1.
 -  **Note:**
Insert the card with the chip facing upwards in the direction of the printed arrow.
- 4 Download/calibration interface: There is an interface under the cover. This interface cannot be enabled without an inserted company card, control card or workshop card.
 - ▷ For details, refer to “Access rights for tachograph cards” in the manufacturer's operating instructions.
- 5 Key panel, driver 2
 -  **Note:**
Activity button, driver 2/card slot ejector button, driver 2
- 6 Card slot, driver 2: Driver 2, who is not currently driving the bus, inserts his driver card into card slot 2.
 -  **Note:**
Insert the card with the chip facing upwards in the direction of the printed arrow.
- 7 Printer drawer release button: This button is used to release the printer drawer, for example, for inserting a new roll of paper.
- 8 Tear-off edge
- 9 Menu buttons: Buttons for entering, displaying or printing data.
 - ▷ Refer to “Calling up menu functions” in the manufacturer's operating instructions.

Tachograph

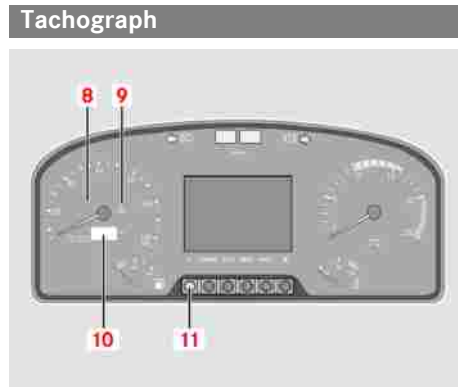

M68_00-0121-01

8 Speed display

9 Warning lamp

When lit, this means that there is a message on the tachograph display screen. Driver symbol + fault code = operator error (card missing or inserted incorrectly). Fault code = system fault (contact a service centre).

10 Display field for total distance recorder, time, trip meter

11 Selection button for time, trip meter

Press this button briefly to change the display (10) between the time and trip meter. Press and hold to reset the trip meter to 0.

Destination display safety precautions

▷ For notes on safety and operation, also refer to the manufacturer's operating instructions.

Destination display control panel

Destination display control panel

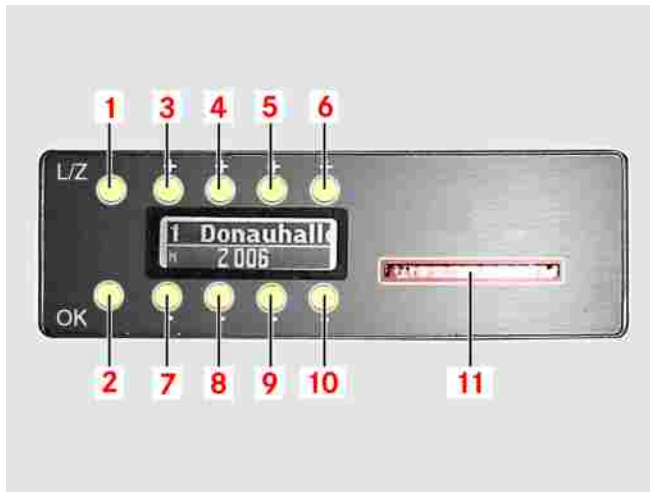

Destination display control panel

Route and/or destination numbers (3 or 4-digit numbers) are entered by the driver using the control panel for the destination display. Button 1 can be used to toggle between the route and destination numbers protocol. The active protocol is displayed on the control panel's display screen. Each digit can be increased or decreased. Pressing button 2 sends the set number in the protocol selected to the displays (front, side and rear). This number represents the route and/or destination number of the bus.

**Note:**

Switch on the ignition switch before operation.

**Note:**

The data last displayed are stored so that the last settings are retained following a power supply interruption.

Button 1

Route/destination protocol selection

Button 2

Confirmation of the selected message

Button 3

To increase the thousands digit

Button 4

To increase the hundreds digit

Button 5

To increase the tens digit

Button 6

To increase the ones digit

Button 7

To decrease the thousands digit

Button 8

To decrease the hundreds digit

Button 9

To decrease the tens digit

Button 10

To decrease the ones digit

Load slot (11)

Using the PCMCIA card (short: PC card), which is inserted into the load slot, it is possible to load customer-specific data or software and store it to the control unit. The following message appears on the control panel's display screen following a successful transfer: DOWNLOAD OK. The following message appears if the data could not be transferred: NO VALID DATA.

Door pushbutton in the driver's area

Door pushbutton in the driver's area

Door pushbutton for front right door (I) and centre right door (II) (10) with integrated warning lamps (locator lighting also ON when Lights ON).



Note:

The warning lamp lights up when: - a door is open - a door is not fully closed (door not in the catches).



Note:

The warning lamp flashes in the following situations: - the emergency switch is activated - the operating pressure is too low (depressurised bus door) - the door is open and the speed of the vehicle is more than 3 km/h - the door malfunctions.



Danger.

The doors do not operate if the display flashes. Do not move the bus if a warning lamp in the door pushbutton lights up or a yellow or red warning is shown on the display screen. Otherwise, a red warning appears on the display screen and the warning buzzer sounds.



Note:

A door cannot be operated unless the ignition is ON, the bus is stationary and the doors have been unlocked.



M72_00-0332-71

Scope of tools and emergency equipment

Tools and emergency equipment:

- Warning triangle
- Hydraulic jack 10 t maximum load with base board (observe the manufacturer's operating instructions).
- Hydraulic jack 5 t maximum load (3-axle buses only) (observe the manufacturer's operating instructions).
- Ramp
- Wheel chock
- WAF 27/32 socket spanner
- Towing bolt/towing coupling
- Crank for emergency operation of the driver's window
- Tool box (containing spare bulbs, valve connector, tyre inflation hose, torch and warning lamp etc.) (option)

Location of the fire extinguishers

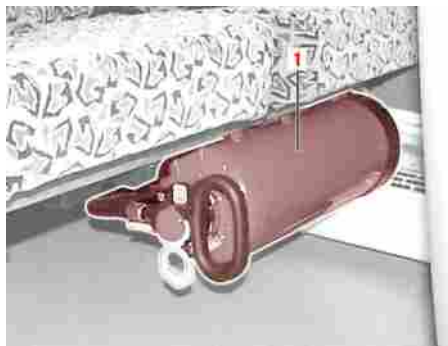

M86_00-0055-01

A hand fire extinguisher (1) is located under the first row of seats on the right when viewed in the direction of travel.



Note:

Check the inspection plate and have the fire extinguisher tested by an authorised person if necessary.

Location of the first-aid kits

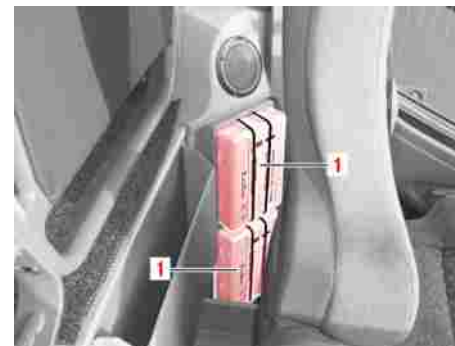

M86_00-0126-01

First-aid kits (1) are fitted behind the driver's seat on the left-hand side.



Note:

Check the expiry dates of the contents of the first-aid kit every year, and replace them if necessary.

Tow bar location (option)

Tow bar location (option)

The tow bar is bolted into the left-side luggage compartment to the rear of the front axle.

Location of spare mirror (option)



M88_00-0009-01

There is a replacement mirror (1) in the left-side luggage compartment immediately to the rear of the front axle. It is designed to act as an emergency mirror only.

Loosen 4 screws (2) to enable you to remove the mirror.

▷ For “Removing the exterior mirror/fitting the emergency mirror”, refer to the “Practical advice” section of the Operating Instructions.

Emergency hammer (option)

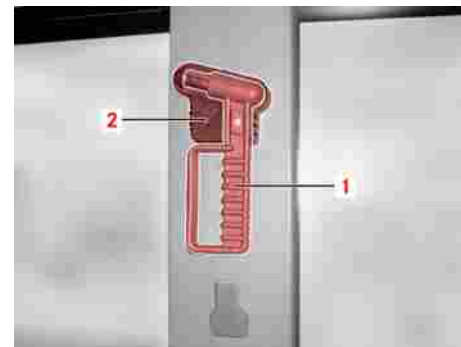

M86_00-0304-71

- ▶ Pull out emergency hammer (1) with the tamper-evident seal from bracket (2).

The emergency hammer is ready for use.



If the vehicle is equipped with an electronic anti-theft alarm system (option), this symbol appears on the display screen in conjunction with

a yellow alert when an emergency hammer has been removed.

Driver's rest area

Driver's rest area

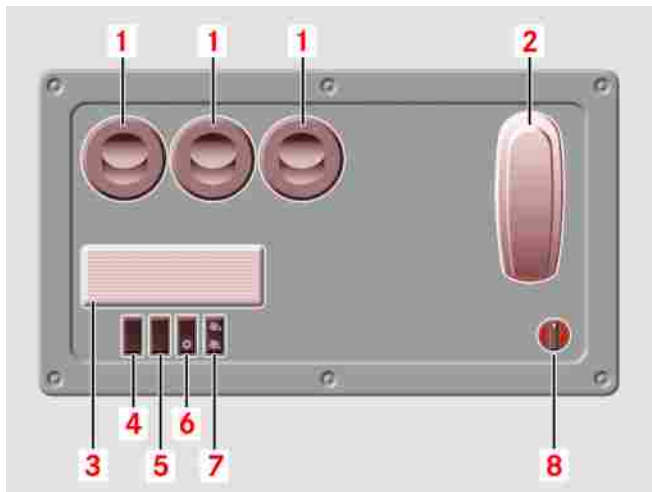

- 1 Ventilation flaps
- 2 Intercom (connection to the driver)
- 3 Interior light
- 4 Not assigned
- 5 Not assigned
- 6 Not assigned
- 7 Switch for ventilation blower speed I and II
- 8 Heating controller

On-board kitchenette refrigerator control panel

On-board kitchenette refrigerator control panel



- 1 Refrigerator control panel
- 2 Display
- 3 Refrigerator on/off button
- 4 Refrigerator ON LED
- 5 Desired temperature selector buttons
- 6 Button for activating temperature adjustment

**Note:**

Press and hold until the desired value currently set is displayed. Then adjust the temperature using buttons (5).

Tour guide refrigerator control panel

Tour guide refrigerator control panel

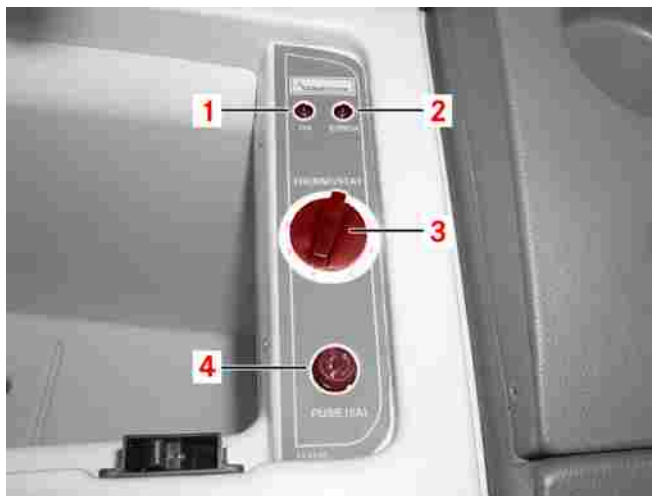

- 1 Refrigerator on indicator lamp
- 2 Malfunction lamp
- 3 Thermostat controller
- 4 Catch

Windscreen washer reservoir

Windscreen washer reservoir

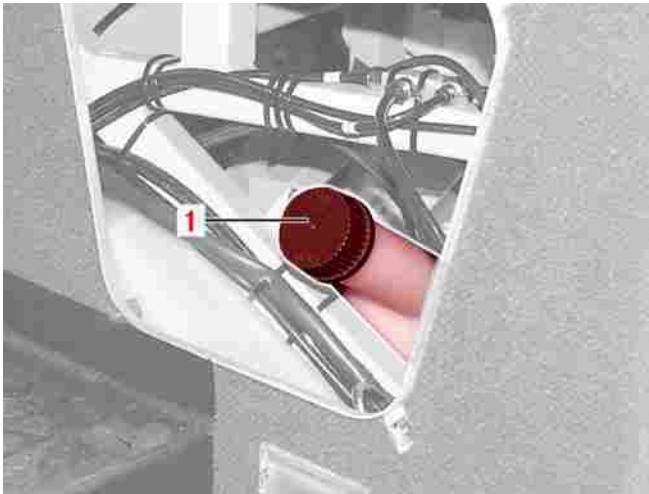

- 1 Windscreen washer reservoir filler opening

**Note:**

The windscreen washer reservoir is accessible through a flap in the front right doorway. To remove the cover, loosen the 4 quick-release locks anti-clockwise.

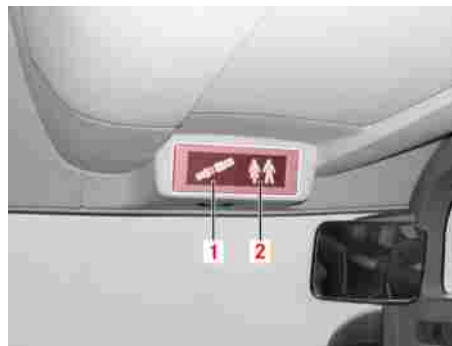
Seat belt reminder display**Seat belt reminder display**

M54_00-0978-01

With the ignition switched on and the doors closed, “Fasten seat belts” symbol (1) on the right-hand side at the front of the passenger compartment is displayed for 5 minutes after the bus has pulled away.

Exterior flaps on the Tourismo 15 RHD (example of 2-axle bus)

Exterior flaps on the Tourismo 15 RHD (example of 2-axle bus)

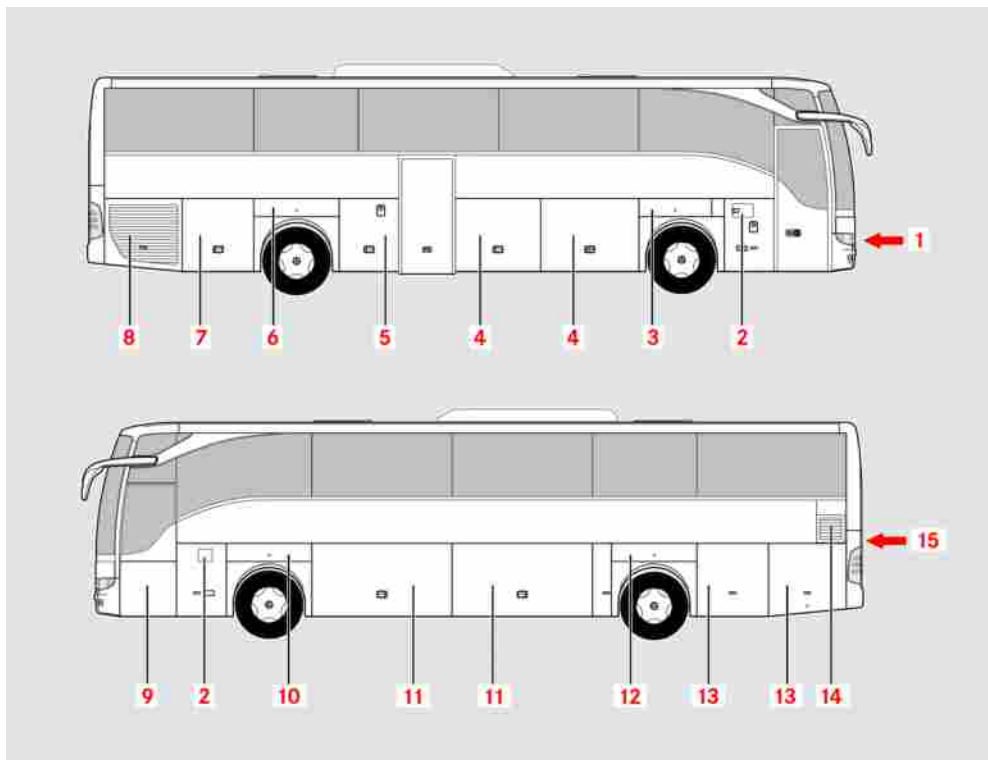

Design and function description: fire detection system

- 1 Spare wheel
- 2 Fuel tank / AdBlue reservoir
- 3 Stowage compartment / vehicle tool kit (in 3-axle buses, above the driven axle)
- 4 Luggage compartment/lavatory
- 5 Luggage compartment/multi-purpose room/driver's rest area
- 6 Auxiliary switch panel (in 3-axle buses, above the trailing axle)
- 7 Auxiliary heating, stowage compartment
- 8 Radiator, fan
- 9 Main switch panel
- 10 Batteries (in 3-axle buses, above the trailing axle), electrics
- 11 Luggage compartment
- 12 Stowage compartment
- 13 Exhaust system
- 14 Engine air intake
- 15 Engine compartment

Design and function description: fire detection system

The main components of the fire detection system are the detection agent tank and the detection line. The detection agent tank is filled with nitrogen gas and Glysantin. The detection line is connected to the detection agent tank. The end of the detection line is sealed. The pressure (approximately 24 bar) of the detection agent tank therefore acts on the detection line at all times. The pressure of the detection agent tank is monitored by a pressure switch. In the event of a fire in the engine compartment, the detection line melts and the nitrogen gas and Glysantin escapes from the detection agent tank. The pressure switch on the detection agent tank triggers a warning signal that is displayed to the driver in the form of a fire alarm notification.

Operating and malfunction displays: fire detection system

Fire detection system malfunction



In the event of a fire detection system failure or malfunction, a yellow warning level malfunction is displayed on the screen in conjunction with this icon.



Caution:

If a yellow warning level malfunction is displayed, it is permissible to drive on carefully but the bus should be checked by an OMNIplus Service Partner at the earliest opportunity.

Fire detection system triggered



A triggering of the fire detection system (e.g. due to a fire in the engine compart-

Operating and malfunction displays: fire detection system

ment) is indicated by this icon on the screen in conjunction with a red warning level malfunction. A signal sounds.



Danger.

Risk of accident. If this alert is displayed, bring the vehicle to an immediate halt (road and traffic conditions permitting), open all the doors and urge the passengers to disembark. Then operate the master safety switch and apply the parking brake. Disembark and implement or arrange further measures.

Rotary light switch	123
Steering column switch for light and wiper functions	124
Steering column switch for retarder and cruise control (overview)	124
Adjustable steering column	129
Ignition switch	129
Parking brake and emergency release device	130
Basic settings menu on display screen	131
Brightness setting of the display screen and instrument lighting	132
Display screen in the instrument cluster	133
Calling up and interpreting the fuel consumption indicator (option)	140
Air suspension safety precautions	142
Raising/lowering the bus	142
Normal level	143
Activating/deactivating axle load transfer for trailing axle (3-axle buses only)	144
Activating/deactivating the bus stop brake (option)	145
Activating/deactivating the drive-off lock (option)	146

Table of contents

Important information on the steering system	147
Turning the steering wheel when the bus is stationary	147
Activating the attendant call system	148

Rotary light switch

combines the following functions:

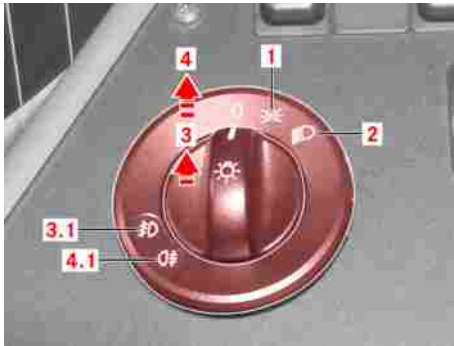

M54_00-1248-71

- 0 Lights switched off/daytime driving lights switched on (country-specific)

**Note:**

Buses with daytime driving lights (country-specific): as soon as the engine is switched on, the side lamps, the dipped-beam headlamps and the licence plate lamps switch on automatically.

- 1 Side lamps
- 2 Headlamps: Dipped-beam headlamps/main-beam headlamps (depending on the steering column switch position) with the ignition switch in position 2 (drive position)

**Note:**

In countries where traffic drives on the other side of the road to that in the country where the vehicle was registered, there is a risk of oncoming traffic being dazzled by the asymmetric dipped-beam headlamps. When driving in these countries, observe country-specific regulations (mask headlamps if necessary).

- 3 Front foglamps (pull switch to 1st detent): In addition to the side lamps, dipped-beam headlamps or main-beam headlamps if the ignition switch has been switched to ON. Indicator lamp (3.1) lights up.
- 4 Rear foglamp (pull switch to 2nd detent). In addition to the front foglamps. Indicator lamp (4.1) lights up. When a trailer or skibox is connected, the rear foglamp on the towing vehicle is disabled and only the rear foglamp connected via the trailer socket is enabled.

Steering column switch for light and wiper functions

Steering column switch for light and wiper functions

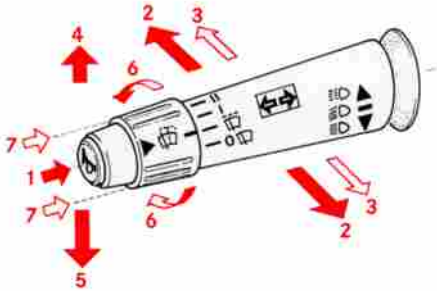

M54_00-0081-01

- 1 Horn: Press button
- 2 Indicate left and right with automatic reset: Push the switch stalk beyond the point of resistance until it clicks into position.
- 3 One-touch indicators for a lane change: Press the switch stalk only briefly (not beyond the pressure point). The turn signals flash five times.

- 4 Headlamp flasher: Pull the stalk upwards
- 5 Main-beam and dipped-beam headlamps: Stalk in basic position = dipped-beam headlamps, stalk down = main-beam headlamps
- 6 Windscreen wipers: Turn the sleeve on the switch stalk: speed 0 = off, speed INT = intermittent, speed I = normal, speed II = rapid
- 7 Wipe and wash: Push sleeve on the switch stalk towards the steering column. With windscreen wipers switched off = windscreen wipe and wash

Steering column switch for retarder and cruise control (overview)

▷ The “General information/Safety precautions” in the “Driving systems” section of the Operating Instructions must be observed.

Steering column switch for retarder and cruise control (overview)

Combined drive/brake cruise control

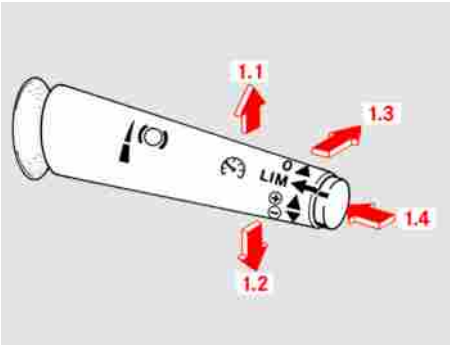

M54_00-1003-01

i **Note:**

Precondition: bus speed must be greater than 10 mph (15 km/h). The clutch and service brake pedals must be fully released and the continuous brakes must not be active.

i **Note:**

The speed is maintained constant only for as long as the braking performance of the retarder remains sufficient for this to be possible. If necessary, shift down and reduce speed.

1.1 Tap briefly (< 0.5 seconds) = current speed is set and shown on the display screen.

i **Note:**

Tap briefly again (< 0.5 seconds) = set speed is increased by 0.3 mph (0.5 km/h).

i **Note:**

Press and hold (> 0.5 seconds) = bus speed increased until switch released. When the steering column switch is released, the current speed is set as the new value.

1.2 Tap briefly (< 0.5 seconds) = current speed is set and shown on the display screen, or resumption of last stored speed.

i **Note:**

Tap briefly again (< 0.5 seconds) = set speed is reduced by 0.3 mph (0.5 km/h).

i **Note:**

Press and hold (> 0.5 seconds) = bus speed reduced until switch released. When the steering column switch is released, the current speed is set as the new value.

1.3 Cruise control is switched off and the last stored value remains stored in the control unit (until the ignition switch is switched off).

Steering column switch for retarder and cruise control (overview)



Note:

The combined drive/brake cruise control is deactivated automatically as soon as the service brake is applied with cruise control operational at this time.



Note:

If the clutch pedal is depressed, cruise control will remain active when the clutch pedal is subsequently released. However, cruise control will be deactivated if the clutch is depressed for more than 5 seconds. A short signal sounds to indicate that cruise control is in standby mode.

▷ For detailed operating information, refer to “Activating combined drive/brake cruise control” in the “Driving systems” section of the Operating Instructions.

Variable speed limiter (TempoSet)

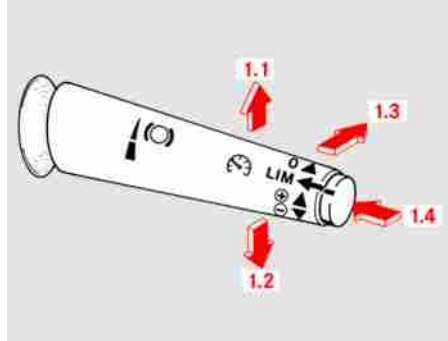

M54_00-1003-01

1.4 Tap briefly = function changeover to speed limiter (LIM). The function changeover is indicated by the “LIM” symbol on the display screen. If the steering column switch (A) is now moved to position (1.1) or (1.2), the current speed will be set as the limit speed. The set value is shown on the display screen. The driver must continue to use the accelerator pedal.



Note:

Press and hold (1.1): the limit speed that was set will be increased by increments of 3 mph (5 km/h) for as long as the switch is pressed.

Steering column switch for retarder and cruise control (overview)

**Note:**

Press and hold (1.2): the limit speed set will be decreased by increments of 3 mph (5 km/h) for as long as the switch is pressed.

**Note:**

To deactivate: combination switch to position 1.3 or activate cruise control (by pressing button (1.4)).

**Note:**

The speed limiter can be activated at speeds above 6 mph (10 km/h); between 6 mph (10 km/h) and 10 mph (15 km/h) it is always limited to 10 mph (15 km/h). It is possible to exceed the set speed temporarily by depressing the accelerator pedal beyond the stop (kickdown). If the driver takes his foot off the acceleration pedal, the limit speed set will apply once more.

**Note:**

The retarder is automatically activated if the set limit speed is exceeded by more than 4 km/h in overrun mode.

tems” section of the Operating Instructions.

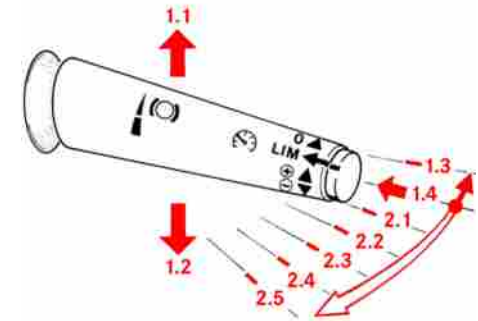
Continuous braking

M54_00-0082-01

Activating continuous braking:

**Danger.**

Do not activate the continuous brake (retarder) on a slippery road surface. The wheels could lock - risk of skidding.

▷ For detailed operating information, refer to “Activating the variable speed limiter (Temposet)” in the “Driving sys-

Steering column switch for retarder and cruise control (overview)

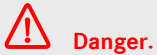

Danger.

If the accelerator pedal is operated while the continuous brakes are active, the continuous brakes are deactivated and braking output is reduced to zero.



Caution:

Always move the combination switch through each of the available stages to achieve the required braking torque (do not move it directly to the required position). It is not permitted to move the combination switch directly to the required position except in an emergency. However, it is acceptable to skip several stages at once if you are reducing the braking torque. For the optimum braking torque to be achieved, the engine should be turning within its upper speed range so that the coolant does not overheat.



Danger.

When the ABS system is working correctly, an activated continuous brake is automatically deactivated if one or both of the wheels on the driven axle threatens to lock. If an ABS malfunction message is present, there is no guarantee that this function will be carried out - risk of skidding.

2.1 - 2.2 Retarder stage 1 - 2 active

2.3 - 2.5 Engine brake, constantly open throttle, retarder stages 3 and 4 active



Note:

The interaction between the engine brake and the constantly open throttle valve depends on the brake torque currently available.

Engine speed increase

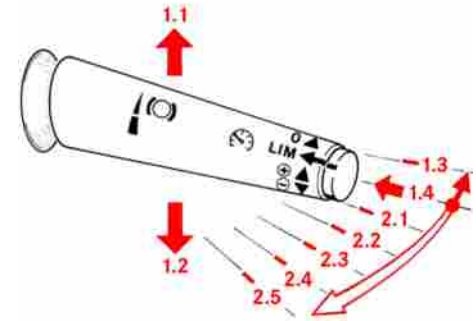

M54_00-0082-01

Precondition: bus stationary, engine running.

1.1 The engine speed can be increased up to a maximum of 750 rpm.

1.3 Engine speed increase off, normal idling speed

Adjustable steering column

Set the steering column to the release position by pressing the lower section of pushbutton (1).



Danger.

Do not make adjustments unless the bus is stationary. Lock the steering column in place after you have adjusted the steering wheel to match the driver's requirements. To do this, press the upper section of pushbutton (1).



Danger.

After the adjustable steering column has been adjusted, the driver must check that all instruments and indicator lamps are still visible.



Note:

The steering column is automatically locked in place if pushbutton (1) is not pressed for approximately 12 (+/- 5) seconds.

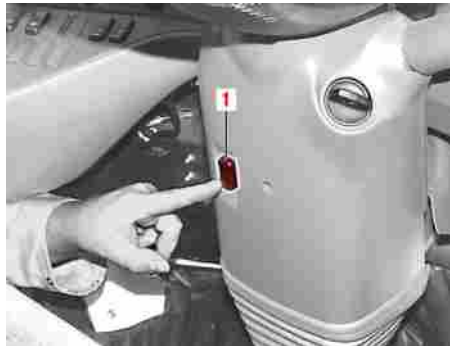

M46_00-0030-01

Ignition switch



Danger.

Never lock the steering while the bus is in motion.



Danger.

Whenever you disembark, even for a short time, always remove the key so that the bus cannot be started by children or other unauthorised persons.

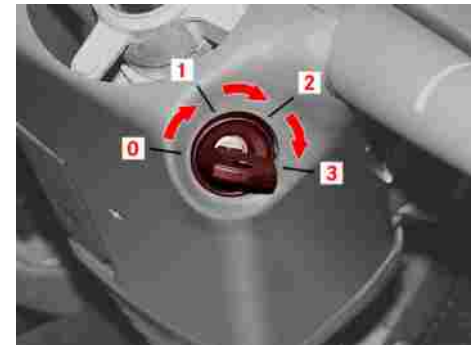

M54_00-0083-01

0 Rest position:

Parking brake and emergency release device



Note:

Insert or remove the key in this position; the side lamps can be switched on.

1 Steering unlocked



Note:

Selected consumer units can be switched on.

2 Drive position/ignition ON

3 Starting position

Parking brake and emergency release device

Parking brake valve (1) combined with the emergency release device for spring actuators



Caution:

The parking brake spring actuators require a release pressure of 5.8 to 6.4 bar. At low supply pressures, there is a risk that the brake may not be fully released, that the friction pads may make slight contact while the bus is in motion and that the brake may be subjected to unnecessarily high thermal loads. The relevant icon on the screen must go out when the parking brake is released. If the compressed-air system for the parking brake is damaged, it is possible to release the parking brake using the emergency release device: the emergency release device is combined with the parking brake valve and is operated in exactly the same way as the normal parking brake. The valve automatically switches over to the air reserve for the emergency release device and the spring actuators are released.



Caution:

Do not apply the parking brake unless the bus is stationary.



Danger.

Always apply the parking brake before you leave the driver's area.



Danger.

Check the hand lever for full engagement.



Note:

An audible warning sounds if the ignition is switched off without the parking brake engaged.

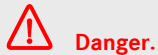

Danger.

The braking effect of ABS is cancelled if you apply the parking brake while the vehicle is in motion.



M42_00-0444-01

▷ For notes on safety and operation, refer to the “Operation” section of the Operating Instructions.

Basic settings menu on display screen



Note:

In the menu described below, it is possible to change the basic value for the display screen illumination and instrument lighting with the driving lights switched on, the volume of the turn signal buzzer, and the language setting for the display screen.

- ▶ Switch the ignition starter switch to ON.



Note:

The parking brake must be applied.

- ▶ Turn the rotary light switch to headlamps.



M54_00-0876-01

- ▶ Wait for the basic screen to appear.



Note:

Acknowledge any malfunction alerts that might appear by pressing “Quit” button (10).

- ▶ Press “Info” button (10).

The screen display shown appears.

Brightness setting of the display screen and instrument lighting



Note:

A = Display screen or instrument lighting basic value with driving lights ON



Note:

B = Turn signal buzzer volume



Note:

C = Display screen language selection

- ▶ Select the setting you wish to change by pressing "Info" button (12).



Note:

The corresponding symbol appears in green.

- ▶ Change the setting by pressing button - (9) or + (11).

- ▶ Confirm by pressing button (12).
- ▶ Exit the settings menu by pressing the "Quit" button (10).

Brightness setting of the display screen and instrument lighting



Note:

Night or daytime brightness is set depending on the position of the rotary light switch.



Note:

The values set are automatically stored when button (24) is released.

- ▶ Switch the ignition starter switch to ON.

Display screen in the instrument cluster

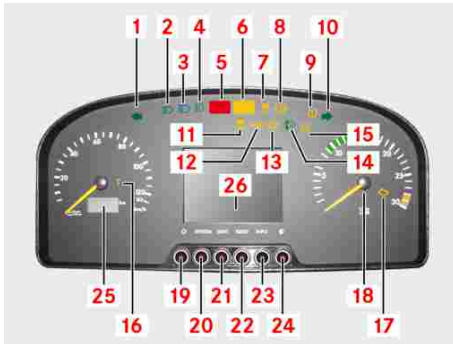

M54.00-2207-71

- ▶ Press and hold button (24).

The display screen illumination and instrument lighting are dimmed.

- ▶ Press button (24) briefly.

The display screen illumination and instrument lighting are immediately set to maximum brightness.

Display screen in the instrument cluster



M68_00-0216-71

The screen (1) is active at all times while the ignition starter switch is ON. The screen is a status indicator for showing operating and malfunction information (icons). Additionally, it can be used to display on-board diagnostics information.

To hold/scroll screen display



M68_00-0125-01

When the lower section of display control pushbutton (1) is pressed, the operating, service and malfunction displays are retrieved in sequence (exception: red warning level malfunction). When the upper section of display control pushbutton (1) is pressed, the current display mode is held. No other message will be displayed except for red warning level malfunctions. The information shown on the screen is, however, periodically refreshed. A diamond symbol in the top right corner of the screen indic-

Display screen in the instrument cluster

ates that the screen is being held. Press either the lower or upper section of the pushbutton again to allow the screen to display the next display menu.

Screen sequence at start-up



M54.00-2062-71

Whenever the ignition starter switch is switched to ON, the red warning level malfunction overview appears on the screen first, followed by the yellow warning level malfunction overview and then by the service overview. If, during the start-up, there are no malfunctions present or services due, this stage is skipped and the supply pressure

operating displays appear straight away (see illustration).

Red warning level malfunction overview



M54.00-2063-71

The red warning level malfunction overview is indicated by a flashing red warning level malfunction lamp (3). Any red warning level malfunctions that are present are indicated by means of separate operating and malfunction symbols (icons) (1). If there are no red warning level malfunctions, the screen display immediately switches over to the yellow warning level malfunction

overview, otherwise the screen display switches over to the yellow warning level malfunction overview after approximately 5 seconds.



Danger.

In the event of a red warning level malfunction, the bus must be stopped immediately (traffic conditions permitting) and an OMNIplus Service Partner must be notified.

Display screen in the instrument cluster

Yellow warning level malfunction overview



M54.00-2064-71

The yellow warning level malfunction overview is indicated by a flashing yellow warning level malfunction lamp (4). Any yellow warning level malfunctions that are present are indicated by means of separate operating and malfunction symbols (icons) (1). If there are no yellow warning level malfunctions, the screen display immediately switches over to the service overview, otherwise the screen display switches over to the service overview after approximately 5 seconds.



Caution:

In the event of a yellow warning level malfunction, it is permissible to drive on carefully but the bus should be checked by an OMNIplus Service Partner at the earliest opportunity.

Service notifications



M54.00-2065-71

Service notifications generally inform the driver that service products need to be replenished or wear parts need to be replaced. In the event of a service notification, the status indicator at the top right of the display screen lights up. Any

service tasks that are due are indicated by means of individual icons (1). If no service tasks are due, the screen display immediately switches to the supply pressure operating display.

Compressed-air supply pressure operating displays



M54.00-2066-71

The supply pressure (0 to 12 bar) for circuits 1 (front axle or trailing axle), 2 (driven axle) and 3 (auxiliary consumers) is displayed. If there is sufficient supply pressure in all circuits, the screen display changes to the engine operating display after approximately 5 seconds

Display screen in the instrument cluster

and the audible warning ceases. If the sensor signal is faulty, the screen displays toggle between the minimum and maximum value in a 1 second cycle.



Danger.

The bus must not be driven until the audible warning has ceased.

Engine operating displays



M54.00-2067-71

Engine oil pressure (1) (between 0 and 6 bar) and engine oil level (2) are displayed. After approximately 5 seconds, the screen display changes to the fuel

tank and battery operating display. If the sensor signal is faulty, the screen displays toggle between the minimum and maximum value in a 1 second cycle.



Note:

The engine oil pressure should be higher than 0.5 bar at idling speed and higher than 2 bar when the bus is being driven. A negative value (-) for the engine oil level indicates that the oil level needs to be topped up.

Battery/supply tank operating display



M54.00-2068-71

AdBlue additive supply (1) (empty 0 to full 1/1) and battery voltage (2) (0 to 32 V) are displayed. After approximately 5 seconds, the screen display changes to the Driving operating display. If the sensor signal is faulty, the screen displays toggle between the minimum and maximum value in a 1 second cycle.



Note:

An icon appears on the basic screen when the level in the AdBlue supply tank has fallen to 33% of capacity.



Note:

The battery voltage display should show 25 - 28 V when the engine is running. If this is not the case, you should visit an OMNIplus Service Partner as a matter of urgency.

Fuel consumption indicator (option)



M54.00-2069-71

Different measured values and calculated average values are shown in the fuel consumption indicator (option) in zone A (values since start) and B (values since reset).



Note:

For more detailed information, refer to "Calling up and interpreting the fuel consumption indicator" in the "Driver's area controls" section of the Operating Instructions.

Driving operating display



M54.00-2070-71

This is the basic screen normally shown when the bus is being driven, but also when stationary. In this display mode, all items of bus operating information are represented as symbols (icons).



Note:

Outside temperature (1) is shown on each screen.

Display screen in the instrument cluster

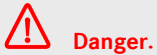

Danger.

RISK OF ACCIDENT. If the temperature display shows a temperature of around freezing point (0 °C), the road surface may be icy, especially in areas protected from the sun and on bridges. Following a sudden change in temperature, e.g. after driving out of a depot, an accurate temperature reading will be displayed only after a delay.

Red warning level malfunction



M54.00-2071-71

With the first occurrence of a red warning level malfunction, the malfunction

symbol (icon) associated with this malfunction is displayed in the centre of the screen. At the same time, a signal sounds and red warning level malfunction lamp (3) flashes.

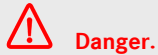

Danger.

In the event of a red warning level malfunction, the bus must be stopped immediately (traffic conditions permitting) and an OMNIplus Service Partner must be notified.

Red warning level malfunction lamp (continued)

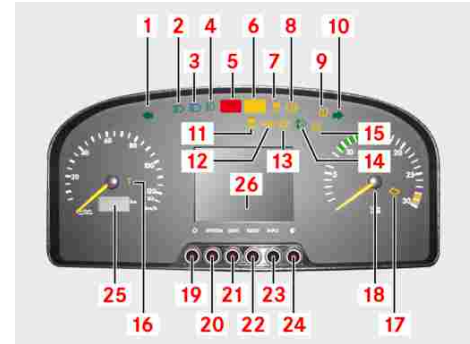

M54.00-2207-71

The malfunction can be acknowledged by pressing Quit button (21), but only if the bus is stationary and the parking brake is applied. The red warning level malfunction display is then faded into the background. This frees the screen for other messages to be displayed or queries to be made. A lit red warning level malfunction lamp (3) indicates that there are red warning level malfunctions present but they are not currently being displayed on the screen.

Yellow warning level malfunction



M54.00-2072-71

With the first occurrence of a yellow warning level malfunction, the malfunction symbol (icon) associated with this malfunction is displayed in the centre of the screen. At the same time, a signal sounds and yellow warning level malfunction lamp (4) flashes.

**Caution:**

In the event of a yellow warning level malfunction, it is permissible to drive on carefully but the bus should be checked by an OMNIplus Service Partner at the earliest opportunity.

lamp (4) indicates that there are yellow warning level malfunctions present but they are not currently being displayed on the screen.

Yellow alert in the background

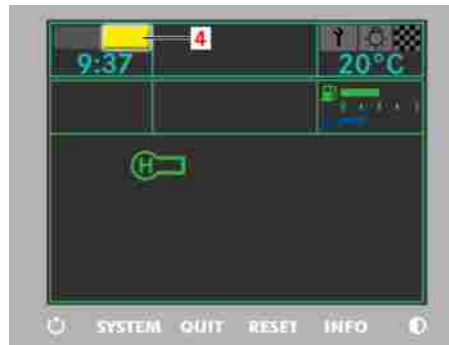

M54.00-2115-71

The yellow warning level malfunction display is faded into the background automatically after approximately 5 seconds. This frees the screen for other messages to be displayed or queries to be made. A lit yellow warning level malfunction

Calling up and interpreting the fuel consumption indicator (option)

Calling up and interpreting the fuel consumption indicator (option)



M68_00-0125-01

- ▶ To call up the fuel consumption indicator:

i Note:

Press the lower section of display control pushbutton (1) several times until the fuel consumption indicator appears.

i Note:

When the bus is stationary and the parking brake is applied, the display can also be changed using the “Quit” button below the display screen.



M54.00-2069-71

- ▶ To hold (freeze) the fuel consumption indicator:

i Note:

Press and hold the upper section of the display control pushbutton as soon as the indicator appears on the display screen. Otherwise, the display changes to the Driving operating display automatically after 10 seconds.

i Note:

When the bus is stationary and the parking brake is applied, the screen display can also be held using “Info” button (11) below the display screen.

- ▶ Interpreting the display (after start):

i Note:

The upper area of the display screen (A) shows various measured values since the last start:

Calling up and interpreting the fuel consumption indicator (option)

**Note:**

1 = Distance covered since start

**Note:**

2 = Driving time since start

**Note:**

3 = Average speed since start

**Note:**

4 = Average fuel consumption since start

► Interpreting the display (since reset):

**Note:**

The lower area of the display screen (B) shows various measured values since the last time the "Reset" button was pressed:

**Note:**

5 = Distance covered since reset

**Note:**

6 = Driving time since reset

**Note:**

7 = Average speed since reset

**Note:**

8 = Average fuel consumption since reset

► Resetting both areas of the display

**Note:**

For safety reasons, the displays cannot be reset unless the bus is stationary and the parking brake is applied.

**Note:**

The upper area of the display (after start) can be reset by briefly pressing "Reset" button (10) in the selected fuel consumption menu or by leaving the ignition starter switch switched to OFF for more than 4 hours.

**Note:**

The lower area of the display (since reset) can be reset by pressing and holding "Reset" button (10) in the selected fuel consumption menu (for more than 3 seconds).

Air suspension safety precautions

Air suspension safety precautions

The forward section of the chassis and the guidance of the driven axle have been structurally designed in such a way as to ensure that the bus remains manoeuvrable when the suspension air bags have been depressurised.

In this condition, the full weight of the vehicle body is supported by the stop buffers fitted at the forward section of the chassis and at the rear axle. These stop buffers are unladen when the suspension is at normal level and are intended only to prevent the body of the vehicle from dropping onto the axle in the event of extreme suspension compression. The stop buffers are not designed for permanent loading and cannot be used as a replacement for the normal suspension under any circumstances. The bodywork could otherwise suffer damage (cracks, etc.).



Danger.

Although the bus remains manoeuvrable while the suspension is depressurised, it must be driven no faster than walking pace to the nearest lay-by or OMNIplus Service Partner. Whenever work is carried out on the air suspension system, the body must always be supported by jacks and stands positioned at the designated points because the body of the bus could drop relatively quickly in the event of a loss of air.

Raising/lowering the bus

- ▶ Preconditions: ignition switch ON, bus stationary, doors closed, operating pressure > 6.5 bar, level control operational.
- ▶ Raise or lower the bus using the pushbutton.



Danger.

The bus must not be lowered if there are persons present in the immediate vicinity of the bus.



Danger.

Do not exceed the maximum permissible vehicle height when driving with the bus raised above normal level. In Germany, the maximum permissible vehicle height is limited to 4 metres. Observe local national regulations if the bus is operated in other countries.

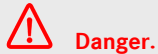
**Danger.**

The bus is not permitted to be driven faster than walking pace whenever it has been raised or lowered out of normal level.

**Note:**

The suspension air bags are deflated or inflated and the superstructure is lowered or raised by 70 mm respectively.

**Note:**

It is possible to raise or lower the bus only at speeds of up to 12 mph (20 km/h).

**Note:**

The bus returns to normal level as soon as its speed exceeds 18 mph (30 km/h).

**Note:**

As raising the bus increases the approach angle, it is advisable to raise the bus above normal level on parts of journeys involving numerous hairpin bends, for example.

**Note:**

The corresponding symbol appears on the instrument cluster display screen whenever the bus has been raised or lowered.

The bus is lowered or raised for as long as the pushbutton is pressed.

Normal level

- ▶ Preconditions: ignition switch ON, bus stationary, doors closed, operating pressure > 6.5 bar, level control operational.
- ▶ Press the pushbutton to return the bus to normal level.

**Note:**

Bus normal level (driving position).

Activating/deactivating axle load transfer for trailing axle (3-axle buses only)

Activating/deactivating axle load transfer for trailing axle (3-axle buses only)



M32_00-0182-71

- ▶ The axle load transfer of the trailing axle is activated by pressing pushbutton (1) in the driver's area.

i Note:

The axle load transfer (pull-away aid) is primarily used in the winter for pulling away or for reversing in wintry road conditions. The compression force on the driven axle is increased because the load on the trailing axle is reduced.

i Note:

After the axle load transfer has been activated, the compressed-air supply to the suspension air bags for the trailing axle is stopped. An overflow valve deflates the suspension air bags.

i Note:

The pull-away aid cannot be activated unless the ignition switch is ON and the bus is travelling at a speed of below 20 mph (30 km/h).



When the pull-away aid is active, the LED lights up in the pushbutton and the "Pull-away aid active" symbol appears on the screen.

- ▶ Press rocker switch (1) again to switch off the pull-away aid.

i Note:

The pull-away aid will be cancelled if the air pressure in the suspension air bags of the driven axle exceeds 7 bar while the bus is in motion and the axle load relief function is active. The suspension air bags are again under an equal loading.

i Note:

The pull-away aid similarly switches off if the speed of the bus exceeds 20 mph (30 km/h).

Activating/deactivating the bus stop brake (option)

Activating/deactivating the bus stop brake (option)

- ▶ Ignition starter switch ON

**Danger.**

Do not activate the bus stop brake unless the bus is stationary. The bus stop brake must not be used as a means to brake a coasting bus to a halt. The bus must never be parked with only the bus stop brake applied. Apply the parking brake at bus stops on steep uphill or downhill gradients that exceed 15 %.

**Danger.**

Always apply the parking brake correctly before you leave the driver's area.

- ▶ Press the bus stop brake pushbutton.



The wheels on the driven axle are braked with reduced pressure.

**Danger.**

If the parking brake is subsequently applied, the bus stop brake will be released. After the parking brake is released again, the bus stop brake will be reactivated after a delay. For this reason, it is essential that the service brake be applied during this time.

**Note:**

The icon above appears on the instrument cluster display screen.

**Note:**

The “Ready to depart” icon appears on the display screen at the same time.

- ▶ Depress the accelerator pedal.

The “bus stop brake” function is deactivated again and the icons on the display screen go out.

**Note:**

The bus stop brake is also deactivated if you apply the parking brake or switch the ignition starter switch to OFF.

Activating/deactivating the drive-off lock (option)

Activating/deactivating the drive-off lock (option)

- ▶ Ignition switched on
- ▶ Bus stationary



Danger.

If the drive-off lock is not used as intended, the vehicle could roll away. This could result in an accident with serious or fatal injuries. Therefore: - Always apply the parking brake before you start/stop the engine or leave the driver's area. - Do not, under any circumstances, use the drive-off lock to park the bus or to secure the bus against rolling away. - Apply the parking brake when stopping on steep uphill or downhill gradients exceeding 15 % or at bus stops on steep uphill or downhill gradients exceeding 15 %.

- ▶ One or both passenger doors open.



All wheel brakes are applied automatically with a compressed-air pressure

of 2.0 bar, the engine runs at idling speed, and it is not possible to alter the engine speed using the accelerator pedal.



Note:

This icon appears on the instrument cluster display screen.

- ▶ Close all passenger doors.



Note:

The “ready to depart” icon is shown on the display screen.

- ▶ Depress the accelerator pedal.

The drive-off lock is released as soon as the accelerator pedal is depressed. Both icons on the display screen go out.



Note:

The drive-off lock is also deactivated if you apply the parking brake or switch off the ignition.

Important information on the steering system

Important information on the steering system

The dimensions of the steering system and the mechanical steering transmission ratio were designed such that, in the event of a malfunction in the hydraulic power steering system, the effort required to turn the steering wheel would not exceed a specific value deemed by legislators to be the maximum reasonable force.

For vehicles weighing over 12 t, this maximum operating force is 450 N (400 N for vehicles between 3.5 t and 12 t) applied to the steering wheel rim in the straight-ahead position. This force must be sufficient to achieve a turning circle with a radius of 20 m at a road speed of approximately 10 km/h.

The driver must be aware that, in the event of a sudden failure in the power steering (e.g. due to a pump drive malfunction), the bus will remain steerable but considerably more effort will be required.

Since there is an extremely low probability of this situation occurring - but if it does occur, it often does so completely unexpectedly - the driver could wrongly assume that the steering system has been blocked. However, the bus does remain steerable provided the driver applies the necessary force.

This important information is intended to clarify the scenario described and prevent the driver from possibly misjudging the situation.

**Danger.**

In the event of a power steering failure, the bus becomes very difficult to steer. Have the malfunction rectified immediately by an OMNIplus Service Partner.

Turning the steering wheel when the bus is stationary

- ▶ Adhere to the instructions.

**Note:**

To prevent damage to the steering column, the following points must be observed when turning the steering wheel with the bus stationary, without hydraulic support (engine switched off) and without a turntable under the front wheels (tyres in direct contact with the ground):

- ▶ Release the steering wheel adjuster and push the steering wheel fully down. Lock the steering wheel adjuster in place. Turn the steering wheel using both hands at an angle of 90° to 180° to one another.

**Caution:**

Never have more than one person turn the steering wheel. Do not pull the steering wheel on one side only.

Activating the attendant call system



Note:

We ask the workshop in particular to note this.

Activating the attendant call system

- ▶ Press the attendant call system switch with the ignition switched on.



The LED in the switch lights up.



An icon now appears on the instrument cluster display screen whenever the attendant call button on the service set above one of the passenger seats is pressed.



Note:

A red LED on this seat's service set lights up.

Master safety switch (emergency-off switch) (national variant)	152
Mirror adjuster	153
Windscreen roller sunblind pushbutton (option)	153
Pushbutton for co-driver's roller sunblind (option)	153
Axle load transfer switch (3-axle buses only)	154
Diesel particulate filter (DPF) regeneration start/inhibit	154
Electronic Stability Program (ESP) OFF pushbutton	154
Pushbutton for GO 240-8 transmission shift system failsafe mode (option) (2/4 and N)	155
Pushbutton for GO 240-8 transmission shift system failsafe mode (option) (activation of failsafe mode and R)	155
Creep mode pushbutton	155
Display control pushbutton	156
Driver's area lighting switch	156
ADR pushbutton	157
Reading lamps switch	157
Passenger-compartment lighting switch positions I+II	157

Table of contents

Night lighting switch	158
Roof hatch pushbutton - air in/air out (option)	158
Attendant call system switch	159
“School bus operation” pushbutton (option)	159
Audible reverse warning feature switch (option)	159
Driver's power window pushbutton	160
Pushbutton for raising/lowering the bus	160
Normal-level pushbutton	160
Passenger stop request system enabling switch	161
Switch for the driver's window heating/mirror heating	161
Windscreen heating switch (option)	162
Horn changeover switch (option)	162
Central locking pushbutton for the left-side luggage compartment	162
Central locking pushbutton for the right-side luggage compartment	163
Kitchenette enabling switch (option)	163
Lavatory enabling switch (option)	163

Switch for electrical circuits > 100 V (option)	164
Seat microphone switch	164
Pushbutton for hanging up the intercom (option)	164
Selection pushbutton for intercom in the driver's rest area/kitchenette (option)	165
Switch for deactivating pedal-activated continuous braking	165
Bus stop brake pushbutton (option)	166
Hazard warning lamps switch	166
Door I pushbutton	167
Door II pushbutton	167
Bus stop brake emergency release switch (option)	167
ADR button (accident data recorder) (option)	168

Master safety switch (emergency-off switch) (national variant)

Master safety switch (emergency-off switch) (national variant)

When master safety switch (1) is operated, the engine is switched off if running. The tachograph, instrument cluster (option), interior lighting and roof hatches remain operational. Operate the emergency-off switch by pressing the red knob. Unlock the switch by turning the red knob anti-clockwise.



Danger.

Risk of accident. The emergency-off switch should not be operated except in an emergency and only with the bus stationary - never while the bus is in motion. Operation of the emergency-off switch causes the engine to switch off automatically. The power steering would consequently be disabled if the bus were in motion. Additional effort would then be required in order to steer. Furthermore, the power supply to all important electrical consumers (e.g. bus lighting, ABS, electronic transmission shift system, etc.) would be interrupted. The roadworthiness of the bus is at risk.



Note:

Additional functions may be available, depending on the national variant.



Note:

In Finland, Greece, Spain and Italy, the hazard warning lamps and interior lighting are switched on automatically. The central locking is enabled (ECE-R 36).



Note:

In France, the hazard warning lamps are enabled.



Note:

In Norway, the hazard warning lamps, interior lighting, auxiliary heating (water heater) and horn are enabled.



Note:

In Poland, the hazard warning lamps are switched on automatically.



Note:

In Austria, operating the emergency-off switch switches off the engine and interrupts the supply of power to the entire electrical system.



M54_00-0986-01

Mirror adjuster

Using this control element, it is possible to change the position of the left or right exterior mirror. Which mirror is adjusted depends on the position of adjustment button (1).



M68_00-0146-01

Windscreen roller sunblind pushbutton (option)

The pushbutton is used to raise or lower the roller sunblind. The roller sunblind is active only for as long as the pushbutton is pressed.

**Pushbutton for co-driver's roller sunblind (option)**

The pushbutton is used to raise or lower the roller sunblind. The roller sunblind is active only for as long as the pushbutton is pressed.



Axle load transfer switch (3-axle buses only)

Axle load transfer switch (3-axle buses only)

Pressing the pushbutton on the instrument panel activates the axle load transfer of the 3rd axle provided the bus is travelling at a speed of below 30 km/h. If the axle load transfer is already active, pressing the pushbutton deactivates the function. If active, the axle load transfer will be deactivated automatically as soon as the bus is travelling faster than 30 km/h. A symbol on the screen and an LED in the pushbutton indicate whether the axle load transfer is active.

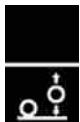

▷ For notes on safety and operation, refer to the “Driver's area controls” section of the Operating Instructions.

Diesel particulate filter (DPF) regeneration start/inhibit

Upper section of pushbutton pressed: Start DPF regeneration. Press lower section of pushbutton: Stop DPF regeneration or inhibit automatic DPF regeneration.



Electronic Stability Program (ESP) OFF pushbutton

This pushbutton deactivates the ESP function. The dynamic handling control (FDR) and acceleration skid control (ASR) functions are also disabled. This is indicated on the screen by a crossed-through ESP symbol. Pressing the pushbutton again or switching the ignition starter switch to OFF and back to ON reactivates the function.



▷ For notes on safety and operation, refer to the “Operation” section of the Operating Instructions.

Pushbutton for GO 240-8 transmission shift system failsafe mode (option) (2/4 and N)

Pushbutton for GO 240-8 transmission shift system failsafe mode (option) (2/4 and N)

While failsafe mode (option) is active, this pushbutton is used to request the gears that are available or to shift the transmission to neutral.



▷ For notes on safety and operation, refer to the “Transmission shift systems” section.

Pushbutton for GO 240-8 transmission shift system failsafe mode (option) (activation of failsafe mode and R)

This pushbutton is used to activate failsafe mode (option) or, if failsafe mode is already active, to shift into reverse gear.



▷ For notes on safety and operation, refer to the “Transmission shift systems” section.

Creep mode pushbutton

Upper section of pushbutton pressed = creep mode deactivated.

**Note:**

The creep function enables the vehicle to creep forwards independently when the service brake is released with the engine idling without the driver having to use the accelerator pedal. The vehicle crawls along at idling speed until the driver uses the service brake to stop or until the creep function is deactivated/cancelled.

**Note:**

The creep function is available at all times after an engine start and is activated after the vehicle has pulled away for the first time. Using the pushbutton, it is possible to deactivate this function in exactly the same way as it would be in the display screen menu if this menu is currently unavailable for some reason, such as when the screen is displaying camera images.

Display control pushbutton



Display control pushbutton

Causes the screen display to change or freezes the screen display



Note:

Press lower section: scroll through screen displays.



Note:

Press upper section: hold current screen display.



Driver's area lighting switch

With the ignition starter switch switched ON, the driver's area lighting can be switched on and off.



ADR pushbutton

This pushbutton is used to switch on the accident data recorder (ADR).

**Reading lamps switch**

With the switch in position 1 (down), the driver can switch on the reading lamps as additional lighting for the vehicle interior provided the ignition starter switch has been switched to ON and economy mode is not active. All the reading lamps are then switched on. With the switch in position 2 (up), the driver can enable the reading lamps for passengers provided the conditions described above have been fulfilled and, in addition, the side lamps have been switched on.

**Passenger-compartment lighting switch positions I+II**

With the switch in position 1 (down), all of the interior lighting can be switched on provided the ignition starter switch has been switched to ON and economy mode is not active. If the ignition starter switch is OFF, however, it is the night lighting that will be switched on, even if economy mode is active. With the switch in position 2 (up) and the ignition starter switch ON, the night lighting can be switched on even if economy mode is active.



Night lighting switch

Night lighting switch

Using this switch, it is possible to switch on the LED night lighting provided the side lamps are switched on.



Roof hatch pushbutton - air in/air out (option)

It is possible to move the front and rear roof hatches individually to either the air-in or air-out position using the double rocker switch provided the roof hatches have not been forced closed by air-conditioning or “smog” mode and the wind-screen wipers are not operating at speed 1 or 2. When the roof hatches are open, the indicator lamp in the switch lights up and a corresponding operating symbol (icon) is shown on the display screen. If the upper section of the pushbutton is pressed only briefly, the roof hatch moves to the air-in position. The roof hatch opens fully if the upper section of the pushbutton is pressed for longer than 1 second. If the lower section of the pushbutton is pressed only briefly, the roof hatch moves to the air-out position. The roof hatch closes if the lower section of the pushbutton is pressed for longer than 1 second.



Danger.

Do not operate the roof hatches unless you are sure that no persons are present in the area around the hatches. There is a risk of injury and entrapment if parts of the body (fingers) are in the area of movement of the roof hatches.



Attendant call system switch

Switches on the power supply for the attendant call function. A lamp in the switch lights up when the switch is pressed. An operating symbol (icon) appears on the instrument cluster display screen whenever the attendant call button at one of the passenger seats is pressed. At the same time, a red LED on this seat's service set lights up.

**“School bus operation” pushbutton (option)**

Pressing this pushbutton switches on all the turn signals on the left and right. The school bus warning lights can be deactivated using the school bus warning lights pushbutton or the turn signal switch on the steering column (indicate left or right).

**Audible reverse warning feature switch (option)**

This switch is used to switch off the audible reverse warning that would normally sound when reverse gear is engaged.



Driver's power window pushbutton

Driver's power window pushbutton

The driver's window can be opened or closed. The power window is active only for as long as the pushbutton is pressed.



Danger.

The window's range of movement should be kept clear of all obstructions (e.g. any part of your body) while the pushbutton is being pressed (particularly during closing).



Pushbutton for raising/lowering the bus

The bus is raised or lowered when the pushbutton is pressed.



▷ For notes on safety and operation, refer to the “Driver's area controls” section.

Normal-level pushbutton

Pressing this pushbutton returns the bus to normal level.



▷ For notes on safety and operation, refer to the “Driver's area controls” section.

Passenger stop request system enabling switch

This switch is used to disable the passenger stop request system. The deactivation is indicated by a corresponding icon on the instrument cluster display screen.



Switch for the driver's window heating/mirror heating

The heating for the driver's window and mirrors can be switched on using this pushbutton provided the ignition starter switch has been switched to ON and economy mode is not active. The indicator lamp in the switch lights up at the same time. The heating for the driver's window and mirrors cannot be restarted until the switch-off delay (30 minutes) has elapsed. Switching the ignition starter switch to OFF cancels the switch-off delay, and the heating for the driver's window and mirrors switches off immediately. If the economy function is activated during the switch-off delay, the heating for the driver's window and mirrors will be switched off only for the duration of the economy period. If the switch-off delay has not elapsed by the time the economy function is deactivated, the heating for the driver's window and mirrors switches back on for the period of time remaining.



Windscreen heating switch (option)

Windscreen heating switch (option)

The windscreen heating can be switched on using this pushbutton provided the ignition starter switch has been switched to ON and economy mode is not active. The indicator lamp in the switch lights up at the same time. The windscreen heating cannot be restarted until the switch-off delay (30 minutes) has elapsed. Operating the master safety switch or switching the ignition starter switch to OFF cancels the switch-off delay, and the windscreen heating switches off immediately. If the economy function is activated during the switch-off delay, the windscreen heating will be switched off only for the duration of the economy period. If the switch-off delay has not elapsed by the time the economy function is deactivated, the windscreen heating switches back on for the period of time remaining.



Horn changeover switch (option)

Changeover between horn 1 (top/electric)/horn 2 (bottom/air)



Central locking pushbutton for the left-side luggage compartment

The luggage compartment flaps can be locked or unlocked electropneumatically using the rocker switch provided the ignition starter switch has been switched to ON. The luggage compartment lighting switches on automatically provided the luggage compartment flap circuit on one side of the bus is unlocked and one of the luggage compartment flaps is open. The LED in the rocker switch provides the driver with a confirmation of the state. LED lit -> luggage compartment flaps unlocked.



Central locking pushbutton for the right-side luggage compartment

Central locking pushbutton for the right-side luggage compartment

The luggage compartment flaps can be locked or unlocked electropneumatically using the rocker switch provided the ignition starter switch has been switched to ON. The luggage compartment lighting switches on automatically provided the luggage compartment flap circuit on one side of the bus is unlocked and one of the luggage compartment flaps is open. The LED in the rocker switch provides the driver with a confirmation of the state. LED lit -> luggage compartment flaps unlocked.



Kitchenette enabling switch (option)

With the kitchenette enabled, it is possible to use the water supply, the lighting and selected basic functions.



▷ For notes on safety and operation, refer to the “On-board kitchenette” section of the Operating Instructions.

Lavatory enabling switch (option)

All functions in the lavatory cabin are available when the lavatory cabin has been enabled.



▷ For notes on safety and operation, refer to the “Lavatory” section of the Operating Instructions.

Switch for electrical circuits > 100 V (option)

Switch for electrical circuits > 100 V (option)

Using this pushbutton, it is possible to isolate electrical circuits with an effective voltage of over 100 V from the main power supply circuit.



▷ Observe the safety and operating information in the manufacturer's operating instructions.

Seat microphone switch

This switch activates the microphone at the driver's seat to enable the driver to speak to passengers through the PA system.



Pushbutton for hanging up the intercom (option)

This pushbutton is available only in conjunction with the selection pushbutton for the intercom in the driver's rest area/kitchenette (option). Pressing the upper section of the pushbutton ends the call connection with the intercom in the driver's rest area or on-board kitchenette.



Selection pushbutton for intercom in the driver's rest area/kitchenette (option)

Selection pushbutton for intercom in the driver's rest area/kitchenette (option)

When the lower section of the pushbutton is pressed, a ring tone sounds at the intercom in the on-board kitchenette. The LED in the pushbutton lights up at the same time. Once the handset has been picked up, it is possible to speak to the person in the on-board kitchenette using the swan-neck microphone regardless of whether the microphone is already switched on or not. The voice of the person in the on-board kitchenette is heard over the two front loudspeakers. When the upper section of the pushbutton is pressed, a ring tone sounds at the intercom in the driver's rest area and the LED in the pushbutton lights up. Once the receiver has been picked up, a conversation can be held in the same way. When you have finished your conversation, you should always press the upper section of the intercom pushbutton, otherwise the radio will remain muted. The LED in the pushbutton must go out.

**Danger.**

Please devote your attention primarily to road and traffic conditions.

**Danger.**

Do not use the intercom unless road and traffic conditions permit you to do so safely. Please bear in mind that your bus will cover a distance of 14 metres every second at a speed of only 50 km/h.



Switch for deactivating pedal-activated continuous braking

None of the continuous brakes available in the bus (retarder, engine brake, constantly open throttle) will be activated in addition to the service brake when the driver depresses the brake pedal. A notification (icon) showing the crossed-through "continuous brake" symbol then appears in the screen's basic menu.

**Note:**

This switch is for use mainly in wintry road conditions so that the driver can moderate the braking effect more effectively.



Bus stop brake pushbutton (option)

Bus stop brake pushbutton (option)

When the pushbutton is pressed, all wheel brakes are applied with reduced pressure. It is prohibited to activate the bus stop brake unless the bus is stationary.



Danger.

If the bus stop brake is not used as intended, the vehicle could roll away. This could result in an accident with serious or fatal injuries. Therefore: - Always apply the parking brake before you start/stop the engine or leave the driver's area (refer to the "Driver's area controls" section of the Operating Instructions).



Danger.

Do not under any circumstances use the bus stop brake as a parking brake or hillholder. - Apply the parking brake whenever you come to a stop on a steep uphill or downhill gradient of more than 15 % or pull into a bus stop on a steep uphill or downhill gradient of more than 15 %. - Do not activate the bus stop brake unless the vehicle is stationary.



▷ For notes on safety and operation, refer to the "Driver's area controls" section of the Operating Instructions.

Hazard warning lamps switch

All the turn signals on the left and right are switched on regardless of the position of the ignition starter switch. The turn signal indicator in the hazard warning lamps switch flashes and the green turn signal indicator lamps in the instrument cluster flash.



Door I pushbutton

The driver's pushbutton opens or closes the front right door. The bus must be stationary for the door to open. The open state is displayed to the driver by an indicator lamp in the driver's pushbutton and a corresponding icon on the instrument cluster display screen.



▷ For notes on safety and operation, refer to the “Opening/locking” section of the Operating Instructions.

Door II pushbutton

The driver's pushbutton opens or closes the centre right door. The bus must be stationary for the door to open. The open state is displayed to the driver by an indicator lamp in the driver's pushbutton and a corresponding icon on the instrument cluster display screen.



▷ For notes on safety and operation, refer to the “Opening/locking” section of the Operating Instructions.

Bus stop brake emergency release switch (option)

This switch is used to release the bus stop brake in an emergency or in the event of a malfunction.



Danger.

This switch has a tamper-evident seal and is intended to be operated only in the event of a malfunction in the bus stop brake or drive-off lock.



Danger.

Make absolutely sure that the parking brake is applied before you operate the bus stop brake emergency release switch. The bus could otherwise roll away.



ADR button (accident data recorder) (option)

ADR button (accident data recorder) (option)

Pressing the ADR button after an event informs the accident data recorder that the event was of particular importance and prompts the memory manager to keep the event stored in the memory for longer than normal.



Note:

The accident data recorder (ADR) is a system for detecting and recording accidents and driving events, e.g. pulling away against a kerb or sudden braking. The data are generated into an electronic report that documents the course of the event in full detail, in real time and without any possibility of fraud. The report therefore constitutes evidence that would be admissible in court.



Driver's seat	170
Grammer driver's seat control elements	172
ISRI 6860/875 driver's seat controls (option)	174
Operation of the jump seat	176
Adjusting a passenger seat	177
Using the driver's seat belt	178
Operating the jump-seat seat belt	178
Passenger-compartment-seating seat belt	179
Removing a seat squab	179
Fitting a seat squab	179
Seat belt reminder display	180
Passenger seat service set	182

Driver's seat

Driver's seat

It is essential that the following instructions be observed:



Danger.

In the interests of road safety, the driver's seat must not be adjusted when the bus is in motion.



Note:





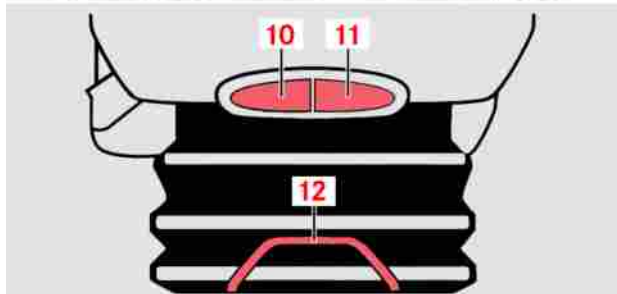
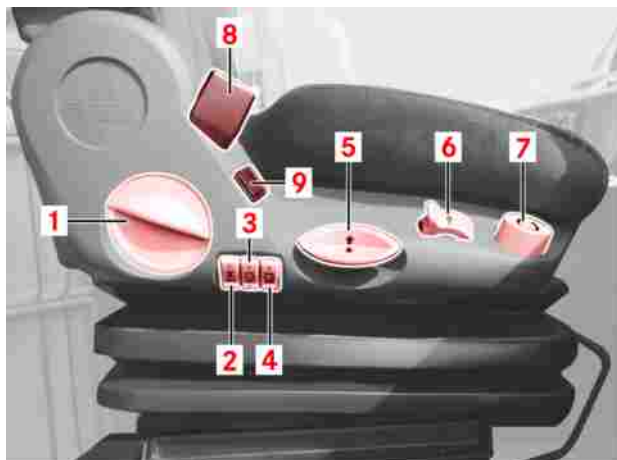

The following descriptions provide a brief overview of the control elements. In each case, the manufacturer's Operating Instructions must be observed.

Driver's seat/passenger seats

Grammer driver's seat control elements

Grammer driver's seat control elements



1	Backrest adjustment		<p> Note: (+) chamber fills up/(-) chamber empties</p>		<p> Note: Relieve the load on the backrest. Pull button upwards. The seat angle can now be adjusted.</p>
		5	Height adjustment	11	Seat cushion depth adjustment
2	Lateral support adjustment		<p> Note: Pull lever up = upwards adjustment/press lever down = downwards adjustment</p>		<p> Note: Pull button upwards. The seat cushion can now be adjusted.</p>
		6	Damper setting	12	Driver's seat fore-and-aft adjustment
3	Lumbar support (upper chamber)		<p> Note: The damper setting can be continuously adjusted between soft and hard</p>		<p> Note: Pull lever upwards. The seat can now be slid in the longitudinal direction.</p>
		7	Rapid lowering		
		8	Seat belt buckle		
		9	Seat heating/seat climate control (option)		
4	Lumbar support (lower chamber)		<p>10 Seat cushion angle adjustment</p>		

Driver's seat/passenger seats

ISRI 6860/875 driver's seat controls (option)

ISRI 6860/875 driver's seat controls (option)

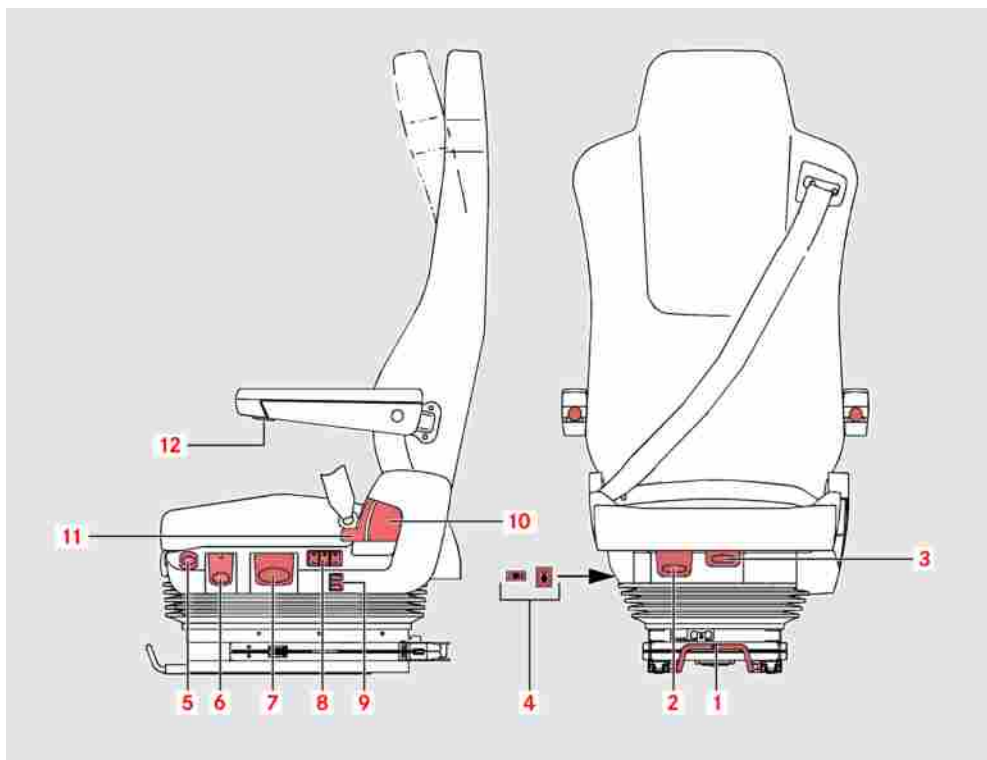

1 Driver's seat fore-and-aft adjustment



Note:

Pull lever upwards. The seat can now be slid in the longitudinal direction.

2 Tilt adjustment



Note:

Pull the handle up. Adjust the tilt angle by applying load on or relieving load from the front section of the seat cushion.

3 Seat cushion depth adjustment



Note:

Raise the lever and push the seat cushion forwards/backwards. Engage the seat cushion again.

4 Heating



Note:

Thermostatically controlled seat cushion and backrest heating.

5 Lowering



Note:

Lower the seat by pressing the rocker switch down. Move the seat to the adjusted height by pressing the rocker switch up.

6 Damper adjustment



Note:

Handle up = minimum damping. Handle down = maximum damping.

7 Height adjustment



Note:

Pull or press the handle and adjust the seat to the desired height.

8 Lumbar support



Note:

Press the button to charge and discharge each air chamber

9 Swivel release mechanism

10 Backrest adjustment



Note:

Pull the handle up and move the backrest to the desired position.

11 Shoulder adjustment



Note:

Pull the handle up and move the upper half of the backrest to the desired position.

12 Armrest

Operation of the jump seat



Note:

The armrest can be adjusted to any angle using the knurled knob.

Operation of the jump seat



Note:

Only accompanying staff should sit on the jump seat.

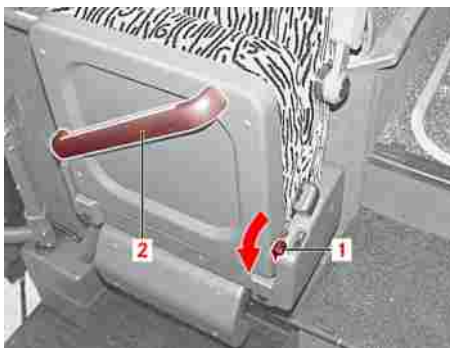

M91_00-0009-01

- ▶ Folding out the jump seat: move stop lever (1) in the direction of the arrow and fold down the seat cushion using grab handle (2).

The jump seat cannot be stopped in the horizontal position. You must hold down the seat cushion until you are seated.



Danger.

If you stand up, the seat cushion will automatically return to its original position. Fold the jump seat down again as described above if you wish to sit down again on this seat.

Adjusting a passenger seat

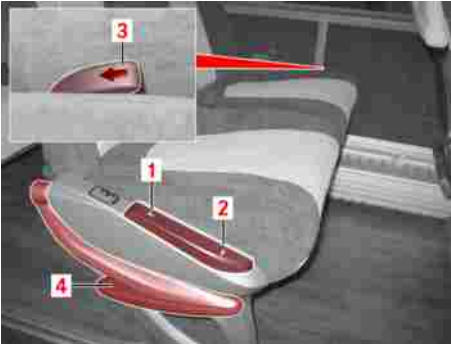

M91.00-0046-71

- ▶ Adjusting the backrest (aisle side):

i **Note:**

Press the rear section of rocker (1) and, at the same time, push back on the backrest with your upper body. Release the rocker when the backrest is at the desired position. The backrest locks in place immediately.

i **Note:**

There are several backrest positions between the vertical normal position and the tilted limit position. You can choose any of these positions.

- ▶ Adjusting the backrest (window side):

i **Note:**

Pull back small black lever (3) between the seat cushion and vehicle wall. At the same time, push back on the backrest with your upper body. Release lever (3) when the backrest is at the desired position.

i **Note:**

There are several backrest positions between the vertical normal position and the tilted limit position. You can choose any of these positions.

- ▶ Sideways adjustment of aisle-side seats

i **Note:**

Press forward section of rocker (2) and, at the same time, move the seat towards or away from the centre aisle.

- ▶ Folding the armrest up or down

i **Note:**

Aisle side: Grasp the front of the raised armrest and lift it slightly. Then carefully fold the armrest down. To fold the armrest up, simply pull it upwards. The armrest engages in its limit position automatically.

i **Note:**

Window side: The armrest for the window seat (option) is located between the seats. It simply folds up and down.

Using the driver's seat belt

Using the driver's seat belt



Note:

The driver's seat that was fitted during production has an integrated belt system. Consequently, the user information and instructions apply only to the factory-fitted belts.



Note:

In Germany, the seat belt must remain fastened at all times while the vehicle is in motion (Section 21a of the German road traffic regulations (StVO)). The rules and regulations of the country in which the vehicle is operated must be observed.

- ▶ Fastening the seat belt: pass the seat belt untwisted and tightly across your pelvis and shoulder and insert it into the belt buckle until you hear it engage.



Danger.

The seat belt must not pass over your neck, be snagged or rub against sharp edges. It should fit as close to the body as possible. You should therefore avoid wearing bulky clothing. Do not route the seat belt over solid or fragile objects in pockets in your clothing. Frequently retighten the seat belt over your shoulder.

- ▶ Releasing the seat belt: press the red button in the buckle and assist the inertia reel by guiding the seat belt back.

Operating the jump-seat seat belt

- ▶ Fastening the seat belt: make sure the seat belt is not twisted, position it tightly over your pelvis and lock it so that you can hear it engage in the belt lock.



Danger.

This seat should only be occupied by the official person accompanying the bus.

- ▶ Releasing the seat belt: press the red button in the buckle and assist the inertia reel by guiding the seat belt back.

Passenger-compartment-seating seat belt

- ▶ Fastening the seat belt: make sure the seat belt is not twisted, position it tightly over your pelvis and lock it so that you can hear it engage in the belt buckle.



Note:

A seat belt may only be used to restrain one person at any one time.

Removing a seat squab



M91.00-0047-71

- ▶ To remove the seat squab, grasp the front of the seat squab with both hands and pull upwards. Then pull the squab in the direction of travel and out of the guide and remove it upwards.

Fitting a seat squab

- ▶ Lift the seat squab at the front slightly and slide the rear into the guide as far as the stop. Press the front of the seat squab down until you hear it engage.

Seat belt reminder display

Seat belt reminder display

Seat belt reminder display



M54_00-0978-01

With the ignition switched on and the doors closed, “Fasten seat belts” symbol (1) on the right-hand side at the front of the passenger compartment is displayed for 5 minutes after the bus has pulled away.

Passenger seat service set

Passenger seat service set



- 1 Loudspeaker
- 2 Air vents
- 3 Stop button (stop request)
- 4 Attendant call button (button lights up when pressed)
- 5 Reading lamp
- 6 Reading lamp button

Transmission shift system safety precautions	186
Operating the PSH (pneumatic shift aid) transmission shift system	187
Transmission shift system GO 250-8 (system description)	187
GO 250 - 8 gearshift unit (selector lever) (option)	190
Operation of the GO 250-8 PowerShift transmission shift system (option)	191
Operation of the GO 250-8 PowerShift failsafe mode (option)	203

Transmission shift system safety precautions

Transmission shift system safety precautions



Danger.

If it is necessary to disembark, even for a short time, with the engine still running, you must make sure that the transmission is in position “N” (neutral), the parking brake has been applied and the bus has been secured by chocks. It is permissible to disembark with the engine still running only if no passengers remain in the passenger compartment and the bus has been secured against unauthorised access.



Danger.

The bus is equipped with a creep function. When the service brake is released with the creep function activated, the bus will creep forwards independently with the engine continuing to run at idling speed. If the engine speed drops below approximately 550 rpm due to increased driving resistance and/or you operate the ser-

vice brake at a low engine speed, the electronics will disengage the clutch automatically. This would interrupt the flow of tractive power and the vehicle could begin to roll back, e.g. on an uphill gradient.



Note:

For as long as both the accelerator pedal and the brake pedal remain fully released, the clutch will stay closed and the vehicle will creep at idling speed. This works in the 1st and 2nd gears.



Caution:

The least wearing on the clutch is idle creeping. In stop-start traffic, therefore, the brake pedal should be used as sparingly as possible (under consideration of the road and traffic situation) so that the vehicle always creeps at idling speed. To keep the driving speed as low as possible, it is possible to shift manually into 1st gear. If the speed of the bus is kept low by means of the brake pedal, the clutch will start to slip. This would res-

ult in increased clutch wear. If the brake pedal is depressed rather more forcefully (more than 10% brake pedal travel), the clutch will open so far that it no longer slips.



Note:

In the event of increased loading on the clutch, an alert (grey) will appear on the display screen. If the load persists, a warning alert (yellow) will appear and the creep function will be deactivated automatically. This is designed to rule out an overloading of the clutch by the creep function.

Operating the PSH (pneumatic shift aid) transmission shift system

Operating the PSH (pneumatic shift aid) transmission shift system

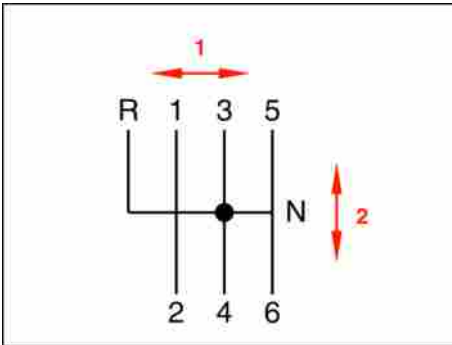

M26_00-0004-01

► Changing gear

**Note:**

This transmission shift system works purely mechanically. At approximately 90 mm, the shift throws are only half as long as those of conventional shift systems. However, the time that is needed for a gear change in the transmission due to synchronisation is nearly the same in physical terms. This means that, to engage the next gear, the driver is now able to move the shift lever handle much

more slowly, i.e. half as fast. Disengagement of a gear is just as fast as normal. The best gearshifts are achieved by moving the gear selector lever with gentle force and “waiting” for the PSH gearshift. Of course, it is possible to change gear faster in difficult situations.

► Changing gear in the event of PSH failure

**Note:**

PSH, the pneumatic shift aid, is designed to make changing gear easier and its pressure is limited to 2.4 bar. If PSH fails, it is still possible to select any of the gears while the bus is in motion, but increased effort will be required. The gearshift duration (shift lever pressed to gear engaged) will be longer because synchronisation will not be as fast.

Transmission shift system GO 250-8 (system description)

The GO 250-8 transmission is adapted to the engine by a dry clutch. As the clutch is controlled automatically by the transmission system, there is no need for a clutch pedal.

Gears are shifted and the clutch is operated electropneumatically. An electronics unit attached to the transmission controls the valves of the pneumatic actuating cylinders at the gear, gate and clutch.

The driver selects the direction of travel using the gearshift unit and is then able to control the forwards and reversing motion of the bus using the accelerator and brake pedal. Advantage: the driver is relieved of having to change gear and use a clutch.

Using the gearshift unit, the driver can choose between automatic and manual gear selection. Manual gear selection should, however, only be used in special cases, e.g. to brake the bus or when driving over mountainous terrain. Auto-

Transmission shift system GO 250-8 (system description)

matic mode should be used for all normal driving conditions.

As the basis for selecting the appropriate gear, the intelligent gear selection function in automatic mode takes into consideration the driver's commands (operation of the accelerator pedal and service brake), the current engine operating state, uphill or downhill gradients and the load on the bus. This achieves the optimum compromise between comfort, fuel economy and wear.

The drive control module coordinates the functions of the drivetrain by informing the engine control module how much engine torque is required and by informing the transmission control module of the gear to be selected and the clutch position to be adopted.

The mechatronic transmission and engine control units then implement the control commands of the drive control for the engine and transmission.

The screen in the instrument panel shows all necessary system information

(e.g. gear, malfunction, etc.) to the driver.

The system has a failsafe mode that can be activated in the event of a fault in the transmission shift system. In this mode, it is possible to drive the bus away from areas of danger or to the nearest workshop. Even if no faults are present, it is possible to activate failsafe mode for training purposes as preparation for this situation.

▷ Refer to “Operation of GO 250-8 failsafe mode” in this section.

Transmission shift systems

GO 250 - 8 gearshift unit (selector lever) (option)

GO 250 - 8 gearshift unit (selector lever) (option)

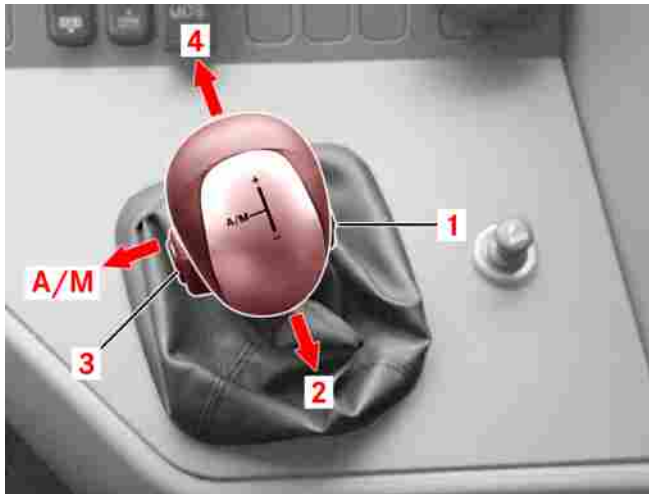

Operation of the GO 250-8 PowerShift transmission shift system (option)

- 1 Neutral button
 2 To shift down/to select reverse gear
 3 Function button
 M/A To switch to manual mode/automatic mode

**Note:**

In automatic mode, pressing briefly toggles between “Basic” and “Dynamic”.

- 4 To shift up

Operation of the GO 250-8 PowerShift transmission shift system (option)

**Danger.**

Never leave the driver's area with the engine running and a gear engaged.

**Danger.**

In the event of a loss of pressure or insufficient supply pressure in the transmission/clutch circuit, it would no longer be possible to shift gear or operate the clutch. Risk of accident. Do not set the vehicle in motion or, if it is already in motion, bring the vehicle to a halt immediately (road and traffic conditions permitting). Secure the vehicle against rolling away, e.g. using the parking brake. Have the compressed-air system inspected immediately and repaired at a qualified specialist workshop. EvoBus recommends an EvoBus Service Partner for this work. It is essential that work relevant to safety or work on safety-related systems be carried out at a qualified specialist workshop.

**Danger.**

The PowerShift transmission shift system automatically disengages the clutch if the engine speed drops below 600 rpm in 1st gear. The power flow is interrupted and the bus could roll back, e.g. on uphill gradients, and you could thereby cause an accident. For this reason, never allow the engine speed to drop below 600 rpm in 1st gear.

- ▶ +++ Selecting the operating mode
+++

**Note:**

With the PowerShift transmission shift system, it is possible to drive in one of two operating modes: Manual mode or automatic mode. In manual mode, you are able to determine the shift point and shift direction yourself. In automatic mode, you simply need to shift into the starting gear. The PowerShift transmission shift system then changes gear automatically, depending on the engine speed, accelerator pedal position, load on the engine, operating status of the continuous

Operation of the GO 250-8 PowerShift transmission shift system (option)

brake, load on the bus and gradient of the road.



Note:

In automatic mode, two shift programs are available: “Basic” and “Dynamic”. These can be activated by means of the A/M pushbutton on the selector lever. The “Basic” shift program is optimised for fuel economy and should generally be the program of choice. The “Dynamic” shift program has a positive effect on the accelerative performance of the vehicle by shifting up at higher engine speeds than in the “Basic” shift program. This leads to higher fuel consumption than in “Basic” mode.



M54.00-2278-71

In manual mode (1), “M” appears next to the gear indicator.

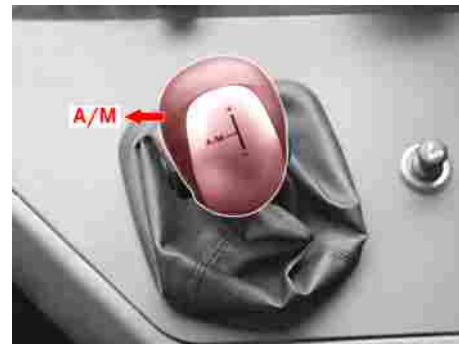

M26_00-0122-71

- ▶ Pressing the selector lever to the left switches from manual mode to automatic mode.

Operation of the GO 250-8 PowerShift transmission shift system (option)



M54.00-2075-71

In automatic mode, “A” appears next to gear indicator (1).

i Note:

For journeys on arduous terrain, it is advisable to select manual mode in order to avoid undesired upshifting, for example, and therefore interruptions in tractive power.

i Note:

To change from “Basic” to “Dynamic” in automatic mode, press the selector lever briefly to the left.



M54.00-2277-71

In “Dynamic” automatic mode, “dyn” (1) appears below the gear indicator.

i Note:

In “Dynamic” mode, upshifts take place at higher engine speeds.

- ▶ +++ Selecting transmission neutral position +++

! Danger.

If you were to select the transmission neutral position while the bus were in motion, you would lose tractive power or the braking effect of the engine. It may not then be possible to bring the bus to a halt in good time and you could thereby cause an accident. For this reason, you should never select the transmission neutral position manually while the bus is in motion.

i Note:

It is possible to select transmission neutral position “N” from any gear provided the selector lever is in the basic position.

Operation of the GO 250-8 PowerShift transmission shift system (option)

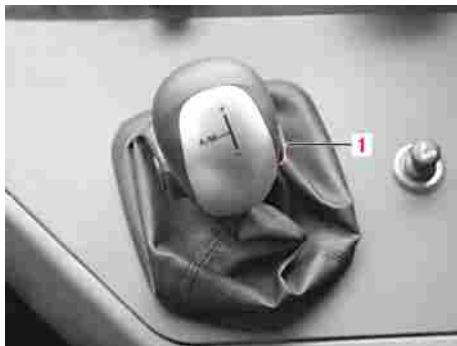

M26_00-0123-71

- ▶ Press neutral button (1).



M54.00-2074-71

“N” appears in gear indicator (1) as soon as the transmission neutral position is selected.



Note:

If the bus is coasting in transmission neutral position “N”, move the gear lever forwards or back. The PowerShift transmission shift system engages the optimum gear.

- ▶ +++ Selecting reverse gear +++
- ▶ Stop the bus.
- ▶ Apply the service brake or parking brake.

Operation of the GO 250-8 PowerShift transmission shift system (option)

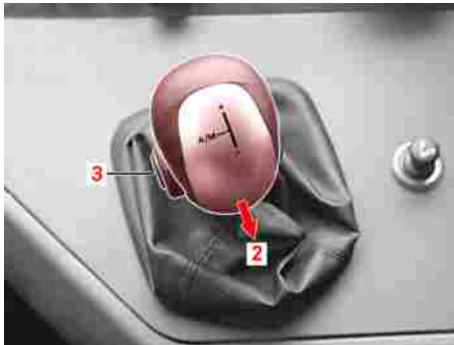

M26_00-0124-71

- ▶ Press and hold function button (3) and pull the selector lever back (2) until resistance can be felt.



Note:

Reverse gear can be selected from transmission neutral position only.

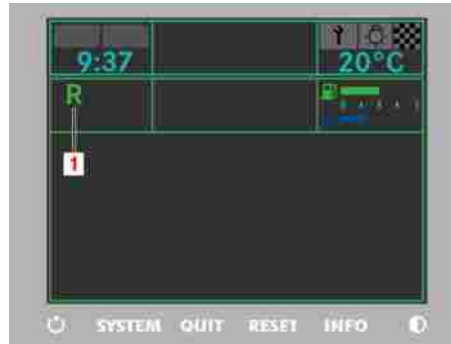

M54.00-2077-71

- “R” appears in gear indicator (1) as soon as reverse gear is selected.



M26_00-0023-01

- ▶ Depress the accelerator pedal slowly and simultaneously release the parking brake.



Danger.

The bus may roll away if you do not depress accelerator pedal (5).

Operation of the GO 250-8 PowerShift transmission shift system (option)



Danger.

There is no engine braking effect if the bus starts to move without a gear having been selected. Do not allow the bus to roll against the direction of travel of the gear that is currently engaged.

The bus starts to move (clutch closes automatically)

- ▶ +++ Change of direction +++



Danger.

The direction of travel cannot be changed unless the bus is stationary, otherwise the transmission will automatically shift into neutral. All changes of direction must take place via neutral. Only the screen display provides a reliable indication of which direction of travel is selected inside the transmission.

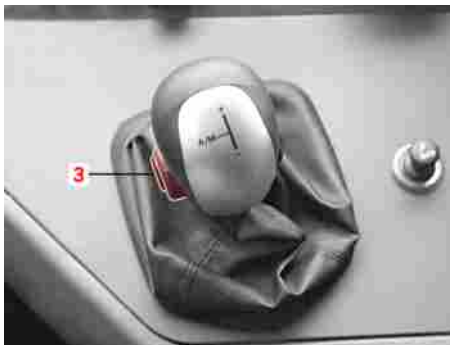

M26_00-0125-71

- ▶ +++ Pulling away +++



Note:

Press function button (3).

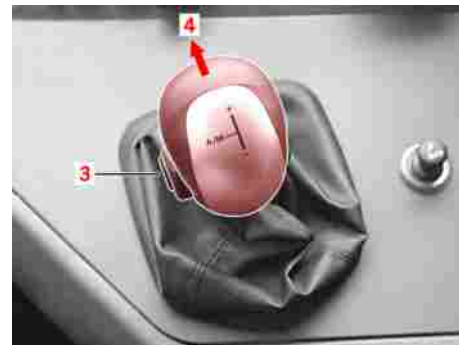

M26_00-0126-71

- ▶ Keep function button (3) pressed and move the gear lever forwards (4).



Note:

The starting gear can be selected from transmission neutral position only.

The PowerShift transmission shift system selects 2nd gear (starting gear).

Operation of the GO 250-8 PowerShift transmission shift system (option)

**Note:**

If the transmission detects an uphill gradient, 1st gear is selected as the starting gear automatically.

**Danger.**

The bus is equipped with a creep function. When the service brake is released with the creep function activated, the bus will creep forwards independently with the engine continuing to run at idling speed. If the engine speed drops below approximately 550 rpm due to increased driving resistance and/or you operate the service brake at a low engine speed, the electronics will disengage the clutch automatically. This would interrupt the flow of tractive power and the vehicle could begin to roll back, e.g. on an uphill gradient.

**Caution:**

The least wearing on the clutch is idle creeping. In stop-start traffic, therefore, the brake pedal should be used as sparingly as possible (under consideration of the road and traffic situation) so that the vehicle always creeps at idling speed. To keep the driving speed as low as possible, it is possible to shift manually into 1st gear. If the speed of the bus is kept low by means of the brake pedal, the clutch will start to slip. This would result in increased clutch wear. If the brake pedal is depressed rather more forcefully (more than 10% brake pedal travel), the clutch will open so far that it no longer slips.

**Note:**

For as long as both the accelerator pedal and the brake pedal remain fully released, the clutch will stay closed and the vehicle will creep at idling speed. This works in the 1st and 2nd gears.

**Note:**

In the event of increased loading on the clutch, a yellow alert warning will appear on the display screen and the creep function will be deactivated automatically. This is designed to rule out an overloading of the clutch by the creep function.



M26_00-0023-01

- ▶ Depress the accelerator pedal slowly and simultaneously release the parking brake.

Operation of the GO 250-8 PowerShift transmission shift system (option)



Danger.

The bus may roll away if you do not depress accelerator pedal (5).



Danger.

There is no engine braking effect if the bus starts to move without a gear having been selected. Do not allow the bus to roll against the direction of travel of the gear that is currently engaged.

The bus starts to move (clutch closes automatically)



Note:

Change the starting gear if 1st gear selected by the PowerShift transmission shift system appears to be an unsuitable gear in which to pull away.

- ▶ +++ Changing the starting gear +++



Note:

2nd gear is the highest gear that can be selected as the starting gear.

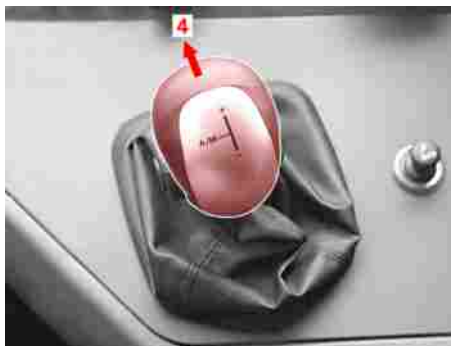

M26_00-0127-71

- ▶ To shift up a gear from the gear selected, move the selector lever forwards (4) until resistance can be felt.
- ▶ To shift down a gear, pull the selector lever backwards until resistance can be felt.



M26_00-0023-01

- ▶ +++ Hill starts +++



Danger.

A gear must be engaged before you attempt to pull away on an uphill gradient. Then depress accelerator pedal (5). Do not release parking brake (4) until you can feel the torque in the drive train. There would otherwise be a risk of the bus rolling backwards.

Operation of the GO 250-8 PowerShift transmission shift system (option)

▶ +++ Accelerating +++

 **Note:**

Whenever the maximum engine speed for the current driving situation is reached in the gear selected, the PowerShift transmission shift system shifts up to the next optimum gear (in automatic drive mode).

 **Note:**

In automatic mode, you can use the accelerator pedal position to actively influence the shift point. Little throttle = early upshift/more throttle = late upshift.

 **Note:**

In “Basic mode”, the engine does not reach the maximum rpm in each gear. Where increased power is required, it will be necessary to activate “Dynamic mode” or use the kickdown function.

▶ +++ Kickdown (automatic drive mode) +++

 **Note:**

Kickdown is used to achieve maximum bus acceleration.

▶ Depress the accelerator pedal beyond the pressure point as far as the stop.

 **Note:**

The PowerShift transmission shift system will shift down into a lower gear if necessary.

▶ Ease off the accelerator pedal once the desired speed has been reached.

 **Note:**

The PowerShift transmission shift system shifts back up.

▶ +++ Decelerating +++

- ▶ Release the accelerator pedal.
- ▶ Slowly depress the brake pedal and/or activate the continuous brake.

 **Note:**

The PowerShift transmission shift system will shift down into a lower gear if necessary (in automatic drive mode).

▶ +++Gearshifts in automatic drive mode+++

 **Note:**

All upshifts and downshifts are carried out automatically. These take place in response to the driving situation, engine load, accelerator pedal position, road speed and engine speed.

Operation of the GO 250-8 PowerShift transmission shift system (option)



Caution:

In overrun mode, the PowerShift transmission shift system shifts up shortly before the engine limit speed is reached. A yellow alert appears on the display screen with the text: “Bremse betätigen” (Apply the brake). A warning tone sounds if the engine limit speed is exceeded.

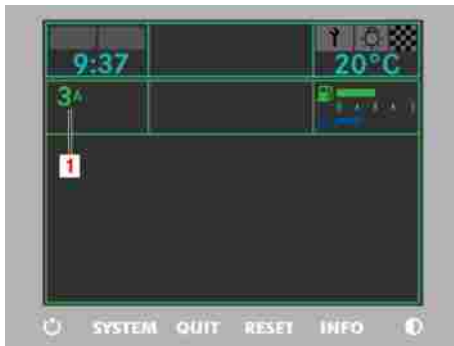

M54.00-2075-71

Screen display in automatic drive mode (gear indicator 1-8 with “A”).

- ▶ +++ Gearshifts in manual mode +++



Note:

In either operating mode (manual/automatic), it is possible to intervene manually to override the gear selected by the PowerShift transmission shift system.

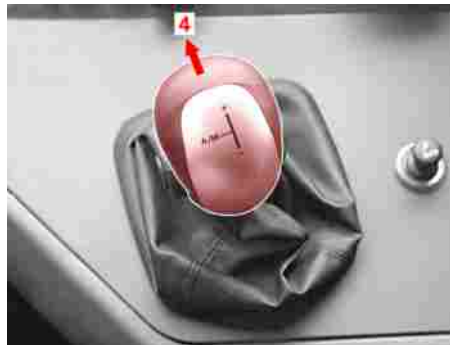

M26_00-0127-71

- ▶ To shift up, move the selector lever forwards (4) until resistance can be felt.

The PowerShift transmission shift system shifts up a gear.



M54.00-2279-71

If an up arrow appears below the “M” in manual mode (1), the engine is operating in an unfavourable speed range. This is a recommendation to shift up a gear.

- ▶ Move the selector lever forwards 2 times (4).

The PowerShift transmission shift system shifts up 2 gears.

Operation of the GO 250-8 PowerShift transmission shift system (option)

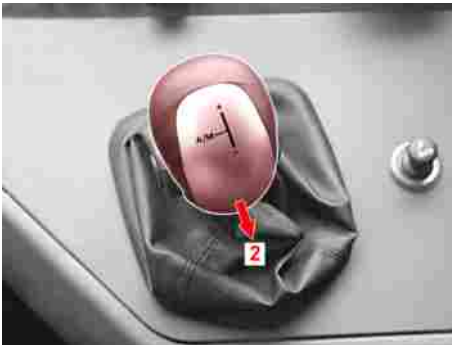

M26_00-0128-71

- ▶ To shift down, pull the selector lever back (2) until resistance can be felt. The PowerShift transmission shift system shifts down a gear.



M54.00-2280-71

- If a down arrow appears below the “M” in manual mode (1), the engine is operating in an unfavourable speed range. This is a recommendation to shift down a gear.
- ▶ Pull the selector lever back two times (2). The PowerShift transmission shift system shifts down 2 gears.



Caution:

If the target gear is too low, the PowerShift transmission shift system shifts down only to a permissible gear that would not cause the engine to overrev.

- ▶ Engine braking effect during a gear-shift



Note:

The braking effect of the engine is temporarily interrupted for the duration of a gearshift (drive train disconnected by the transmission system). Once the shift has been completed, the engine braking effect is automatically restored.



Note:

In automatic drive mode, operation of the continuous brake causes the system to shift down so that maximum engine braking effect is achieved. The extent of the downshift depends on the continuous braking demand and the coolant temperature.

Operation of the GO 250-8 PowerShift transmission shift system (option)



Danger.

The engine braking effect is interrupted for the duration of the gearshift. The bus may accelerate if you are driving downhill at this time.

- ▶ +++ Stopping +++



Danger.

The PowerShift transmission shift system automatically disengages the clutch if the engine speed drops below 600 rpm in 1st gear. Tractive power would be lost and the bus could roll away if the engine is still running and a gear is still selected (e.g. on uphill gradients). You could thereby cause an accident. Whenever you stop the bus, always secure the bus against rolling away using the service brake or the parking brake.

- ▶ Apply the brakes.

- ▶ Shift down if necessary.

The PowerShift transmission shift system disengages the clutch shortly before engine idling speed has been reached.



Note:

The PowerShift transmission shift system engages the starting gear (1st or 2nd gear) whenever the bus comes to a halt.



Caution:

Do not leave the driver's area with a gear engaged and the parking brake applied. This state is not permitted and over time results in damage to the transmission. Always select the transmission neutral position first.

- ▶ +++ Parking the bus +++



Danger.

It is not possible to park the bus with a gear engaged. The PowerShift transmission shift system always selects transmission neutral position "N" when the engine is switched off. If you do not secure the stationary bus using the parking brake, the bus could roll away and you could cause an accident. For this reason, always secure the bus using the parking brake.



Note:

If the bus is parked and the engine is left running, the transmission will shift into neutral automatically after 5 minutes. After 4 minutes, the "N" gear indicator will start to flash. The indicator continues to flash until the starting gear is engaged.

- ▶ Stop the bus.
- ▶ Apply the parking brake.

Operation of the GO 250-8 PowerShift failsafe mode (option)

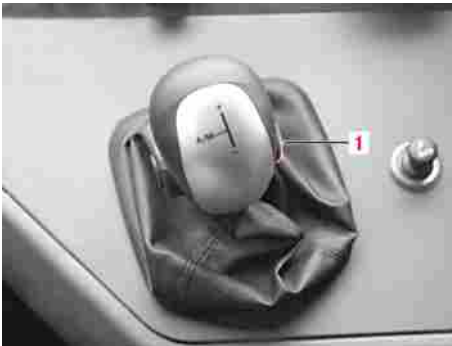

M26_00-0123-71

- ▶ Press neutral button (1).

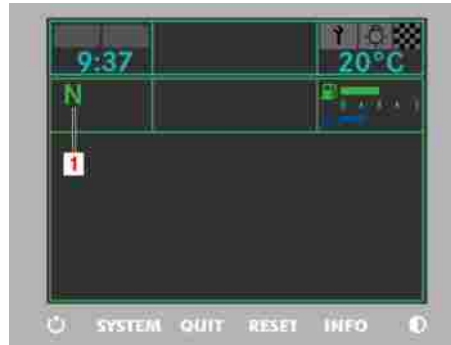

M54.00-2074-71

- “N” appears in gear indicator (1) as soon as the transmission neutral position is selected.
- ▶ Switch off the engine.

Operation of the GO 250-8 PowerShift failsafe mode (option)



Danger.

Never leave the driver's area with the engine running and a gear engaged.



Note:

Under specific circumstances, the engine could stall, particularly if the bus is brought to a halt under heavy braking.



Note:

A malfunction in the system is indicated on the instrument cluster display screen in conjunction with a red or yellow warning level malfunction display. In the event of a yellow alert, the vehicle can continue to be driven in a failsafe mode to the nearest OMNIplus Service Partner.

Operation of the GO 250-8 PowerShift failsafe mode (option)



Note:

It is possible to activate failsafe mode for training purposes even if there is no transmission fault present.

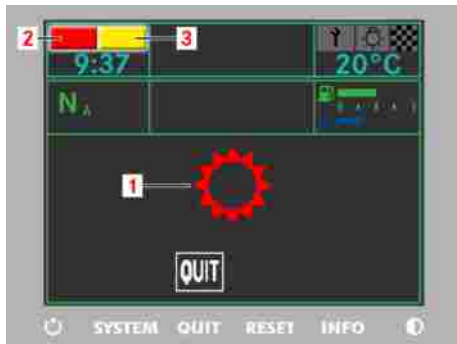

M54.00-2282-71

- ▶ A malfunction in the system is indicated by an icon (1) appearing in the centre of the display screen in conjunction with a red warning level (2) or yellow warning level (3) malfunction display. In the event of a red warning level, an audible warning also sounds.



Danger.

The bus must be stopped immediately (traffic conditions permitting) if a red warning level malfunction is displayed.

- ▶ Bring the bus to a halt and apply the parking brake.



M26_00-0052-71

- ▶ Press the upper section of switch (2) to activate failsafe mode.



Note:

A yellow warning level malfunction display appears when switch (2) is pressed if failsafe mode cannot be activated (exclamation mark not present in the gear indicator on the display screen). Have the malfunction rectified by an OMNIplus Service Partner.



Note:

Neither operating mode (automatic/manual) is displayed in failsafe mode.

Operation of the GO 250-8 PowerShift failsafe mode (option)



M54.00-2281-71

Symbol (3) is now highlighted.
Failsafe mode has been activated.

i Note:

The yellow warning level malfunction display is automatically cleared after a short time.

i Note:

The type of malfunction display depends on the fault.

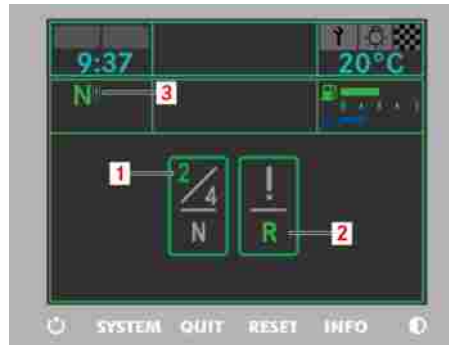

M54.00-2080-71

The two switches on the instrument panel for controlling the failsafe mode are now shown as symbols on the display screen.

i Note:

The selectable gears, 2nd gear (1) or reverse gear (2), are displayed. It is possible to select the transmission neutral position at any time.

i Note:

Failsafe mode can be activated only with the bus stationary and with the parking brake engaged. It is operated by means of the two pushbuttons shown. When failsafe mode is activated, the transmission shifts to neutral even if a gear was previously engaged (unless a severe fault is present). In failsafe mode, it is possible to engage gears as follows: - Upshift from neutral into the slow forward gear D1 (2nd gear possible only when stationary) - Upshift from 2nd gear into the fast forward gear D2 (4th gear possible only when stationary) - Shift from neutral into reverse gear (reverse gear possible only when stationary).

Operation of the GO 250-8 PowerShift failsafe mode (option)



Note:

The yellow warning level malfunction display remains lit.



Note:

The requested gear in failsafe mode is shown to flash until the driver operates the accelerator pedal within the next 10 seconds. If the accelerator pedal is not operated, no gear change will take place.



M68_00-0125-01

- ▶ It is possible to change to the basic screen at any time by pressing the lower section of screen control push-button (1). Failsafe mode remains active in the background.

Driving systems	208
Automatic speed limiter	209
Automatic speed limiter (function description)	209
Variable speed limiter (TempoSet)	210
Activating the variable speed limiter (TempoSet)	211
Combined drive/brake cruise control (option)	213
Activating combined drive/brake cruise control (option)	214

Driving systems

Driving systems

The bus may be equipped with the following driving systems:

- Automatic speed limiter
- Variable speed limiter (Temposet)
- Combined cruise control (drive/brake cruise control)



Danger.

The driving systems listed are only an aid to assist the driver, e.g. to drive at a preselected road speed. The driver is responsible at all times for the actual speed of the bus and for maintaining an adequate distance from the vehicle in front.



Caution:

In the case of buses with manual transmission, the driver must be prepared to change gear in order to regulate engine speed whenever the bus is being accelerated or decelerated by cruise control.

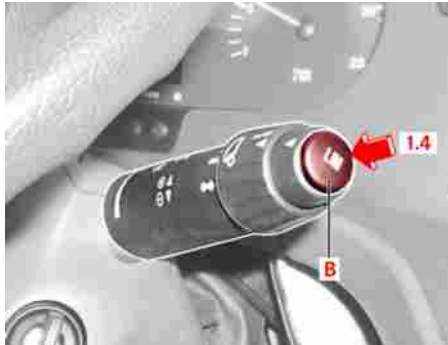

M54_00-1002-01

It is possible to switch between the variable speed limiter (Temposet) and drive/brake cruise control driving systems at any time while the bus is in motion. The symbol for the selected driving system is shown on the display screen.



Note:

Press button (B) to switch between combined drive/brake cruise control and the variable speed limiter (Temposet).

▷ For further notes on operation, refer to “Combination switch for retarder and

cruise control” in the “Driver's area controls” section.

Automatic speed limiter

Since 01.01.2005, all our buses in the EU have been limited to a legally specified maximum speed of 100 km/h.

On steep downhill gradients, this speed may be exceeded for various reasons if the driver does not actively brake the bus.

In these cases, the speed limiter would stabilise the speed of the bus automatically using the continuous brake (retarder).



Note:

The maximum limit speed corresponds to the value set in the speed limiter and not to the speed controls in force in other countries (i.e. a fixed value that cannot be changed, e.g. during long-distance travel from one country to another).

Automatic speed limiter (function description)

Functions:

- Speed limiter active
- Speed limiter warning message

Speed limiter active



M54.00-2081-71

The automatic speed limiter constantly monitors the maximum speed for the vehicle. If 100 km/h is reached in overrun mode, the engine torque is reduced first. If a speed of 104 km/h is reached despite this measure, the retarder is ac-

tivated and this symbol (1) appears on the display screen.

Speed limiter warning message



M54.00-2082-71

This warning message appears on the instrument cluster display screen together with a yellow warning level malfunction if a speed of 107 km/h is reached despite use of the retarder or if retarder braking performance is reduced (due to high coolant temperatures). A warning tone also sounds.

Variable speed limiter (TempoSet)



Danger.

To avoid the risk of endangering passengers and other road users, it will be necessary to brake the bus using the service brake.



Note:

The menu that was displayed at the time of the warning returns to the display screen as soon as the speed of the bus drops back below the defined maximum speed.

Variable speed limiter (TempoSet)

Using the speed limiter, it is possible to set any speed above 15 km/h as a limit speed. It is possible to accelerate the bus up to the speed set using the accelerator pedal.



Danger.

The speed limiter limits the set speed automatically. The speed limiter is unable to interpret road and traffic conditions itself.



Note:

The retarder is automatically activated if the set limit speed is exceeded by more than 4 km/h in overrun mode.



Danger.

The speed limiter is only an aid designed to assist driving. You are responsible at all times for the speed of the bus and for maintaining an adequate distance to the vehicle in front. Do not use the speed limiter unless traffic conditions permit a constant speed to be maintained.

Activating the variable speed limiter (TempoSet)

Activating the variable speed limiter (TempoSet)

i **Note:**

It is possible to exceed the stored limit speed, e.g. when overtaking. To do this, depress the accelerator pedal briefly beyond the full-throttle position as far as the stop. As soon as the overtaking manoeuvre is over, release the accelerator pedal briefly and depress it again. This will reactivate the set limit speed.

i **Note:**

If the bus is travelling faster than the stored limit speed at this time, the bus will be decelerated automatically by the retarder.



M54.00-2083-71

- ▶ Press function toggle button (B) repeatedly until LIM appears on the display screen

i **Note:**

The variable speed limiter (TempoSet) is now selected.

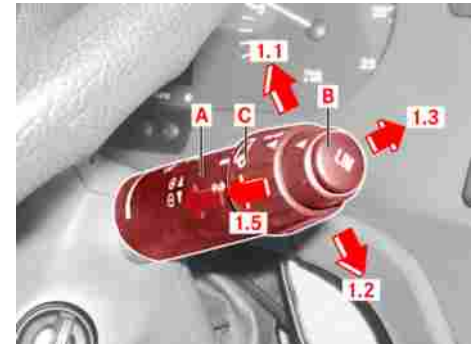

M54_00-0993-01

- ▶ Move steering column switch (A) to position (1.1).

i **Note:**

The variable speed limiter (TempoSet) is now activated.

- ▶ Use the accelerator pedal to accelerate the bus up to the desired speed.
- ▶ Briefly move steering column switch (A) to position (1.1).

Activating the variable speed limiter (TempoSet)



M54.00-2083-71

The "LIM" icon and the stored maximum speed are shown on the display screen whenever the variable speed limiter (TempoSet) is active.

i **Note:**

Briefly pressing the steering column switch to position (1.1) or position (1.2) now increases or reduces the stored limit speed in increments of 0.5 km/h respectively.

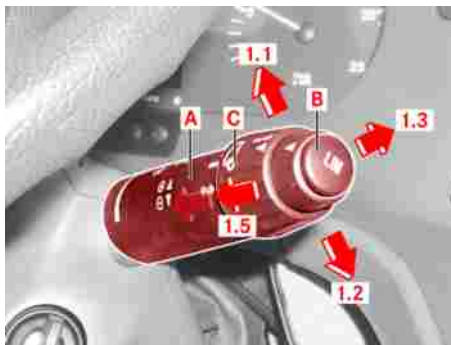

M54_00-0993-01

- ▶ Hold steering column switch (A) in position (1.1) for some time.

i **Note:**

The maximum speed is increased in increments of 0.5 km/h.

- ▶ Hold steering column switch (A) in position (1.2) for some time.

i **Note:**

The maximum speed is reduced in increments of 5 km/h.

- ▶ Release the steering column switch.

i **Note:**

The selected limit speed is stored.

Combined drive/brake cruise control (option)

Combined drive/brake cruise control (option)

Combined drive/brake cruise control is able to control both the engine and the retarder. The system maintains a stored cruising speed provided there is sufficient engine power output or retarder braking output available (with a tolerance of +2.5 mph (+4 km/h) on downhill gradients). On level surfaces and on uphill gradients, the speed is regulated by the engine (drive cruise control). On downhill gradients, the speed is regulated by the retarder (brake cruise control). The speed is maintained constant only for as long as the braking performance of the retarder remains sufficient for this to be possible. If necessary, shift down and reduce speed.



Danger.

To maintain the stored speed, combined drive/brake cruise control automatically operates either the engine control in order to accelerate the bus (drive cruise control) or the engine brake and retarder to decelerate the bus (brake cruise control). Combined drive/brake cruise control is unable to interpret road and traffic conditions itself. For this reason, do not activate combined drive/brake cruise control on slippery road surfaces, in fog or in difficult road and traffic conditions. You could fail to recognise dangers in good time, and endanger yourself and others. When driving on a slippery road surface, the wheels could lock and the bus could skid.



Danger.

The cruise control function is only an aid designed to assist driving. The driver is responsible at all times for the speed of the bus and for maintaining an adequate distance to the vehicle in front. Do not use cruise control unless traffic condi-

tions permit a constant speed to be maintained. It may not be possible for a constant speed to be maintained on steep uphill or downhill gradients. Take your foot off the accelerator pedal when cruise control is active.



Note:

The retarder may be activated for additional braking force. The cruise control system will remain active. The service brake may also be applied while the bus is being braked by the retarder. The cruise control system will remain active. If cruise control is braking the bus using the retarder, the retarder will not be deactivated if the service brake is then applied. As soon as the retarder is deactivated, the bus will accelerate to the previously stored speed.

Activating combined drive/brake cruise control (option)

Activating combined drive/brake cruise control (option)



Note:

Precondition: bus speed must be greater than 10 mph (15 km/h). The clutch and service brake pedals must be fully released and the continuous brakes must not be active.



Note:

The speed is maintained constant only for as long as the braking performance of the retarder remains sufficient for this to be possible. If necessary, shift down and reduce speed.



Note:

It is possible to exceed the stored speed, e.g. when overtaking. To do this, depress the accelerator pedal. When the overtaking manoeuvre is over, release the accelerator pedal again. Cruise control will re-adjust the speed of the bus to the stored speed.

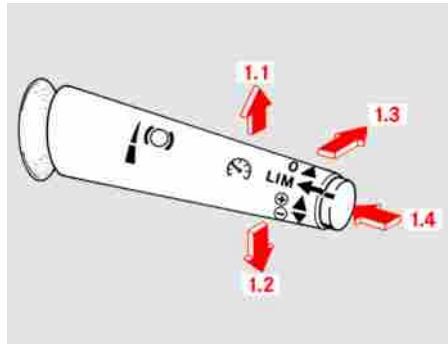

M54_00-1003-01

- ▶ Briefly move the steering column switch to position (1.1) or (1.2) (< 0.5 seconds).



Note:

Moving the steering column switch to position (1.2) enables you to call up a previously stored speed.



M54.00-2084-71

The desired speed set is shown in the display.



Note:

Repeated and brief movement to position (1.1) (< 0.5 seconds) = increase in set speed in 0.5 km/h increments. Repeated and brief movement to position (1.2) (< 0.5 seconds) = reduction in set speed in 0.5 km/h increments.

Activating combined drive/brake cruise control (option)



Note:

Holding the steering column switch (> 0.5 seconds) in position (1.1) accelerates the bus. When the combination switch is released, the current speed is set as the new value.



Note:

Holding the steering column switch (> 0.5 seconds) in position (1.2) decelerates the bus. When the combination switch is released, the current speed is set as the new value.



M54.00-2085-71

After a brief delay, the desired speed set (3) appears on the display screen along with “cruise control” icon (2) (see illustration).

- Move the steering column switch to position (1.3).

The combined drive/brake cruise control is deactivated. Cruise control is deactivated automatically:



Note:

- if the bus is braked using the service brake and cruise control is currently in operation. The speed set remains stored.



Note:

- if the speed drops below 10 mph (15 km/h), a short warning signal will sound. The speed set remains stored.



Note:

- if the clutch pedal is depressed for longer than 5 seconds, e.g. during gear selection. A short warning signal will sound.



Note:

- if the transmission is shifted to the neutral position for longer than 5 seconds. A short warning signal will sound.

Operating instructions for the air-conditioning system 218

Heating/ventilation/air-conditioning (HVAC) control panel 220

Manually regulating the blower speed in the driver's area 223

Preselecting the passenger-compartment temperature 224

Manually regulating the blower speed in the passenger compartment 226

Activating the air-conditioning 227

Activating air-recirculation mode in the driver's area/passenger compartment 228

Activating the reheat function 228

Activating the auxiliary heating unit 229

Programming auxiliary heating switch-on times 231

Activating a programmed auxiliary heating switch-on time 233

Deactivating an activated switch-on time 234

Programming the auxiliary heating switch-on duration 235

Switches/controllers in the driver's rest area 236

Operating instructions for the air-conditioning system

Operating instructions for the air-conditioning system



Note:

For optimum climate control in heating or cooling mode, the driver's window should remain closed while the vehicle is in motion.



Note:

The openings below the spare wheel in the compartment must not be sealed or covered by objects as troublefree operation of the heating, ventilation and air-conditioning system would no longer be guaranteed.

Heating/ventilation/air-conditioning (HVAC) control panel

Heating/ventilation/air-conditioning (HVAC) control panel

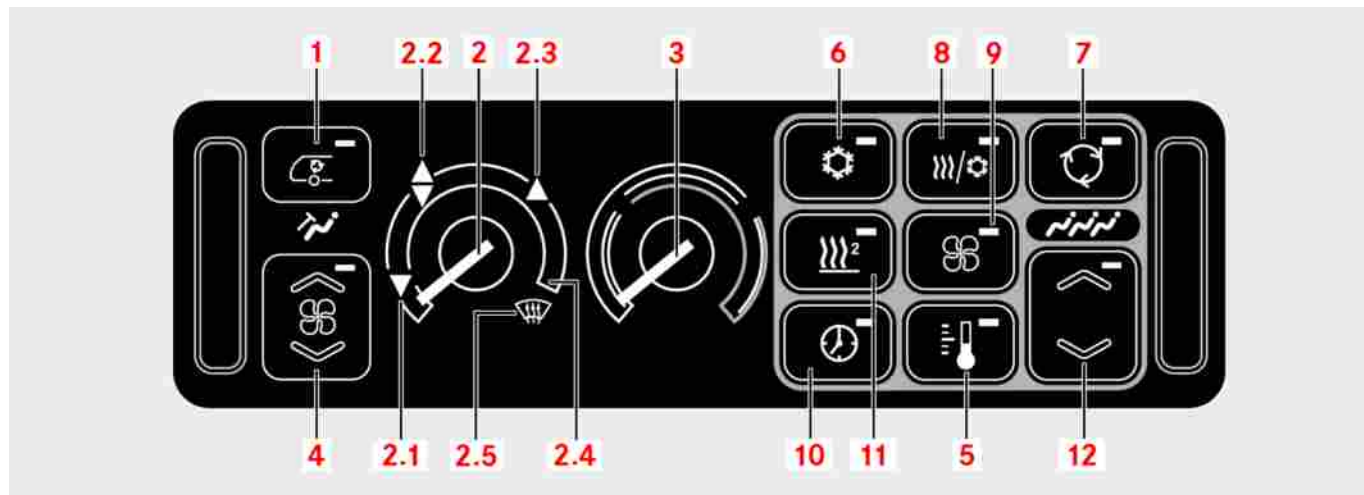

Heating/ventilation/air-conditioning (HVAC) control panel



Note:

Switch the ignition starter switch to ON before you switch on the heating and ventilation control system. The driver's area air-conditioning cannot be operated separately from the passenger compartment air-conditioning.

- 1 Button for air-recirculation/fresh-air mode in the driver's area



Note:

(Integrated LED lit in air-recirculation mode - LED unlit in fresh-air mode)

- 2 Rotary knob for air distribution in the driver's area: Infinitely variable



Note:

Air permanently flows out of the swivelling air vents in the instrument panel (driver's station) and in the forward structure (co-driver's seat) regardless of the position of the rotary knob. The airflow can be regulated manually as desired using the adjustment slide on the air vent itself.

- 2.1 Air distribution to the footwell
- 2.2 Air distribution to the footwell and windscreen
- 2.3 Air distribution to the windscreen
- 2.4 Fresh-air vent in the instrument panel
- 2.5 Defrosting the windscreen (blower automatically set to fastest speed)
- 3 Rotary knob for temperature control in the driver's area

- 4 Rocker switch for blower speed control in the driver's area
- 5 Button for temperature control in the passenger compartment



Note:

Pressing the button for longer than 2 seconds automatically selects the optimum temperature. (LED in pushbutton (5) unlit)

- 6 Automatic A/C mode "ON/OFF" button



Note:

(LED lit in automatic A/C mode)

Heating/ventilation/air-conditioning (HVAC) control panel

- 7 Smog button for the driver's area and passenger compartment (use, for instance, when driving through a tunnel): Passenger-compartment and driver's area ventilation switches to air-recirculation mode. The roof hatches are closed automatically.



Note:

The LED integrated in the button lights up.

- 8 Reheat button (use to dehumidify the vehicle interior): The air-conditioning system is switched to heating control. The recirculated air (i.e. the reduced amount of fresh air) is cooled as it comes into contact with the refrigerant heat exchanger and reheated by the heat exchanger for the heating system. This process condenses water out of the air passed through the system. The air directed to passengers or the driver is thereby dehumidified.



Note:

The LED integrated in the button lights up

- 9 Manual blower speed adjustment button
- 10 Preset timer button:



Note:

refer to "Programming the preset timer"



Danger.

Observe the safety precautions for operation of the auxiliary heating unit in the Operating Instructions.

- 11 Auxiliary heater "ON/OFF" button: The integrated LED indicates when the auxiliary heating unit is ready for operation (in standby). The auxiliary heating unit switches to a state of readiness only if the outside temperature is at least 6 °C below the setpoint value selected (passenger compartment).

Manually regulating the blower speed in the driver's area



Danger.

Observe the safety precautions for operation of the auxiliary heating unit in the Operating Instructions.

- 12 Rocker switch for adjusting values and functions of push-buttons 5/9/10:

Manually regulating the blower speed in the driver's area

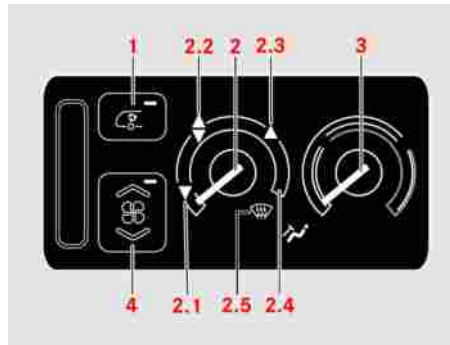

M83_00-0783-71

- Press button (4) on the control panel



Note:

The LED in the pushbutton starts to flash



M54.00-2086-71

This display appears on the instrument cluster display screen



Note:

The blower speed currently set is represented by the bars in the centre section of the instrument cluster display screen.

- Button (4) can now be used to reduce (-) or increase (+) the blower speed.

Preselecting the passenger-compartment temperature



Note:

If button (4) is not pressed again within 10 seconds or if a different button is pressed, the indicator on the display screen is cleared and the LED in the rocker switch stops flashing. The newly entered setpoint value is stored.

Preselecting the passenger-compartment temperature

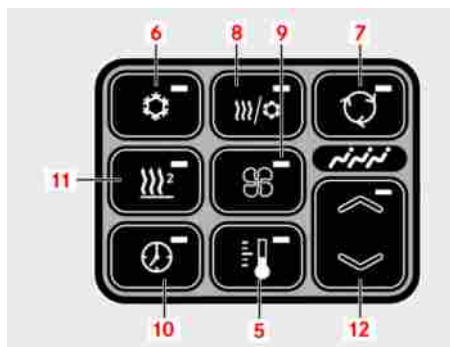

M83.00-0901-71

- ▶ Press button (5) on the control panel. The LED in rocker switch (12) starts to flash

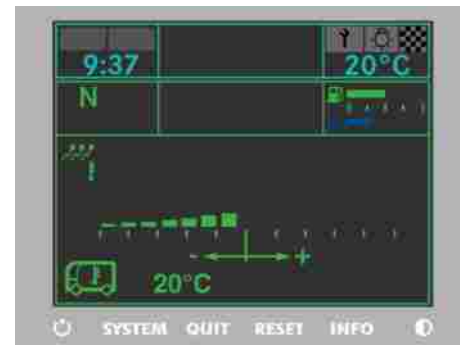

M54.00-2088-71

The setpoint value currently set is represented by the bars in the centre section of the instrument cluster display screen.



Note:

The actual outside temperature (1) and the temperature in the passenger compartment (2) are also displayed on the display screen.

Preselecting the passenger-compartment temperature

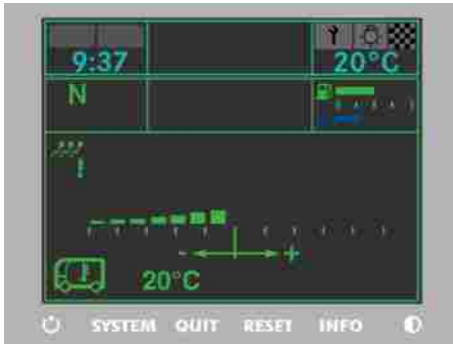

M54.00-2088-71

- ▶ The setpoint value for the passenger compartment can now be changed using rocker switch (12) (+ or -).

i Note:

Pressing button (5) for longer than 2 seconds automatically selects the optimum value. When the optimum value is set (see the marker bars between + and - in the display), the LED in pushbutton (5) remains unlit.

i Note:

The setpoint value can be changed up or down as required with button (12). The setpoint value should only be changed in small increments.

i Note:

If button (12) is not pressed again within 10 seconds or if a different button is pressed, the indicator on the display screen is cleared and the LEDs in the rocker switch stop flashing. The newly entered setpoint value is stored.

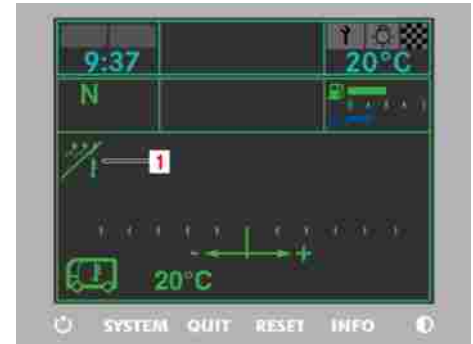

M54.00-2090-71

- If no bars are shown and icon (1) is displayed, this means that automatic A/C regulation in the passenger compartment has been deactivated.

Manually regulating the blower speed in the passenger compartment

Manually regulating the blower speed in the passenger compartment

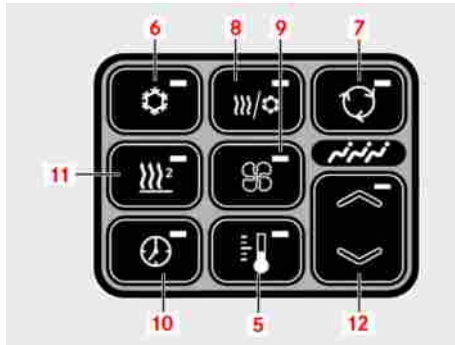

M83.00-0901-71

- ▶ Press button (9) on the control panel

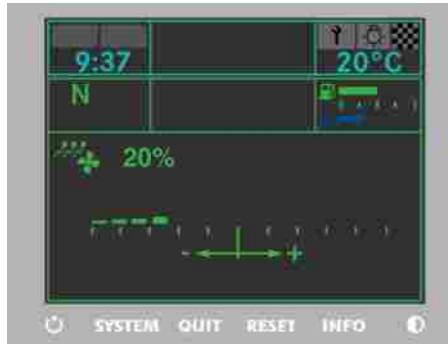

M54.00-2087-71

- Whenever button (9) is pressed, the LEDs in rocker switch (12) begin to flash. The current blower speed is represented by the bars on the instrument cluster display screen.
- ▶ It is now possible to adjust the ceiling blower speed to any value between 20 % and 100 % by pressing rocker switch (12) (+ or -).



Note:

Pressing button (9) for longer than 2 seconds automatically selects the optimum blower speed. At optimum blower speed, the LED in pushbutton (9) remains unlit.



Note:

If button (12) is not pressed again within 10 seconds or if a different button is pressed, the indicator on the display screen is cleared and the LEDs in rocker switch (12) stop flashing. The newly entered setpoint value is stored.

Activating the air-conditioning

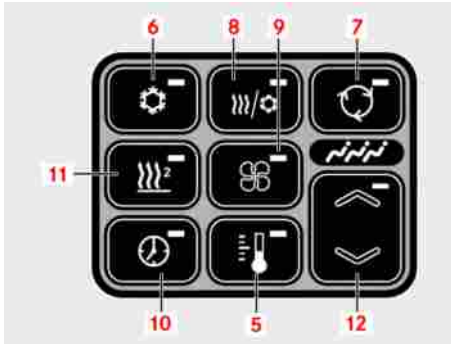

M83.00-0901-71

- Press button (6) on the control panel

Once the LED integrated in button (6) lights up, this indicates that the air-conditioning system is enabled. If this symbol appears on the display screen, the air-conditioning system is active (operating). The roof hatches close automatically whenever the air-conditioning system is activated.

Note:

The air-conditioning system is switched on automatically after a 60 second delay depending on the desired temperature and the outside and interior temperatures. The “Temperature lockout” symbol appears on the display screen if temperature conditions are preventing the air-conditioning system from switching on. If button (6) is pressed in buses that do not have an air-conditioning system, the “Air-conditioning system not available” symbol is shown on the display screen.

Note:

If cooling output is inadequate in air-conditioning mode and no malfunction is indicated on the display screen, you can activate the ventilation program by switching off automatic A/C mode.

Note:

The status in effect at the time the ignition starter switch is switched to OFF is retained when the ignition is switched back on.



If this symbol appears, current temperature conditions are preventing activation of the air-conditioning system.



If this symbol appears when you press button (6), this indicates that the bus does not have an air-conditioning system.

Activating air-recirculation mode in the driver's area/passenger compartment

Activating air-recirculation mode in the driver's area/passenger compartment

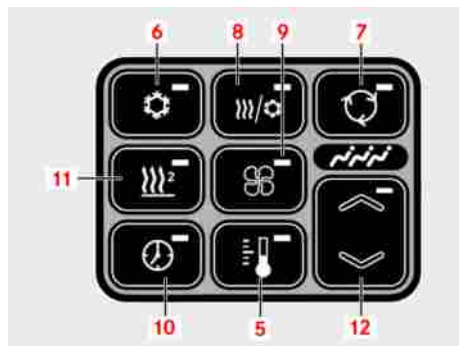

M83.00-0901-71

- ▶ Press button (7) on the control panel.



This symbol appears on the instrument cluster display screen. The LED in button (5) lights up. In addition, the roof hatches close automatically.



Note:

Use this function when driving through a tunnel, for example. “Smog” mode is limited to a period of approximately 10 minutes. It is possible to switch the driver's area back to fresh-air mode separately using switch (1); smog mode remains in effect in the passenger compartment. Switch it off by pressing button (7) (LED off) again.

Activating the reheat function

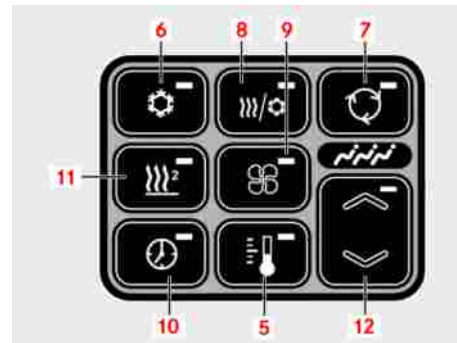

M83.00-0901-71

- ▶ Press button (8) on the control panel.



Note:

The recirculated air (i.e. the reduced amount of fresh air) is cooled as it comes into contact with the refrigerant heat exchanger and reheated by the heat exchanger for the heating system. This process condenses water out of the air passed through the system. The air directed to passengers or the driver is thereby dehumidified.

Activating the auxiliary heating unit

The LED integrated in the pushbutton lights up and the roof hatches close automatically.



Note:

Reheat mode is available only if the outside temperature is above approximately 5 °C. Its operating period is limited to approximately 30 minutes. To switch it off, press the reheat button again (LED off).



If this symbol appears when you press button (8), this indicates that the bus does not have an air-conditioning system.

Activating the auxiliary heating unit



M83.00-0901-71

- Press button (11) on the control panel.



Danger.

Risk of fire and burns. There is a risk of fires and burns due to the high exhaust temperatures and the hot exhaust pipe for the auxiliary heating. For this reason, do not stop or park the bus over ignitable materials (e.g. grass) when the auxiliary heating is in operation, has recently been in operation or has been operated by the instant heating button/preset timer.



This “Temperature lockout” symbol appears on the display screen if current temperature conditions are preventing activation of the air-conditioning system. If button (6) is pressed in buses that do not have an air-conditioning system, the “Air-conditioning system not available” symbol is shown on the display screen.

Activating the auxiliary heating unit



Danger.

Risk of poisoning and asphyxiation. The auxiliary heating must not be used in enclosed spaces such as garages or workshops due to the risk of poisoning and asphyxiation. Timer and preselection mode are similarly prohibited.



Danger.

Risk of fire. The auxiliary heating must remain switched off in places where ignitable vapours or dust can accumulate (e.g. in the vicinity of filling stations, fuel depots, or coal, sawdust or grain stores or similar).



Note:

The integrated LED indicates when the auxiliary heating unit is ready for operation (in standby). The auxiliary heating unit cannot be switched to standby mode unless automatic control has been enabled.



Note:

With the ignition starter switch OFF, it is possible to switch the auxiliary heating unit on directly by pressing button (11) on the control panel. The LED in button (11) lights up and the auxiliary heating is activated. The auxiliary heating unit switches off automatically after 30 minutes or if the button is pressed again; the LED in button (11) goes out.



Whenever the auxiliary heating unit is active (ignition starter switch position ON), this symbol appears on the display screen after a time delay of approximately 20 seconds. The status in effect at the time the ignition starter switch is switched to OFF is retained when the ignition is switched back on.



If this symbol appears on the display screen when button (11) is pressed, this indicates that the bus does not have an auxiliary heating unit.



The “Temperature lockout” symbol appears on the display screen if temperature conditions are preventing the heating system from switching on.

Programming auxiliary heating switch-on times

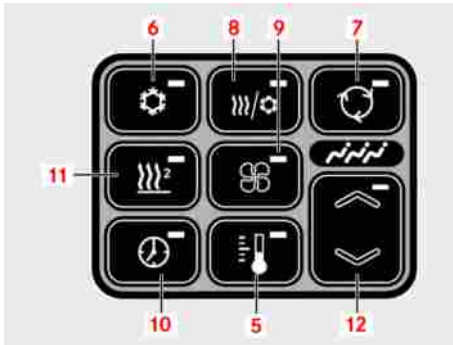

M83.00-0901-71

- Keep button (10) pressed down until the preset timer menu is shown on the display screen.

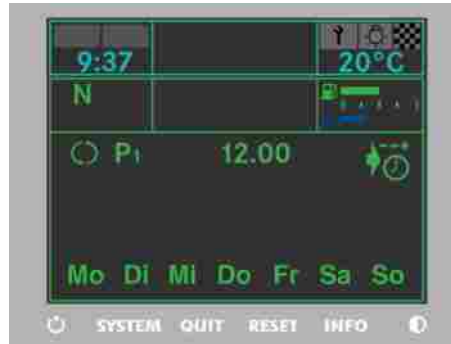

M54.00-2117-71

Screen display in preset timer menu (selection mode).

i Note:

In selection mode, rocker switch (12) can be used to select P1, P2, P3 or the switch-on duration.



Note:

The displayed date and time are imported from the tachograph and can therefore only be corrected there.

- Briefly press button (10) to change to setting mode.



Note:

The switch-on times may only be set or modified in setting mode.

Programming auxiliary heating switch-on times



M54.00-2118-71

- ▶ A bar now appears under the time display (hours). The hours can now be set using rocker switch (12). (If it is not necessary to correct the hours, it is possible to move on to change the minutes by pressing button (10).)

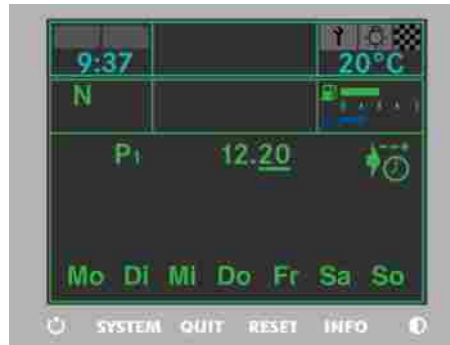

M54.00-2091-71

- ▶ The minutes display can be set with rocker switch (12) when the bar is shown under the minutes. If it is not necessary to correct the minutes, it is possible to move on to change the weekday by pressing button (10).

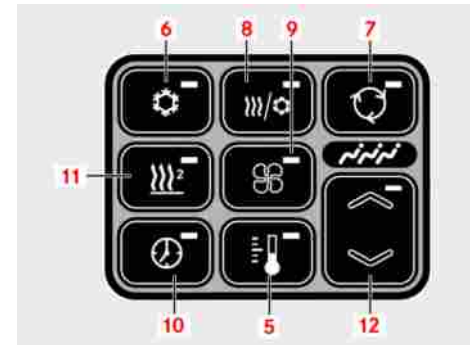

M83.00-0901-71

- ▶ The relevant weekday is selected using button (10) and set or unset using rocker switch (12). (If the weekday is displayed, it has been enabled. Weekdays that are not displayed have not been enabled.)



Note:

The changes are stored when you press button (10) on reaching the last weekday (Sunday). The display reverts to selection mode automatically and it is now possible to select the next program (P1, P2, P3).

Activating a programmed auxiliary heating switch-on time



M54.00-2092-71

Screen display when activating the weekdays.

Activating a programmed auxiliary heating switch-on time

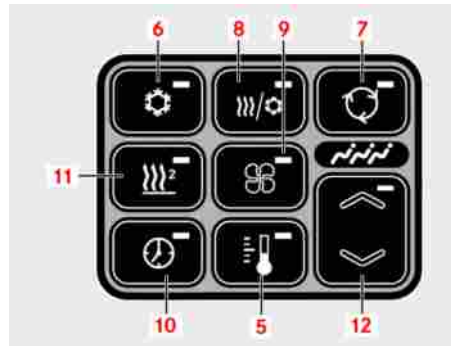

M83.00-0901-71

- ▶ Press button (10) briefly and select the relevant storage position (P1, P2 or P3) with rocker switch (12). Confirm the selection by pressing button (10).



Note:

The LED integrated in button (10) indicates whether a switch-on time has been activated. Steady light for "ignition starter switch ON". Flashing for "ignition starter switch OFF".



Danger.

Risk of fire and burns. There is a risk of fires and burns due to the high exhaust temperatures and the hot exhaust pipe for the auxiliary heating. For this reason, do not stop or park the bus over ignitable materials (e.g. grass) when the auxiliary heating is in operation, has recently been in operation or has been operated by the instant heating button/preset timer.

Deactivating an activated switch-on time



Danger.

Risk of poisoning and asphyxiation. The auxiliary heating must not be used in enclosed spaces such as garages or workshops due to the risk of poisoning and asphyxiation. Timer and preselection mode are similarly prohibited.



Danger.

Risk of fire. The auxiliary heating must remain switched off in places where ignitable vapours or dust can accumulate (e.g. in the vicinity of filling stations, fuel depots, or coal, sawdust or grain stores or similar).



M54.00-2093-71

Screen display when activating the switch-on times.

Deactivating an activated switch-on time

- ▶ Briefly press button (10) and select the OFF menu item with rocker switch (12). Confirm the selection by pressing button (10).



Note:

The LED integrated in button (10) goes out. No deactivation is possible unless the ignition switch is switched on.



Note:

After a program has run its course, it is necessary to activate the next switch-on time. For preselection mode, no more than one switch-on time can be activated.

Programming the auxiliary heating switch-on duration

Programming the auxiliary heating switch-on duration

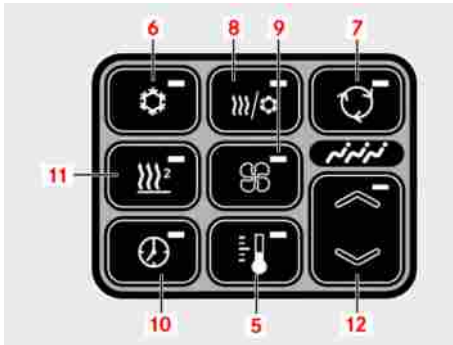

M83.00-0901-71

- ▶ Keep button (10) pressed until the preset timer menu (selection menu) is shown on the display screen.

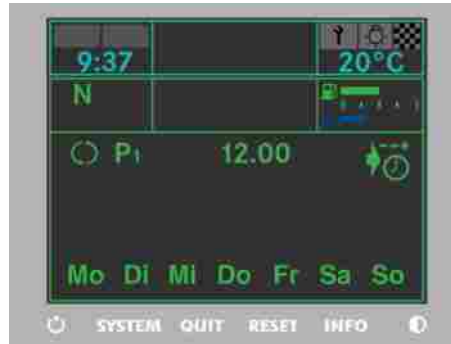

M54.00-2117-71

Screen display in preset timer menu (selection mode).

- ▶ Press rocker switch (12) (+ or -) downwards until the switch-on duration menu is shown on the display screen. Briefly press button (10) to change to setting mode. Rocker switch (12) can now be used to adjust the switch-on duration in the 10-120 minutes range. Confirm the change by pressing button (10).



Note:

The auxiliary heater switch-on duration is programmed once and then applies for all switch-on times (P1, P2, P3).



Note:

Recommended switch-on duration: 30 - 40 minutes. A longer switch-on duration could discharge the vehicle batteries.

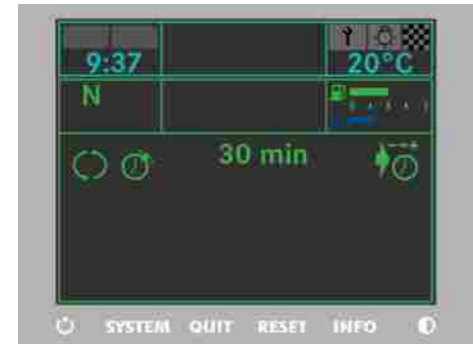

M54.00-2094-71

Screen display when setting the switch-on duration.

Switches/controllers in the driver's rest area

Switches/controllers in the driver's rest area

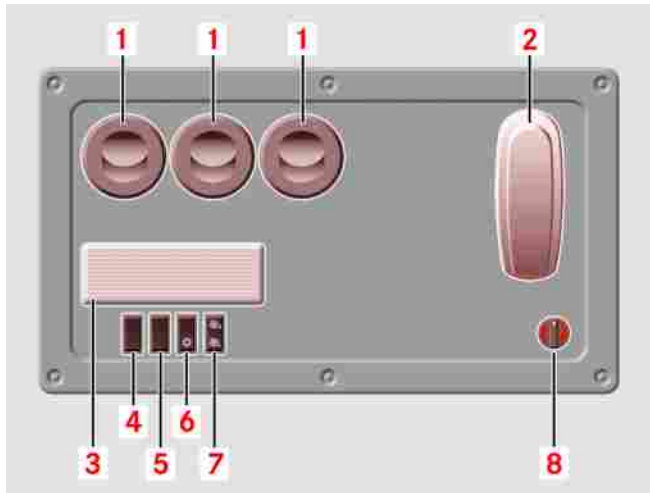

Switch for ventilation blower speed I and II (7)



When the switch is pressed, the blower for ventilating the driver's rest area operates at half speed or full speed, depending on the switch position.



Note:

The air from vents (1) may be hot or cold. This depends on the position of controller (8) and switch position (6).

Heating controller (8)

Manual, infinitely variable adjustment of the outlet temperature.



Note:

Warm: turn the controller clockwise.



Note:

Cold: turn the controller anti-clockwise.



Note:

The engine or the water heater must be running.

Door pushbutton in the driver's area	241
Anti-entrapment protection (reversing) as the doors are closed	242
Protection against entrapment in the door opening direction	242
Locking the exterior emergency valve at door 2 (option)	243
Operating/malfunction displays: doors	243
Unlocking the door circuit at the front right door	245
Unlocking door 2	246
Unlocking the door circuit using the radio remote control (option)	246
Unlocking the luggage compartment flaps using the pushbuttons in the driver's area	247
Unlocking the luggage compartment flaps using the remote control (option)	248
Locking door 2	248
Locking door 1	249
Locking using the radio remote control (option)	250
Central locking system (option) (system description)	251
Operating/malfunction displays: central locking	254
Emergency operation of the doors (depressurising the doors using the emergency valves)	255

Table of contents

Emergency unlocking of the luggage compartment flaps in the event of a compressed-air supply failure	257
Opening/closing the service cover under the driver's window	258
Opening/closing the roof hatches manually	259
Emergency exit through emergency operation of the electric roof hatches (option)	260

Door pushbutton in the driver's area

Door pushbutton in the driver's area

Door pushbutton for front right door (I) and centre right door (II) (10) with integrated warning lamps (locator lighting also ON when Lights ON).

i **Note:**

The warning lamp lights up when: - a door is open - a door is not fully closed (door not in the catches).

i **Note:**

The warning lamp flashes in the following situations: - the emergency switch is activated - the operating pressure is too low (depressurised bus door) - the door is open and the speed of the vehicle is more than 3 km/h - the door malfunctions.

! **Danger.**

The doors do not operate if the display flashes. Do not move the bus if a warning lamp in the door pushbutton lights up or a yellow or red warning is shown on the display screen. Otherwise, a red warning appears on the display screen and the warning buzzer sounds.

i **Note:**

A door cannot be operated unless the ignition is ON, the bus is stationary and the doors have been unlocked.



M72_00-0332-71

Anti-entrapment protection (reversing) as the doors are closed

Anti-entrapment protection (reversing) as the doors are closed

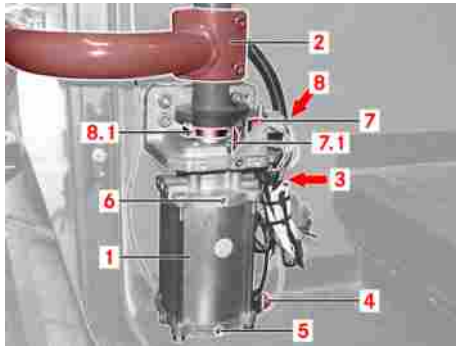

M72_00-0159-01

Reversing switch (7)

The anti-entrapment protection is activated if a person or object blocks the door leaf while the door is closing.

In this event, the door leaf is raised and the cam (7.1) operates the reversing switch (7).

The door valve changes to Open.



Danger.

If the door pushbutton for door 1 (front right) is pressed and held for some time, the reverse movement may be disabled, deactivating the anti-trap function. When the door pushbutton is released, the anti-entrapment protection is reenabled.

Protection against entrapment in the door opening direction

Opening pressure is limited to 4.2 bar when the doors are being opened. This ensures that the force used to open the door does not exceed that permitted by law.



Danger.

If an object or a person becomes trapped during the opening procedure, the door valve can be changed back to the closing direction if the door pushbutton is pressed again. The door system can also be depressurised and thus switched to reduced-power pushback by the use of the emergency switch.

Locking the exterior emergency valve at door 2 (option)

Locking the exterior emergency valve at door 2 (option)

i Note:

If a bus without central locking is to be parked and left, it is possible to lock the emergency valve for door 2 from the outside (option). In this event, only the emergency valve is locked.

i Note:

If the bus is to be left for a relatively long period, it is necessary to lock the door from the inside. The door will then remain closed, even in the event of a loss of pressure.

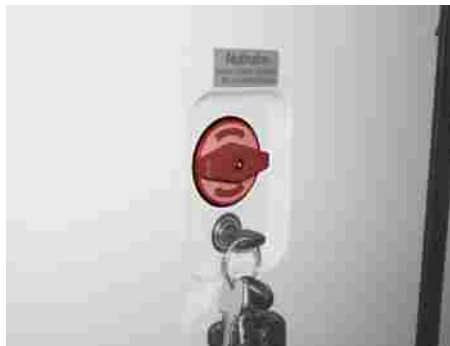

M72_00-0284-71

- ▶ Lock the emergency valve.
It is no longer possible to operate the emergency valve, and unauthorised access to the bus is prevented.
- ▶ Unlock the emergency valve again before commencing a journey.

i Note:

The drive-off lock remains active if the exterior emergency valve has not been unlocked before commencing a journey. It is not possible to set the bus in motion.

Operating/malfunction displays: doors

Door open



This icon appears if a door is still open or if a door is not closed properly (door not latched).

i Note:

Symbol is an example for door I (front right door).

Door malfunction warning - door I (front right) or door II (centre right)



A malfunction is present in the door system if this icon appears on the display screen while the bus is in motion or stationary. At the same time, a RED warn-

Operating/malfunction displays: doors

ing level malfunction message is displayed, the warning lamp in the door pushbutton flashes and the warning buzzer sounds.



Danger.

Stop the bus immediately (traffic conditions permitting). It is prohibited to move the bus at any time while this malfunction is present. Have an OMNIplus Service Partner check the door system immediately.



Danger.

This display also appears if the compressed-air supply in the door system is too low. Start the bus and charge the compressed-air supply. If the display still does not go out, have the door system checked by an OMNIplus Service Partner.



Danger.

This icon also appears when the emergency valve on the inside/outside of the front right or centre right door is operated (door depressurised).



Danger.

This icon also appears in the display if the bus is moving faster than 3 km/h and door I (front right) or door II (centre right) is open.



Note:

Symbol is an example for door I (front right door).

Ready to depart



This icon appears in connection with the bus stop brake or drive-off lock.



Note:

If the bus is equipped with a bus stop brake (option), this icon appears when the bus stop brake pushbutton is pressed.



Note:

If the bus is equipped with a drive-off lock, this icon will appear when the centre right door has completely closed following a closing procedure.



Note:

The bus stop brake and the drive-off lock are applied on all axles with reduced braking pressure and are released as soon as the accelerator pedal is depressed.

Unlocking the door circuit at the front right door

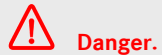
**Danger.**

The bus may roll away if the parking brake has not been applied.

Unlocking the door circuit at the front right door

**Danger.**

All doors must be unlocked before the bus is driven off.

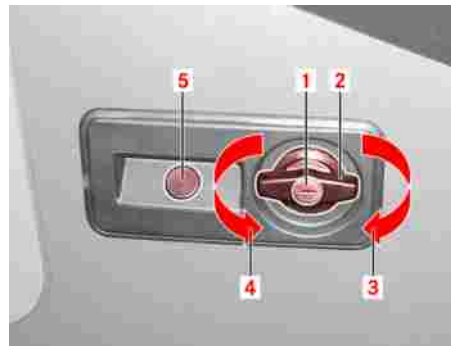

M72_00-0244-01

- ▶ To unlock the front right door, insert the key into lock (1), turn it clockwise and turn handle (2) to the right at the same time (arrow position 3). Turn the key and handle (2) back to their initial position and remove the key. Press exterior pushbutton (5).

**Note:**

The fuel filler flaps are unlocked when door 1 is unlocked.

**Danger.**

Door 2 is not unlocked at the same time.

Door 1 opens automatically.

Unlocking door 2

Unlocking door 2



M72_00-0188-01

- ▶ Turn interior handle (2) for door 2 to the left.



Danger.

Door 2 must be unlocked manually before the bus is driven off.

Unlocking the door circuit using the radio remote control (option)



Danger.

All doors must be unlocked before the bus is driven off.

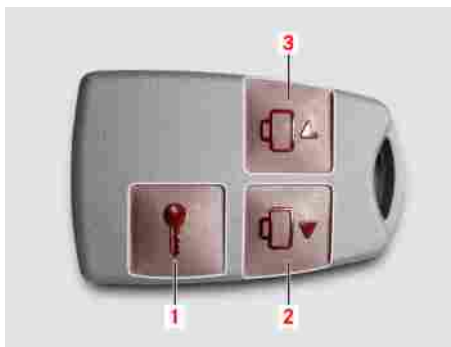

M82_00-0106-71

- ▶ Unlock door circuit (door I, door II, fuel filler flaps) using the remote control (button 1).

Unlocking of the door circuit is indicated by one long flash (maximum of 3 seconds) of the side-mounted turn signals.



Note:

If a door or luggage compartment flap is not opened within 20 seconds, the circuit will be relocked. This prevents the bus from remaining unlocked if it was unlocked by accident. Forced locking is initiated to conserve the battery charge if the luggage compartment flaps have still not been locked within 43 minutes of the ignition switch being switched to OFF.

Unlocking the luggage compartment flaps using the pushbuttons in the driver's area

Unlocking the luggage compartment flaps using the pushbuttons in the driver's area

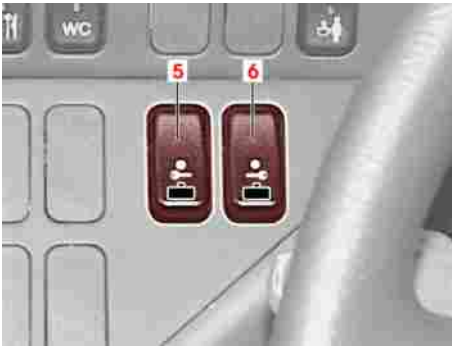

M82_00-0007-01

- ▶ Unlock the left-side luggage compartment flaps using pushbutton (5) and the right-side flaps using pushbutton (6).

i **Note:**

If the bus is equipped with central locking (option), the side-mounted turn signals flash briefly once (for approximately 1 second) when the luggage compartment flaps are locked and unlocked.

The left- or right-side luggage compartment flaps can be opened. The LEDs in pushbuttons (5) and (6) light up when the luggage compartment flaps are unlocked.

i **Note:**

There must be sufficient compressed air available.

i **Note:**

The luggage compartment flaps are re-locked either when the pushbutton in the driver's area is pressed again or when the ignition switch is turned to OFF.

i **Note:**

The luggage compartment lighting switches on automatically whenever a luggage compartment flap circuit (left or right) is unlocked.

Unlocking the luggage compartment flaps using the remote control (option)

Unlocking the luggage compartment flaps using the remote control (option)

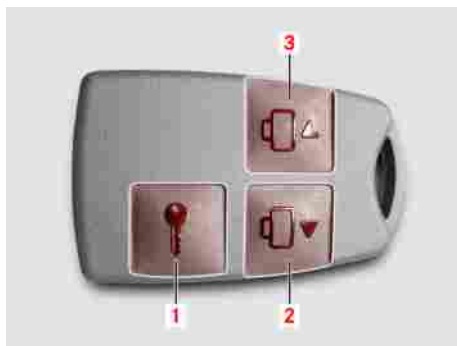

M82_00-0106-71

- ▶ Unlock the left-side luggage compartment flaps using remote control button 2 and the right-side flaps using button 3.



Note:

The turn signals flash (approximately 1 second) once if only the luggage compartment flaps have been locked or unlocked.

Luggage compartment flaps can be opened (the LED lights up in the cor-

responding luggage compartment flaps pushbutton in the driver's area depending on which side of the bus the luggage compartments are unlocked).



Note:

There must be sufficient compressed air available.

Locking door 2

- ▶ Close door 2



M72_00-0188-01

- ▶ To lock door 2, insert the key into lock (2.1), turn it clockwise and turn interior handle (2) to the right at the same time. Then turn the key back to its initial position and remove it with the handle in the locked position.

**Note:**

Do not turn handle (2) back again, otherwise you will unlock the door again.

Locking door 1

- Close door 1

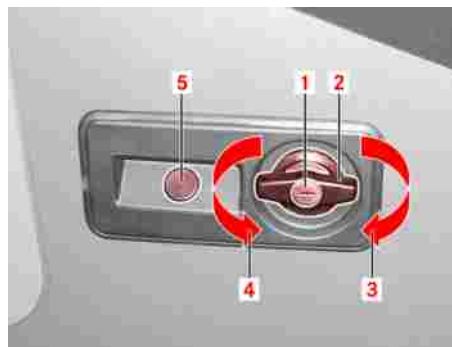

M72_00-0244-01

- To lock the front right door, insert the key into lock (1), turn it clockwise and turn handle (2) to the left (arrow position 4). Turn the key and handle (2) back to their initial position and remove the key.

**Note:**

The fuel filler flaps are locked when door 1 is locked.

**Note:**

Door 2 has to be locked separately.

Locking using the radio remote control (option)

Locking using the radio remote control (option)

- ▶ Close the doors

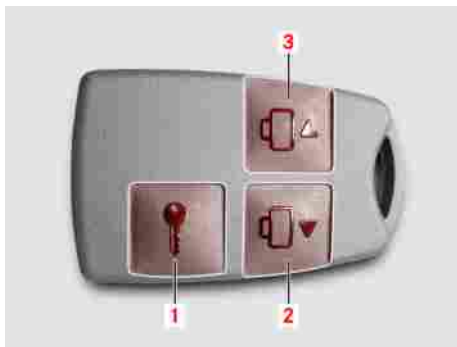

M82_00-0106-71

- ▶ When the radio remote control (button 1) is pressed, the bus is locked centrally, i.e. door and luggage compartment flap circuits are locked.



Note:

The side-mounted turn signals flash briefly 3 times (approximately 1 second) to confirm that the bus is locked.



Note:

If the key is used in the lock on the front right door in order to lock the bus, only the door circuit will be locked, i.e. any unlocked luggage compartment flaps will not be locked by this action.



Note:

The driver's window and service covers are neither closed nor locked automatically; these have to be closed or locked manually.



Note:

A buzzer sounds for 10 seconds if an attempt is made to lock the bus and the bus doors, luggage compartment flaps, roof hatches or driver's window have not been closed and locked.



Note:

The luggage compartment flaps can also be locked or unlocked using two pushbuttons in the driver's area when the ignition switch is switched on.



Note:

When the ignition switch is switched to OFF and the luggage compartment flaps are unlocked and closed, forced locking occurs after 43 minutes to conserve the battery charge.

Central locking system (option) (system description)



This icon on the screen (driver's area) indicates that a luggage compartment flap has not been closed correctly.

**Danger.**

Before the bus is driven off, carry out a visual inspection to make absolutely sure that all luggage compartment flaps and service covers are properly closed.

**Central locking system (option)
(system description)**

The central locking system may offer the following range of functions:

- Complete locking of the open bus using the radio remote control (FFB) with the ignition switch in the OFF position.
- Unlocking of the door circuit (front right door, centre right door, fuel filler flaps) using the remote control.
- Unlocking/locking of the door circuit using the lock on the front right door with the ignition switch in the OFF position.
- Unlocking/locking of the luggage compartment flaps using the FFB with the ignition switch in the ON or OFF position.
- Unlocking/locking of the luggage compartment flaps using rocker switch on the instrument panel with the ignition switch in the ON or OFF position.

- Relocking of the bus after inadvertent unlocking using the FFB.
- Forced locking of the luggage compartment flaps to conserve battery charge.

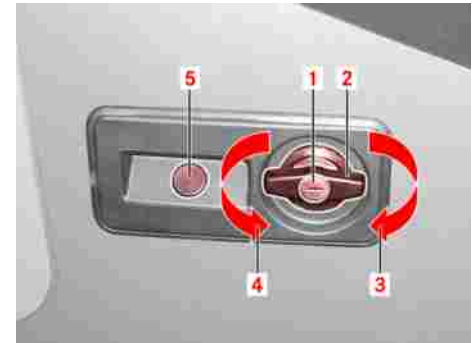

M72_00-0244-01

Locking/unlocking of the doors: It is possible to lock or unlock the door circuit (front right door, centre right door, fuel filler flaps) electrically by means of lock (1) on the front right door or by pressing button (1) on the radio remote control (FFB). A locking of the door circuit using the FFB is always accompanied by a simultaneous locking of the

Central locking system (option) (system description)

vehicle's entire central locking system. Unlocking of the doors is indicated by a long flash (maximum 3 seconds) from the side-mounted turn signals. When the door circuit is unlocked, the doorway lighting in the front right door comes on for a maximum of 30 seconds. It goes out if the ignition switch is switched to ON or if the doors are locked. Complete locking of the bus is indicated by the side-mounted turn signals flashing (1 second) three times. A locked door circuit is unlocked automatically when the engine is started.

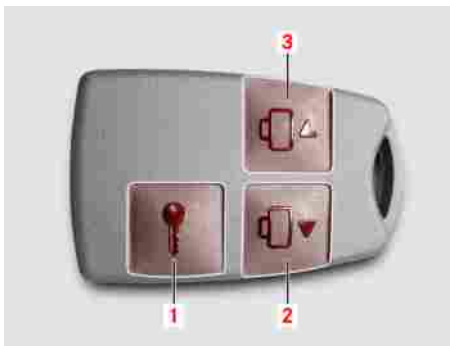

M82_00-0106-71

Locking/unlocking of the luggage compartment flaps: The left and right-side luggage compartment flaps can be locked or unlocked separately using FFB button (2) or (3). This is possible when the ignition switch is in the OFF or ON position or when the engine is running. If the unlock command was issued using the FFB, a flap must be opened within 20 seconds otherwise the bus will be locked again automatically. The LEDs light up in the rocker switches in the driver's station. The LEDs in the rocker switches go out if the doors are locked using the FFB. The side-mounted turn

signals flash once (1 second) whenever the FFB is used to lock or unlock the luggage compartment flaps.

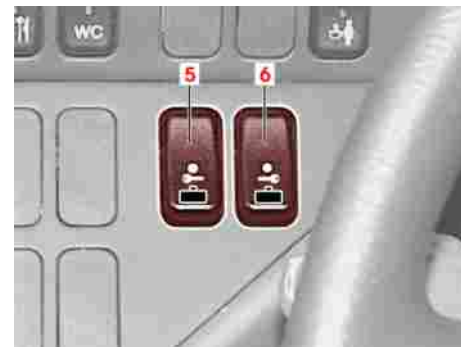

M82_00-0007-01

Locking/unlocking of the luggage compartment flaps (continued): With the ignition switch in the ON position, the flaps on the left-hand side and the flaps on the right-hand side can be electropneumatically locked or unlocked separately using rocker switch (5) and rocker switch (6) respectively. The LED in the pressed rocker switch lights up when the luggage compartment flap circuit is unlocked. Status message for the driver: LED lit - luggage compartment flaps un-

Central locking system (option) (system description)

locked. LED not lit - luggage compartment flaps locked. A symbol is shown on the instrument cluster display screen if a luggage compartment flap is open. The luggage compartment flap circuit can be locked even if a luggage compartment flap is open. The luggage compartment flap that was still open will also be locked once it is closed.

**Danger.**

Before the bus is driven off, carry out a visual inspection to make absolutely sure that all luggage compartment flaps and service covers are properly closed.

Luggage compartment lighting operation: The luggage compartment lighting is switched on if a luggage compartment flap circuit (left or right) is unlocked and at least one of the luggage compartment flaps is open.

The luggage compartment lighting is switched off again when all luggage compartment flaps are closed or both luggage compartment flap circuits (left and right) are locked. The luggage compart-

ment lighting is also switched off automatically after no more than 43 minutes (forced locking).

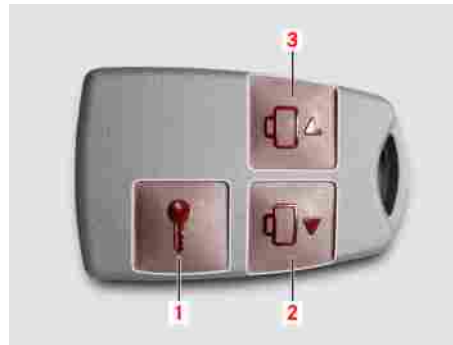

M82_00-0106-71

Complete locking of the bus: To have all parts of the bus locked simultaneously, it is necessary to use the FFB. To do so, press button (1) on the FFB. If the door circuit is already locked, it is not possible to centrally lock the entire bus directly using the FFB. At first, only the door circuit is unlocked when button (1) on the FFB is pressed for the first time; the complete bus is not locked until button (1) is pressed once more. Complete locking is acknowledged by

the side-mounted turn signals flashing 3 times (1 second). Change the radio remote control's battery if its operating range appears to be deteriorating.

**Environmental protection**

Dispose of used batteries in an environmentally responsible manner.

Security functions of the central locking system: Relocking - relocking is a security feature of the central locking. If the unlocking button on the FFB is pressed inadvertently, the bus will be relocked automatically if none of the doors or luggage compartment flaps are opened within 20 seconds. Forced locking - forced locking only affects luggage compartment flaps that have been unlocked by the central locking system. Forced locking is initiated (the solenoid valves are deactivated to reduce the off-load current in the system) if the luggage compartment flaps have still not been locked after more than 43 minutes with the ignition switched OFF.

Operating/malfunction displays: central locking

Operating/malfunction displays: central locking

Central locking of the left-side luggage compartment flaps



This symbol is displayed on the screen if the left-side luggage compartment flaps are unlocked using the pushbutton in the driver's area and no feedback is received from the pressure switch within 3 seconds. In this case, there is a fault in the left-side luggage compartment flap circuit and it may not be possible to open the luggage compartment flaps.



This symbol also appears if the supply of compressed air in the left-side luggage compartment flap circuit is too low - start the bus and charge the compressed-air supply.



Only in buses without central locking (ZV) (option).

Central locking of the right-side luggage compartment flaps



This symbol is displayed on the screen if the right-side luggage compartment flaps are unlocked using the pushbutton in the driver's area and no feedback is received from the pressure switch within 3 seconds. In this case, there is a fault in the right-side luggage compartment flap circuit and it may not be possible to open the luggage compartment flaps.



This symbol also appears if the supply of compressed air in the right-side luggage compartment flap circuit is too low - start the bus and charge the compressed-air supply.



Only in buses without central locking (ZV) (option).

Luggage compartment flap open (option)



This symbol appears on the screen if one or more luggage compartment flaps or service covers have not been locked correctly.

Emergency operation of the doors (depressurising the doors using the emergency valves)

**Danger.**

Before the bus is driven off, carry out a visual inspection to make absolutely sure that all luggage compartment flaps and service covers are properly closed.

**Note:**

Only in buses with central locking (ZV) (option) or luggage compartment flap warning display (option).

Emergency operation of the doors (depressurising the doors using the emergency valves)

**Danger.**

All doors must remain unlocked while the bus is in motion. - refer to Operating Instructions sections: "Opening/Locking", "Unlocking the door circuit at the front right door / Unlocking the centre right door / Unlocking the door circuit using the radio remote control (option)"

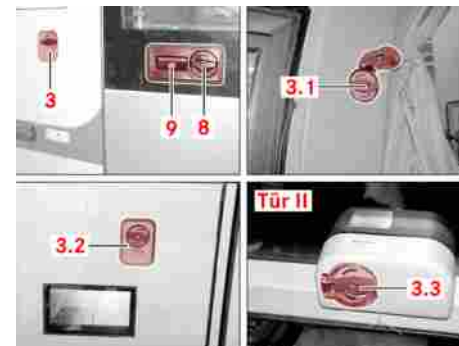

M72_00-0023-01

- ▶ Remove the security seal from the emergency valve.

**Note:**

3 Exterior emergency valve, front right door

**Note:**

3.1 Interior emergency valve, front right door

Emergency operation of the doors (depressurising the doors using the emergency valves)



Note:

3.2 Exterior emergency valve, centre right door



Note:

3.3 Interior emergency valve, centre right door

- ▶ Turn interior emergency valve (3.1/3.3) or exterior emergency valve (3/3.2) in the direction of the arrow.



Note:

When the emergency valve is operated, the door valve is vented of air. At the same time, the emergency valve also releases the air in the door system. The door system is now depressurised and it must now be possible to move the door manually.



The warning buzzer sounds in the driver's area. The red warning lamp in the relevant door pushbutton must flash. This symbol appears on the instrument cluster display screen together with a red alert.

- ▶ Restoring operation of the door system: - move the emergency valve into the normal position – the door compressed-air system is slowly refilled through a door actuation throttle valve and returns to the condition it was in before the emergency valve was operated.



Danger.

Risk of injury. Make sure that nobody is within the sweep of the door leaf when operation of the door system is restored. Doors must not move with a jerky or jolting action after normal operation has been restored.

- ▶ Provide the emergency valve with a new security seal.

Emergency unlocking of the luggage compartment flaps in the event of a compressed-air supply failure

Emergency unlocking of the luggage compartment flaps in the event of a compressed-air supply failure

i Note:

If there has been a complete failure of the central compressed-air supply and the electrical power supply, the luggage compartment flaps can be emergency-unlocked by means of an emergency operating facility (spare wheel compressed-air reserve).



M00_00-0084-01

- ▶ Open the front cover of the bus using lever (1) at the front right door entrance
- ▶ Remove the spare wheel

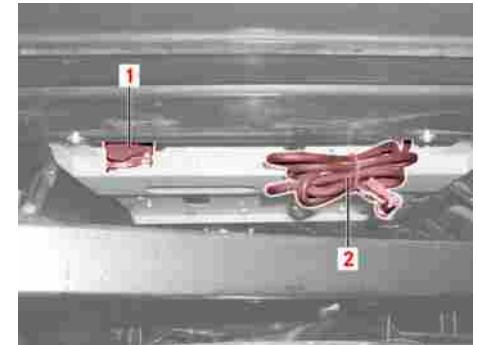

M40_00-0073-01

- ▶ Take the hose with tyre connection (2) from the plate behind the heating front cabinet and connect it to the tyre inflation valve on the spare wheel.

i Note:

The spare wheel has a pressure of approximately 8 bar. The compressed air in the spare wheel passes through shuttle valves to the cylinders of the luggage compartment locking system and unlocks the luggage compartment flaps. The luggage compartment flaps can then be opened.

Opening/closing the service cover under the driver's window



Note:

Reinflate the spare wheel to the specified pressure as soon as possible.

Opening/closing the service cover under the driver's window

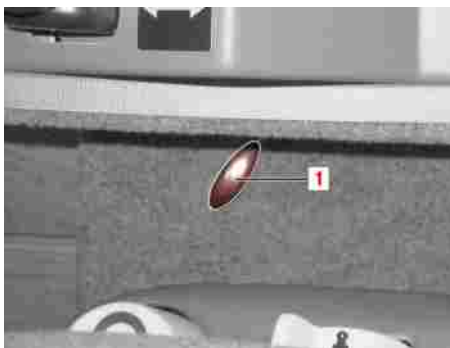

M00.00-0591-71

- ▶ To release: to release the service cover, pull handle (1).



Danger.

Do not pull the release lever while the vehicle is in motion. Otherwise, the service cover could open.



Note:

Handle (1) is located on the floor of the bus to the left-hand side of the driver's seat.

The service cover is released.



M00.00-0655-71

- ▶ To open: open service cover (1) towards you.

Opening/closing the roof hatches manually

- ▶ To close: close service cover (1) with a gentle push.

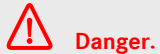
**Danger.**

When you close the service cover, there is a risk of injury from entrapment.

You should hear the service cover engage. Check whether the service cover has engaged correctly.

Opening/closing the roof hatches manually

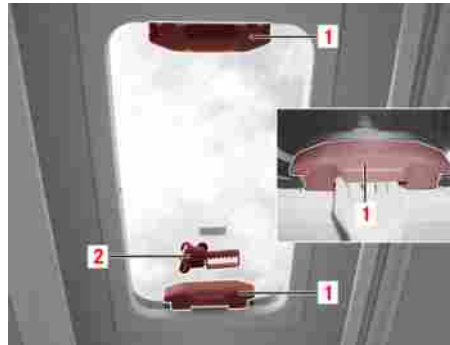

M77_00-0020-71

- ▶ Open the roof hatch to the front or rear of the bus manually using handle (1).

**Note:**

The roof hatches can be moved into the air-in or air-out position.

**Danger.**

There is a risk of injury and entrapment if parts of the body (fingers) are in the area of movement of the roof hatches.

- ▶ To open the roof hatch in an emergency, remove emergency hammer (2) from the bracket and strike the glass.

**Note:**

The emergency hammer must only be used in an emergency and with the bus stationary.

Emergency exit through emergency operation of the electric roof hatches (option)

Emergency exit through emergency operation of the electric roof hatches (option)



Danger.

The emergency release is only for use in an emergency and when the bus is stationary.



Note:

Both emergency exits (front and rear roof hatches) are unlocked as soon as the bus is unlocked by the central locking system, the lock at door 1 is unlocked or whenever the ignition starter switch is switched to ON. They are relocked as soon as the ignition starter switch is switched to OFF and the bus is locked by the central locking system or the lock at door 1 is locked.

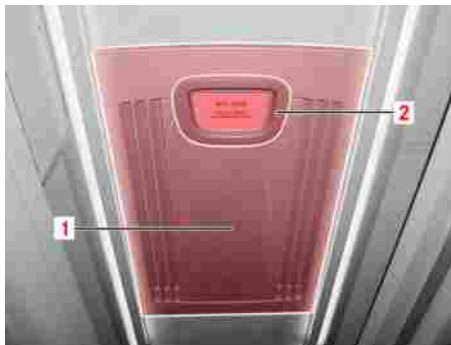

M77_00-0017-01

- ▶ Remove cover (1) by pulling on handle (2) (Velcro fastener) to gain access to the emergency exit roof hatch.



M77_00-0016-01

- ▶ Emergency operation is initiated by means of a red exterior or interior twist handle (1).



Note:

In emergencies, interior twist handle (1) must be turned in the direction of the arrow (clockwise). The emergency exit cover (2) can now be secured by a safety rope and placed to one side outside the bus.

Emergency exit through emergency operation of the electric roof hatches (option)



This symbol appears on the driver's area display screen in the event of emergency operation or if an outside handle on one of the emergency exit roof hatches is in locked condition with the ignition starter switch ON.

**Danger.**

Following emergency operation of an emergency exit roof hatch, it is necessary to have the cover fitted by specialist personnel at an OMNIplus Service Partner.

General information	266
Instructions for operating a microwave oven	267
Use for the intended purpose	269
Approved personnel	269
First use of the galley	270
Switching on the galley	271
Filling the fresh water tank inside the bus	272
Filling the fresh water tank outside the bus	274
Checking and cleaning the fresh water filter	274
Drawing water from the water tap	275
Switching on the boiler	276
Descaling the boiler	277
Switching on the sausage heater	279
Cleaning the sausage heater	282
Descaling the sausage heater	282
Switching on the 40-cup coffee machine	283

Table of contents

Brewing coffee in winter	287
Cleaning the 40-cup coffee machine	287
Switching on the 2-carafe filter system	288
Brewing 1/2 a carafe of coffee (10 cups of coffee)	289
Brewing 1 carafe of coffee (20 cups of coffee)	289
Brewing 2 carafes of coffee (40 cups of coffee)	290
Manual operation of the 2-carafe filter system	291
Descaling the coffee machine	292
Winter operation	293
Draining the fresh water tank	293
Draining the water lines	294
Draining the boiler	295
Draining the 40-cup coffee machine	296
Draining the 2-carafe filter system	296
Draining the siphon	297
Replacing fuses	298

Malfunctions	300
Restoring boiler operation following a malfunction	300
Using the sausage heater again after a malfunction	301
Using the 40-cup coffee machine again after a malfunction	302
Using the 2-carafe filter system again after a malfunction	303
Other malfunctions	304
Switching off the galley	305

General information

General information



Caution:

Never operate the equipment without water. Risk of thermal damage - loss of warranty.



Danger.

To avoid the risk of fire and damage, it is prohibited to store anything inside the sausage heater or microwave oven.



Danger.

Use only clean drinking water.



Danger.

To prevent the growth of microbes in water left inside the system, the entire system must be drained (refer to “Winter operation”) if the galley and/or lavatory is to remain out of service temporarily.



Note:

It is advisable to disinfect water-carrying systems at regular intervals or after operation has been restored. A sodium hypochloride solution (from camping and caravanning retailers) is particularly suitable; observe the manufacturer's instructions.



Caution:

Do not use the coffee machine, water boiler or sausage heater unless the kitchenette is open. Damage caused by heat and steam when the kitchenette is closed is not covered by the warranty.



Danger.

Secure loose objects in the kitchenette (cans, cups, lids, etc.) properly during the journey.



Note:

Waste water from the galley flows into the lavatory's holding tank.



Environmental protection

Dispose of waste in an environmentally responsible manner. The rules and regulations of the country in which the vehicle is operated must be observed.

Instructions for operating a microwave oven

Instructions for operating a microwave oven

**Caution:**

Never use the oven when it is empty. Place at least one glass of water in the oven if you want to carry out a test. No metal objects should be placed in the oven interior as this would result in sparking and damage to the oven.

**Danger.**

Living animals or body parts must not be exposed to microwaves.

**Danger.**

To reduce the risk of a fire breaking out as a consequence of overheated food, the microwave oven must never be operated without supervision. If food catches fire, switch the microwave oven off but do not open the oven doors.

**Danger.**

Microwaves only heat up foods containing water; this means that the container may feel cold but the food inside could be boiling hot. To eliminate the risk of burns, the temperature of the food must therefore be checked before the food is served. This applies to the preparation of food for children or babies in particular.

**Danger.**

The rules below for handling microwave ovens must be adhered to in order to reduce the risk of microwaves causing burning, electric shocks, radiation and fire:

- Only use suitable containers. A container is suitable for use in the microwave oven if it remains cold after having been heated in the oven for one minute at maximum power.
- Do not operate the microwave oven with the door open, it is possible that

dangerous microwave energy may escape.

- Do not bridge the door safety circuit.
- Do not place any objects between the microwave oven door and the oven interior, keep the door seals clean.
- Do not use the oven if it is faulty.
- Only allow the microwave oven to be repaired by a specialist workshop.
- All openings on the microwave oven (ventilation in and out) must be free.
- Never allow children to use the microwave oven unless they are supervised.
- To reduce the risk of fire in the oven interior: foodstuffs must never be overheated, binding wires must be removed from paper or plastic packaging.
- Do not heat popcorn in the microwave oven unless you do this using a popcorn insert or use special popcorn.

Instructions for operating a microwave oven

- Only use thermometers recommended for use in microwave ovens to measure the temperature of foodstuffs in the oven.
- Our instructions must be closely followed when cooking pork. The meat must be heated to at least 70 °C so that any bacteria that may be present will definitely be destroyed.
- Frozen drinks contained in narrow-necked bottles, especially carbonated drinks, must not be defrosted in the microwave oven. Pressure can form even in open containers with the effect that the container may explode and cause injuries.
- Foodstuffs must not be overcooked. If, for instance, potatoes are overcooked they can dry out and become a fire risk.
- Cooking of eggs (in or not in a shell) in the microwave oven cannot be recommended. The pressure in the egg yolk could cause the egg to explode and cause injuries.
- Foodstuffs in skins, such as potatoes, sausages, tomatoes, chicken livers and other offal, eggs, etc., should be pierced so that steam generated by cooking can escape.
- Microwaveable bags and sealed plastic bags should be cut open or pierced to prevent them exploding during cooking and possibly causing injuries. Plastic containers should be opened at least a small amount. After containers have been cooked while they were sealed with plastic foil, the cover must be removed in such a way that escaping steam does not come into contact with the hands or face.
- The microwave oven must not be used to dry paper (newspapers). They can catch fire if overheated.



Danger.

When liquids (water) are heated in the microwave oven, and especially reheated, it can sometimes happen that the boiling temperature has been reached but the typical steam bubbles do not initially form. The liquid does not boil uniformly. When the container is removed (shaken) this boiling delay, as it is called, can suddenly cause steam bubbles to form and therefore start to boil over suddenly - risk of scalding. To prevent this, it is necessary to place a glass rod in the container, for instance. The glass rod ensures that fluid in the container boils uniformly and therefore the steam bubbles form at the usual time.

**Note:**

Clean microwave ovens after they have been used with a commercially available washing detergent, do not use abrasive cleaner. Switch off the ignition when doing this. If it is necessary to clean dried-on food residue from the oven interior, it can be softened by placing a glass of water in the oven and boiling it for approximately 10 minutes.

Use for the intended purpose

The galley and its equipment are intended for normal kitchen use during a bus journey. This includes:

- Boiler for hot water preparation
- Coffee machine for brewing coffee
- Sausage heater for preparing sausages

Any other use cannot be considered use for the intended purpose.

Approved personnel

The kitchenette may only be used by trained personnel. The personnel must be professionally qualified and have read and understood this section.

The safety of the person using the kitchenette and the security of all kitchen utensils are prerequisites for use of the kitchenette while the bus is in motion.

**Danger.**

Objects being thrown out of the kitchenette can cause injuries. The person using the kitchenette must secure loose objects safely while the bus is in motion.

First use of the galley

First use of the galley

- ▶ Galley switched on
- ▶ Fresh water tank filled and connected
- ▶ All packaging materials must be removed before the galley is used for the first time. All utensils must be thoroughly cleaned and rinsed in fresh water.



Environmental protection

Dispose of the packaging material in an environmentally responsible manner.

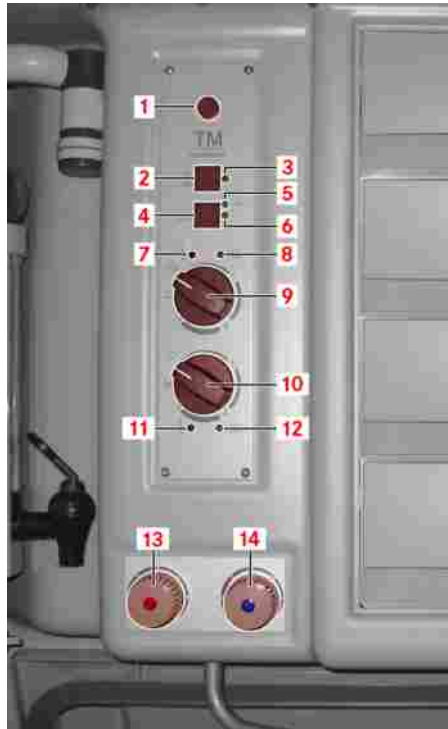

M86_00-0375-73

- ▶ Press button (4) on the control panel and keep it pressed (yellow LED (6) flashes) until green LED (5) lights up.

The boiler has been filled and bled and can now be switched on using control button (9) to draw hot water.



Note:

To avoid scale and steam, do not turn control knob (9) to maximum temperature unless you need very hot water.

- ▶ Before first use, clean the sausage heater tank, the lid and the overflow pipe thoroughly with hot water and a commercially available washing up liquid, and then rinse well with clean water. Then wipe the sausage heater tank dry to avoid scaling.
- ▶ To clean the coffee machine, fill it with water and brew the water without coffee powder but with the filter holder fitted, then repeat.

The galley is ready for use.

Switching on the galley

**Note:**

The coffee machine, boiler, sausage heater and microwave oven cannot be operated unless the engine is running.



M86_00-0058-01

- ▶ Press galley master switch (1).
The LED in master switch (1) lights up.

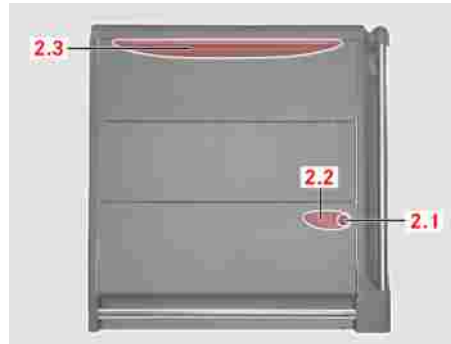

M86_00-0140-01

- ▶ Release folding cover on lock (2.1) by unlocking and pressing it. Pull handle (2.2). Fold the upper part of the folding cover down by handle (2.3).

**Danger.**

Since the counter protrudes into the steps area, the kitchenette should be switched off and closed before passengers embark or disembark. Risk of injury.

**Note:**

The lower and middle covers can now be used as a counter.

Filling the fresh water tank inside the bus

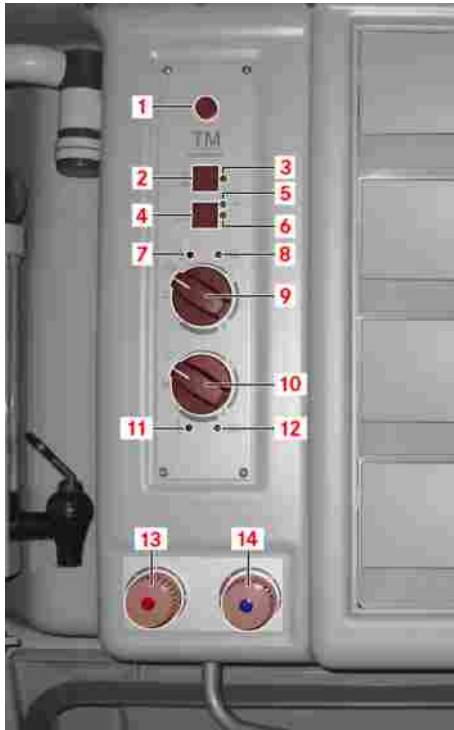

M86_00-0375-73

- ▶ Switch on the galley lighting using button (2) on the galley control panel.

The LEDs of the galley lighting come on and indicator lamp (3) lights up.

The galley is open and ready for use.

Note:

If indicator lamp (3) on the control panel does not light up, there is insufficient on-board voltage to operate the kitchenette. Start the engine to enable the batteries to recharge.

Filling the fresh water tank inside the bus

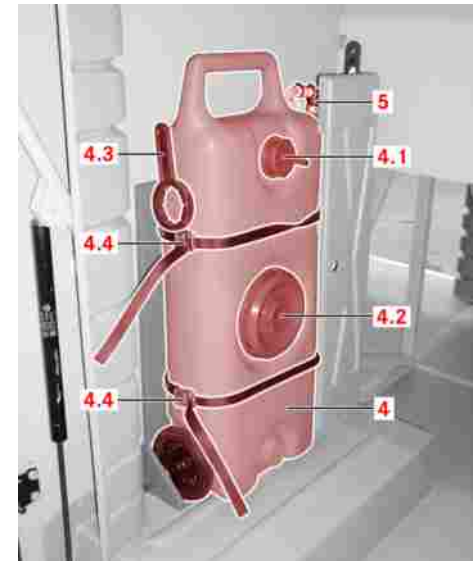

M86_00-0142-02

- ▶ Fill fresh water tank (4) via cap (4.1).

Filling the fresh water tank inside the bus

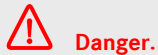
**Danger.**

The kitchenette must be operated using clean and potable water only. Fresh water for kitchenette requirements must be renewed every day. If the fresh water is stored in the water tank for a long period of time, an additive (Micropur, mat. no. 0.971.407.000) in accordance with the manufacturer's instructions must be mixed with it.

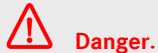
**Danger.**

The tools used to fill with water (containers, funnels, hoses, etc.) must be sterile.

**Note:**

It is recommended that fresh water tank (4) be cleaned manually via caps (4.1) and (4.2) and/or that it be flushed thoroughly with fresh water. The fresh water lines should then also be flushed with fresh water by drawing cold/hot water and switching on the coffee machine.

**Note:**

Use spanner (4.3) if the caps are difficult to turn.

**Note:**

In new buses, the drinking water may sometimes taste of plastic. An additive (Kunststoff-Frisch, mat. no. 0.971.405.000) can be mixed in accordance with the manufacturer's instructions to neutralise this aftertaste.

**Note:**

The fresh water tank is located in the luggage compartment in front of the lavatory, and in the right-hand luggage compartment to the rear of the driven axle on earlier bus models.

**Note:**

Waste water from the kitchenette flows into the lavatory's holding tank.

Filling the fresh water tank outside the bus

Filling the fresh water tank outside the bus

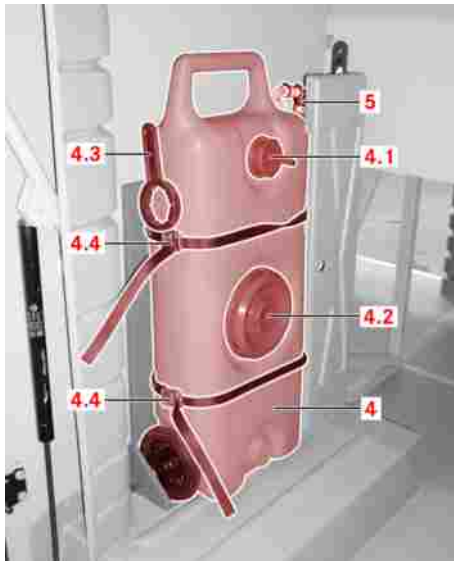

M86_00-0142-02

- ▶ Disconnect quick-release coupling (5) from fresh water tank (4).

- ▶ Release tensioning straps (4.4). Remove fresh water tank (4).
- ▶ Fill fresh water tank (4) with pure drinking water via cap (4.2). Close cap (4.2) firm and tight.
- ▶ Fit fresh water tank (4) into the bus and secure using tensioning straps (4.4).
- ▶ Connect quick-release coupling (5) to fresh water tank (4).

Checking and cleaning the fresh water filter

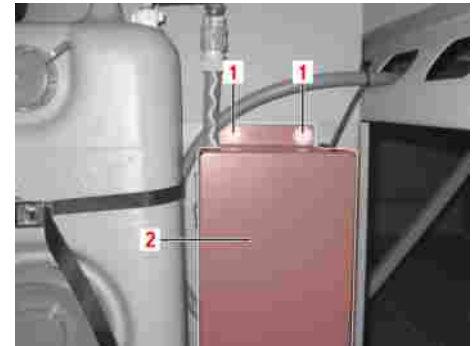

M86_00-0376-71

- ▶ The fresh water filter is located behind cover (2). Unscrew knurled screws (1) to permit removal of the cover.

Drawing water from the water tap

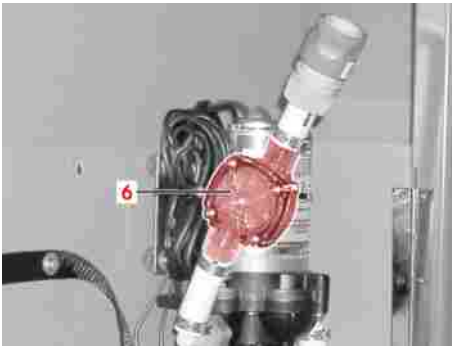

M86_00-0143-01

- ▶ Check fresh water filter (6) for clogging at regular intervals (depending on the water quality) and clean it if necessary.

**Note:**

The fresh water filter is located between the fresh water tank and the fresh water pump.

Drawing water from the water tap

- ▶ Galley switched on
- ▶ Fresh water tank filled and connected

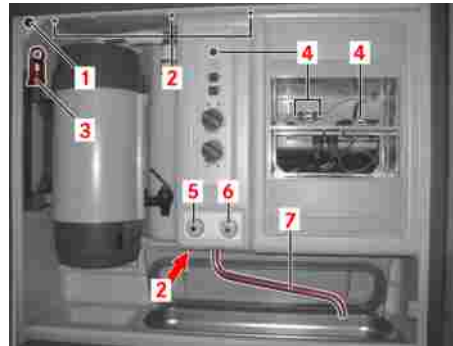

M86_00-0377-71

- ▶ Open rotary knob (6) to draw cold water from tap (7).

- ▶ Open rotary knob (5) to draw hot water from tap (7).

**Danger.**

Outflow of hot water - danger of scalding.

**Note:**

No hot water can be drawn unless the boiler is in operation. It takes approximately 20 minutes for the water to heat up to a set temperature of 80 °C.

**Note:**

Opening both rotary knobs (5) and (6) draws a mixture of hot and cold water.

Switching on the boiler

Switching on the boiler

- ▶ Galley switched on
- ▶ Fresh water tank filled and connected



Caution:

There is a risk of overheating and thermal damage if the boiler is operated with no water. Never operate the boiler without water.

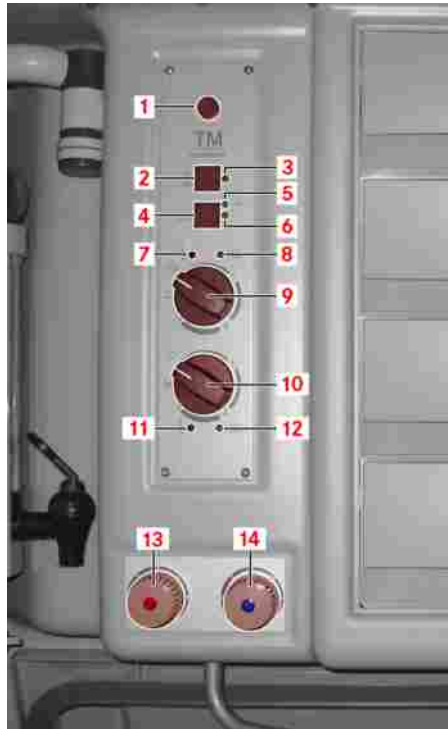

M86_00-0375-73

- ▶ Before you switch on the boiler, press and hold button (4) until green LED (5) lights up in order to make sure that the boiler contains water.

The boiler has been filled with water and bled.

- ▶ To switch on the boiler, turn control knob (9) clockwise. Green LED (8) above control knob (9) lights up and the water is heated.



Note:

The boiler switches off when you turn control knob (9) back. Green LED (8) goes out.



Note:

If red LED (7) lights up, the boiler has overheated and must be switched off by turning control knob (9) fully anti-clockwise (position 0) until the boiler has cooled down.

The boiler heats up the water and automatically switches off when the

temperature set at the control knob has been reached. LED (8) goes out.



Note:

The boiler has a capacity of approximately 5 litres and it takes approximately 20 minutes for the water to heat up to a set temperature of 80 °C.

Descaling the boiler



M86_00-0142-02

- ▶ Disconnect the hose at quick-release coupling (5).



Note:

How frequently the galley should be descaled depends on the water quality but the boiler should be descaled immediately if there is a noticeable increase in the length of the heating phase. It is advisable to descale the boiler twice a year.

- ▶ Hold the hose in a container of descaler (at least 10 litres).



Note:

Use only descalers that are suitable for domestic appliances. The descaler must be non-aggressive to plastics and aluminium. Observe the information provided by the manufacturer.

Descaling the boiler



Note:

Fully drain the boiler descaling.

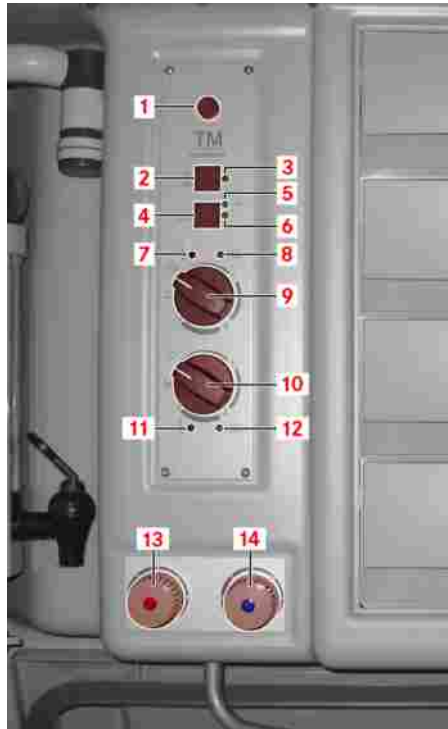

M86_00-0375-73

- ▶ Press and hold pushbutton (4) until green LED (5) lights up.

The boiler has been filled with descaler.

- ▶ To switch on the boiler, turn control knob (9) fully clockwise (position 3).

LED (8) lights up and the water containing descaler is heated.

- ▶ Wait until LED (8) goes out.

The contents of the boiler have been heated.



Note:

The boiler has a capacity of approximately 5 litres and it takes approximately 20 minutes for the water to heat up to a set temperature of 80 °C.

- ▶ Drain the water and descaler by opening tap (5).

Switching on the sausage heater

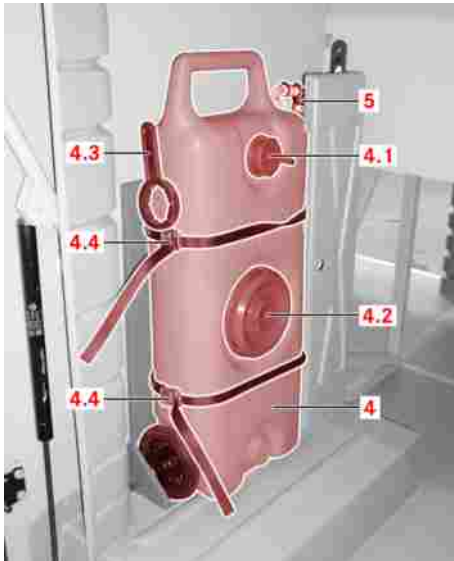

M86_00-0142-02

- ▶ Connect the hose to fresh water tank (4).

- ▶ Flush the boiler with plenty of fresh water. To do this, fill the boiler with fresh water, heat the water and drain it.

i Note:

Repeat the last step until the water no longer tastes or smells of descaler or vinegar.

Switching on the sausage heater

- ▶ Galley switched on
- ▶ Fresh water tank filled and connected

! Danger.

There is a risk of scalding when using the sausage heater. Hot steam can rise, which may cause serious burns to the face, arms and hands. Keep at a safe distance, and remove hot sausages using only heat-resistant kitchen utensils.

i Note:

The length of the heating phase depends on the amount of water, the number of sausages and the temperature of the water used to fill the boiler.

Switching on the sausage heater



Note:

The sausage heater has a capacity of 8.5 litres.



Note:

Waste water from the galley flows into the lavatory's holding tank.

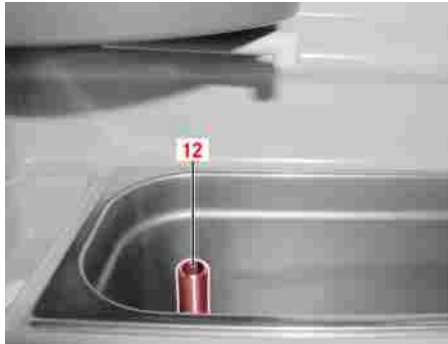

M86_00-0149-01

- ▶ Insert overflow pipe (12) into the discharge hole, ensuring leak-tightness.



Danger.

Never use the sausage heater without water.



Note:

Excess water may run out via overflow pipe (12).

- ▶ Fill the sausage heater tank half full (approximately 2 - 3 litres) with cold or hot water.
- ▶ Add the sausages to the sausage heater tank and replace the lid on the sausage heater tank.



Note:

When adding sausages, there is a risk of hot water splashing and causing burns to the face, arms and hands. Add the sausages to the water carefully and keep a safe distance.

Switching on the sausage heater

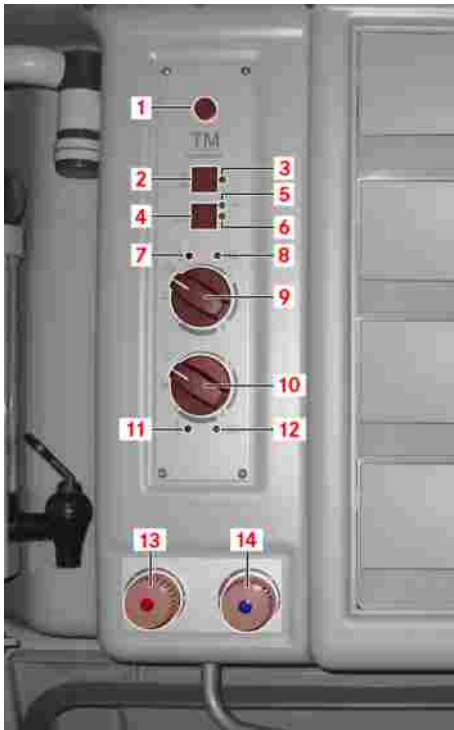

M86_00-0375-73

- ▶ Switch on the sausage heater by turning control knob (10).
Green LED (12) lights up during the heating phase.

i **Note:**

If red LED (11) lights up, the sausage heater has overheated and must be switched off by turning the control knob fully anti-clockwise (position 0) until the heater has cooled down.

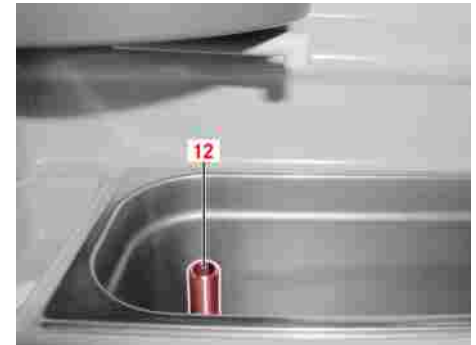

M86_00-0149-01

- ▶ At the end of the heating phase, remove the lid.

! **Danger.**

The sausage heater is hot and generates steam - risk of scalding. Do not remove overflow pipe (12) until the water in the tank has cooled sufficiently that there is no longer a risk of scalding.

- ▶ Take out the sausages using tongs or a suitable heat-resistant kitchen utensil.

Cleaning the sausage heater

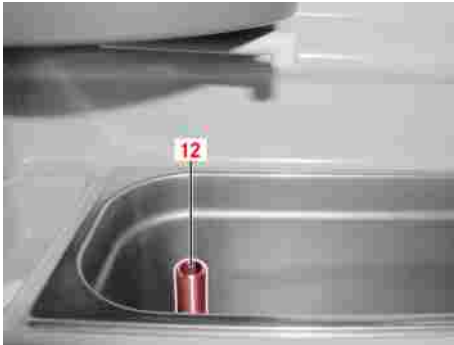

M86_00-0149-01

- ▶ The water in the sausage heater tank can be drained as soon as the water has been allowed to cool down. To do this, remove overflow pipe (12) from the discharge hole.

Cleaning the sausage heater

- ▶ After use, clean the sausage heater tank, the lid and the overflow pipe with warm water and a commercially available washing up liquid. Use a soft sponge without a scourer or similar abrasive product. Rinse with clean water and wipe the sausage heater tank dry to avoid scaling. Clean the overflow pipe with bottle cleaner at regular intervals.



Note:

Clean the sausage heater tank with a commercially available stainless steel cleaner at regular intervals.

Descaling the sausage heater

- ▶ Fill the sausage heater tank 2 cm high with descaler.
- ▶ Leave the descaler to work (observe the information issued by the manufacturer).



Note:

For heavy scaling, it is possible to operate the sausage heater containing descaler for approximately 30 minutes at 80 °C.

- ▶ Drain the boiler after the descaler reaction time and rinse well with clean water. Wipe the sausage heater tank dry.

Switching on the 40-cup coffee machine

Switching on the 40-cup coffee machine

- ▶ Galley switched on
- ▶ Fresh water tank filled and connected



Note:

There is a risk of scalding when serving hot drinks. There is a risk of serious burns. Do not pour the coffee until it is safe to do so.



Danger.

Do not switch on the coffee machine unless its tank has been filled with water - risk of overheating.

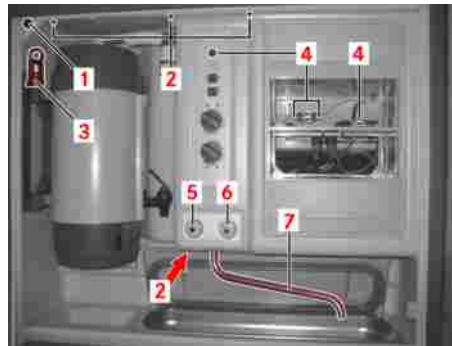

M86_00-0377-71

- ▶ Pulling release handle (3) up makes it possible to pivot the coffee machine out of the kitchenette



M86_00-0010-01

- ▶ Pivot the 40-cup coffee machine out of the galley. Close residual drain valve (24) and tap (23).

Switching on the 40-cup coffee machine



M86_00-0008-01

- ▶ Open the lid. Turn lock ring (17) anti-clockwise and unlock it.



M86_00-0010-01

- ▶ Remove lock ring (17) and lid (18) and take out filter holder (19).
- ▶ Pivot the 40-cup coffee machine into the galley until it engages.



M86_00-0378-71

- ▶ Open tap (1) to fill the 40-cup coffee machine with water.



Note:

The minimum amount of water to fill the 40-cup coffee machine is the equivalent of 10 cups. The maximum amount of water is the equivalent of 40 cups. The number of cups is indicated at water level glass (21).

Switching on the 40-cup coffee machine



M86_00-0010-01

- ▶ Insert the filter paper into filter holder (19) and fill filter holder (19) with the required amount of coffee (1 mark ring = 10 cups).

i **Note:**

You can also use the machine without paper if the coffee has not been ground too fine.

- ▶ Close filter holder (19) and lid (18) and place it on the riser pipe in the machine.



M86_00-0008-01

- ▶ Position lid (18) and lock ring (17) on top and engage by turning anti-clockwise:

i **Note:**

Lug (17.1) must be positioned over water level glass (21).



M86_00-0010-01

- ▶ Switch on the 40-cup coffee machine using rocker switch (22). The brewing process begins.

! **Danger.**

Whilst coffee is being brewed, steam escapes from the openings in the lid. Do not open the lid when the coffee machine is switched on.

Switching on the 40-cup coffee machine



Note:

Indicator lamp (22.1) lights up when the coffee has finished brewing.



Note:

The coffee is kept warm as long as rocker switch (22) has not been switched off.



Note:

Do not switch off the coffee machine during the keep-warm phase because a new brewing process would begin when the machine were switched back on - coffee quality would be degraded.

- ▶ Push tap (23) down to pour coffee. Lock it in the vertical position for continuous pouring.



Note:

Lock the tap in the vertical position for continuous pouring.

- ▶ Switch off rocker switch (22) if there is no more coffee in the coffee machine or no more coffee is needed.



M86_00-0159-02

- ▶ Drain off the remaining coffee with residual drain valve (24).

Brewing coffee in winter

**Caution:**

Operation of the 40-cup coffee machine in winter is permitted only once it has been established that the interior of the kitchenette is not frozen, otherwise there is a risk of damage. The interior compartment of the bus should be heated for some time beforehand.



M86_00-0010-01

- ▶ Remove lid (18) and filter holder (19). Use a suitable vessel to fill water into the coffee machine container and switch on the machine.

Cleaning the 40-cup coffee machine

- ▶ Galley switched on

**Note:**

Regular cleaning after each use ensures optimum coffee quality and full taste.

- ▶ Clean the filter holder using a commercially available washing up liquid and a brush. Do not use a descaler when cleaning the filter holder.
- ▶ Clean the inside of the riser pipe of the 40-cup coffee machine with a cloth and stainless steel cleaner.

**Note:**

The bottom of the tank, the opening on the riser pipe and the diaphragm must be free of coffee residues.

- ▶ To remove the water level glass, remove the catch at the top. Clean the water level glass using a pipe cleaner or a bottle brush. After cleaning, press the catch back into the water level glass, ensuring leak-tightness.

Switching on the 2-carafe filter system

- ▶ To clean the tap, unscrew the upper part with rocker arm and flush with clean water.
- ▶ Flush the residual drain valve with clean water.

Switching on the 2-carafe filter system

- ▶ Galley switched on
- ▶ Fresh water tank filled and connected



Caution:

Running programs cannot be interrupted. If there is a power failure, it will be necessary to restart the program. If the carafes contain coffee from a previous program, they must be drained first to avoid the risk of overflowing.



Caution:

To avoid the risk of overflowing, make sure that the carafes are empty before the brewing process begins.



Note:

The coffee filter must equate to size 1 x 6 (commercially available). Add the amount of coffee powder according to taste (e.g. 1 teaspoon per cup).

- ▶ The 2-carafe filter system is able to fill two carafes with a capacity of 2 litres. This is sufficient to pour 40 100 ml cups of coffee. It is possible to brew 1/2 a carafe, 1 carafe or 2 carafes of coffee.

Brewing 1/2 a carafe of coffee (10 cups of coffee)

Brewing 1/2 a carafe of coffee (10 cups of coffee)



M86_00-0151-01

- ▶ Remove left-hand filter (25). Insert filter paper and add as much coffee powder as required.

**Note:**

Add coffee powder to taste (e.g. 1 teaspoon per cup, which corresponds to 10 teaspoons for half a carafe of coffee).

- ▶ Slide left-hand filter (25) back into position.
- ▶ Place an empty carafe (26) under left-hand filter (25).



M86_00-0153-01

- ▶ Press button (30) on the control panel.
The LED in button (30) lights up. The brewing process begins.
- ▶ An electronic signal sounds when brewing has finished.
The LED in button (30) goes out.

Brewing 1 carafe of coffee (20 cups of coffee)



M86_00-0151-01

- ▶ Remove left-hand filter (25). Insert filter paper and add as much coffee powder as required.

**Note:**

Add coffee powder to taste (e.g. 1 teaspoon per cup, which corresponds to 20 teaspoons for one carafe of coffee).

Brewing 2 carafes of coffee (40 cups of coffee)

- ▶ Slide left-hand filter (25) back into position.
- ▶ Place an empty carafe (26) under left-hand filter (25).

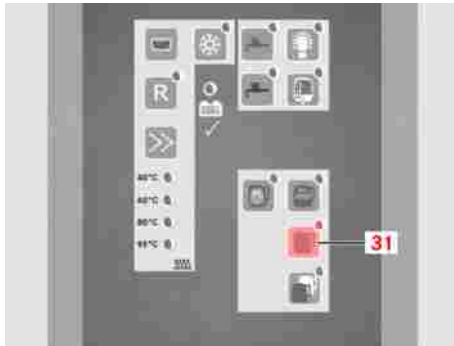

M86_00-0154-01

- ▶ Press button (31) on the control panel.

The LED in button (31) lights up. The brewing process begins.

- ▶ An electronic signal sounds when brewing has finished.

The LED in button (31) goes out.

Brewing 2 carafes of coffee (40 cups of coffee)



M86_00-0152-01

- ▶ Remove left-hand filter (25) and right-hand filter (27). Insert filter paper and add as much coffee powder as required.

i Note:

Add coffee powder to taste (e.g. 1 teaspoon per cup, which corresponds to 20 teaspoons for one carafe of coffee).

- ▶ Slide left-hand filter (25) and right-hand filter (27) back into position.
- ▶ Place two empty carafes (26) and (28) under left-hand filter (25) and right-hand filter (27) respectively.



M86_00-0155-01

- ▶ Press button (32) on the control panel.

The LED in button (32) lights up. The brewing process begins.

Manual operation of the 2-carafe filter system

- ▶ An electronic signal sounds when brewing has finished.

The LED in button (32) goes out.

Manual operation of the 2-carafe filter system

i **Note:**

Button (33) is not required for normal operation. It can be used to drain off any residual water in the coffee machine water tank.



M86_00-0151-01

- ▶ Place an empty carafe on the left-hand side.



M86_00-0156-01

- ▶ Press button (33).

The water in the 2-carafe filter system is boiled out.

The water in the 2-carafe filter system is completely drained.

Descaling the coffee machine

Descaling the coffee machine



Note:

How frequently the galley should be descaled depends on the water quality but the coffee machine should be descaled immediately if performance deteriorates or if the openings in the filter begin to scale up.



M86_00-0142-02

- ▶ Disconnect the hose at quick-release coupling (5).

- ▶ Hold hose in a container of descaler (at least 10 litres).



Note:

Use only descalers that are suitable for domestic appliances. The descaler must not attack plastics and aluminium.

- ▶ Operate the 40-cup coffee machine without the filter holder and with the tank full or operate the 2-carafe filter system with two carafes.



Note:

Clean the filter holder of the 40-cup coffee machine using only a commercially available washing up liquid and a brush.

- ▶ Connect the hose to fresh water tank (4).

- ▶ Flush with fresh water. To do this, brew several carafes without coffee.

**Note:**

Repeat the last step until the water no longer tastes or smells of descaler or vinegar.

Winter operation

- ▶ Galley switched on
- ▶ Over winter, drain the fresh water tank, water lines, boiler, coffee machines and siphon.

**Note:**

To prevent damage to water-carrying installations, these must be completely drained before the first frost.

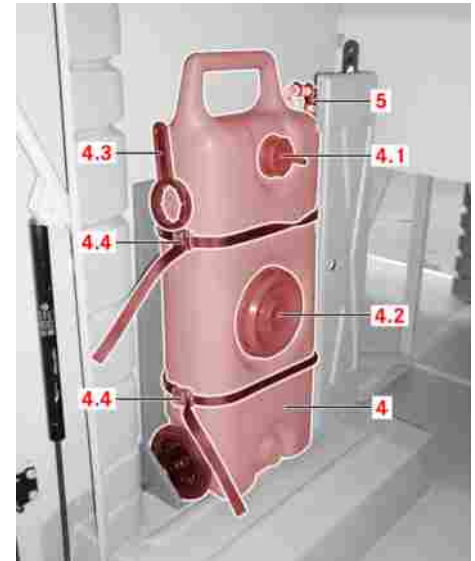
Draining the fresh water tank

M86_00-0142-02

- ▶ Disconnect quick-release coupling (5) from fresh water tank (4).

Draining the boiler

**Caution:**

There is a risk of overheating if the boiler is operated with no water. Switch off the boiler before draining it.

**Note:**

The drain plug is located on the bottom left behind the folding cover of the galley.

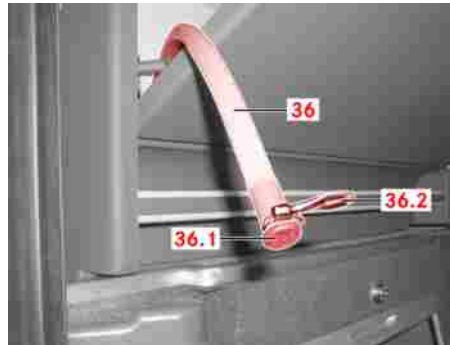

M86_00-0306-71

- ▶ Pull out hose (36) on the left-hand side behind the folding cover.
- ▶ Position a heat-resistant container (minimum capacity of 5 litres) under the end of the hose sealed with a red or black drain plug (36.1).

**Danger.**

Hot water may flow out when the boiler is drained. Do not allow your hands or arms to come into contact with the water.

- ▶ Open hose clamp (36.2), remove red or black drain plug (36.1) and drain all the water from the boiler into the container underneath.
- ▶ Seal hose (36) with the red or black drain plug (36.1). Secure drain plug (36.1) firmly in place using hose clamp (36.2). Slide hose (36) back into the galley.

The boiler is completely drained.

Draining the 40-cup coffee machine

Draining the 40-cup coffee machine



M86_00-0159-02

- ▶ Position residual drain valve (37) over drainage basin (38).

- ▶ Turn residual drain valve (24) to the open position to drain the residual water from the 40-cup coffee machine.

The residual water drains out.

- ▶ Turn residual drain valve (24) back to the closed position.

The 40-cup coffee machine is completely drained and sealed.

Draining the 2-carafe filter system



Note:

The 2-carafe filter system is automatically drained after every brewing process.

- ▶ Proceed as follows if you wish to make sure that there is no more water in the 2-carafe filter system:



M86_00-0151-01

- ▶ Place an empty carafe (26) on the left-hand side.



M86_00-0156-01

- ▶ Press button (33).

The water in the coffee machine tank is boiled out.

The 2-carafe filter system is drained.

Draining the siphon

i Note:

The siphon of the galley waste water drain is located in the 2nd step in doorway II.

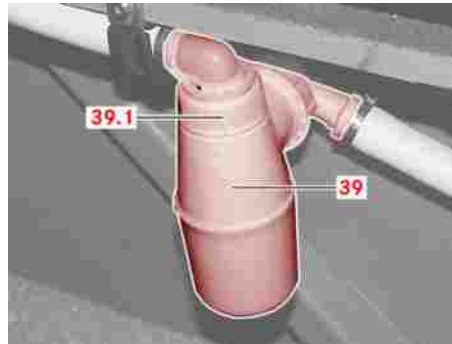

M86_00-0160-01

- ▶ Disassemble and empty the siphon (39) (odour trap) for the kitchenette waste water drain at union nuts (39.1).

- ▶ Fill the siphon with windscreen anti-freeze mat. no. A 001 986 45 71 11 (down to -30 °C) and then reassemble it.

Replacing fuses

Replacing fuses

 **Danger. Risk of fire.**

Do not use fuses with a higher than specified amperage.

The result would be damage to the electrical system or even a fire in the cables.

- Always use fuses of the specified amperage and never attempt to bridge or rewire fuses.
- Fuses should be replaced only when the cause of malfunction has been rectified.

 **Danger.**

Do not replace fuses unless the power has been switched off.

 **Note:**

This description is based on the standard assignment of fuses in the bus. Bus-specific assignment may differ from bus to bus. Not all fuse slots are necessarily occupied in every bus. Furthermore, fuses may occupy unassigned slots because they are protecting special customer options or retrofitted equipment, for example.



M86_00-0001-01

- ▶ Switch off the kitchenette at master switch (1).

The LED goes out.

- ▶ Switch off the engine.



M54.00-2004-71

- ▶ Switch battery isolating switch (01S01) to OFF.

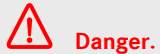
**Danger.**

Use only fuses of the specified amperage. Never replace fuses with those of a higher ampere rating as this could lead to damage to the electrical system.

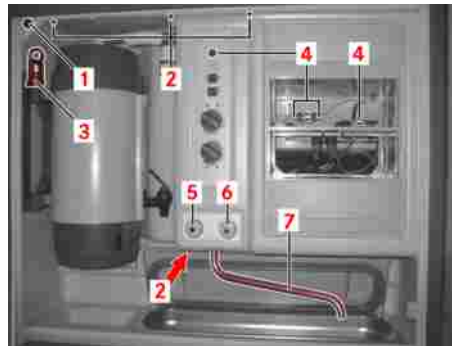

M86_00-0377-71

- ▶ One fuse (4) is integrated into the control panel. Additional fuses (4) are located behind the drawers.

**Note:**

In the case of on-board kitchenettes with 40-cup coffee machine.

- ▶ Remove the control panel by loosening the four crosshead screws under the film.

**Note:**

In the case of on-board kitchenettes with 2-carafe filter system.

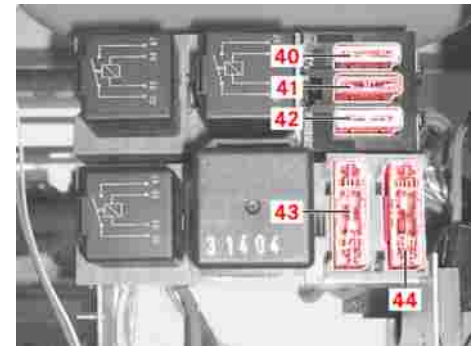

M86_00-0162-01

- ▶ Exchange the defective fuse.
- ▶ Move the control panel into position and secure using the four crosshead screws.

The kitchenette can be switched on.

Malfunctions

Malfunctions

- ▶ This section describes malfunctions that you can rectify yourself.

Restoring boiler operation following a malfunction

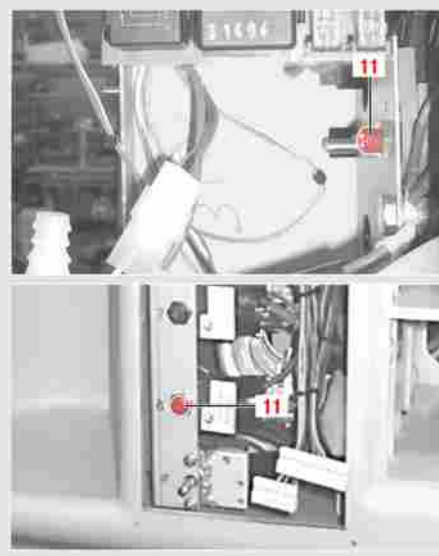

M86_00-0148-02

- ▶ The overheating protection is triggered if the boiler is operated with no water.



Note:

Fill the boiler with water to rectify the malfunction. Reactivate the overheating protection by pressing button (11) behind the control panel.

Using the sausage heater again after a malfunction

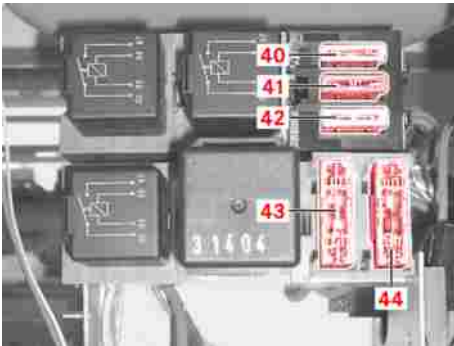

M86_00-0162-01

- ▶ The boiler does not heat up.

i **Note:**

Replace fuse (44) to rectify the malfunction.

- ▶ Insufficient hot water flow or excessive heating time.

i **Note:**

Symptom of scaling, descale the boiler.

- ▶ Water flows out of the tap when the boiler is heating.

i **Note:**

No malfunction, because water expands during the heating process.

Using the sausage heater again after a malfunction

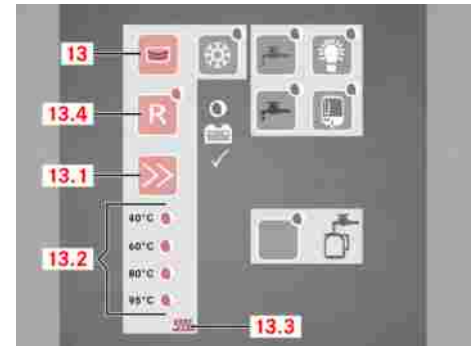

M86_00-0165-01

- ▶ The overheating protection is triggered if the sausage heater is operated with no water. The red LED in button (13.4) lights up.

i **Note:**

Fill the sausage heater with water to rectify the malfunction. Reactivate the overheating protection by pressing button (13.4) on the control panel.

Using the 40-cup coffee machine again after a malfunction

Using the 40-cup coffee machine again after a malfunction

- ▶ Heating is switched off by a temperature limiter if the coffee machine overheats.

i Note:

Pressing in the red pin at the base of the appliance reactivates the coffee machine (after approximately 5 - 10 minutes cooling down period)

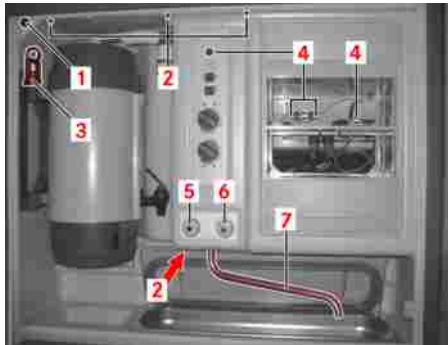

M86_00-0377-71

- ▶ The indicator lamp does not light up.

i Note:

Check the power supply or replace fuse (4) if necessary.

- ▶ The brewing process for 40 cups still has not finished after approximately 40 minutes.

i Note:

The riser pipe is not seated in the centre of the brewing chamber. Riser pipe or diaphragm blocked.

- ▶ Coffee machine boils over.

i Note:

Too much water added. Coffee powder too fine. Filter holder clogged or blocked. Lid not locked.

- ▶ Dripping tap.

i Note:

Dirt, e.g. coffee residue, clean the tap. Screw connection leaking, replace the seal.

Using the 2-carafe filter system again after a malfunction

- ▶ No water level in the water level glass even though the coffee machine is full.

i **Note:**

Lower inlet opening blocked. Clean the inlet opening from the inside, remove the water level glass if necessary.

- ▶ Water dripping from residual drain valve.

i **Note:**

Dirt, e.g. coffee residue, unscrew the angle piece and clean the tap. Screw connection leaking, replace the seal.

Using the 2-carafe filter system again after a malfunction

- ▶ A continuous tone indicates that the fresh water tank is empty.

i **Note:**

Fill the fresh water tank. Press any button on the control panel of the 2-carafe filter system. The 2-carafe filter system resumes the program from the point at which it was interrupted.

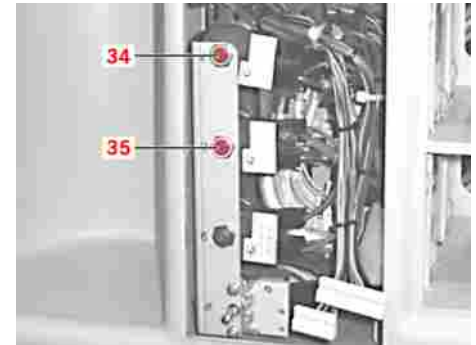

M86_00-0157-01

- ▶ Overheating protection triggered.

i **Note:**

To reactivate the 2-carafe filter system, press the overheat protection switch for left-hand carafe (34) or right-hand carafe (35) behind the control panel.

Other malfunctions

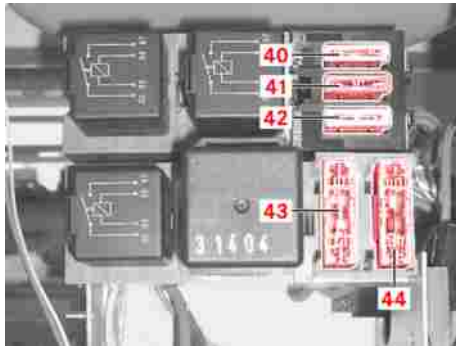

M86_00-0162-01

- ▶ 2-carafe filter system fills with water but does not brew.



Note:

Replace fuse (43) to rectify the malfunction.

Other malfunctions

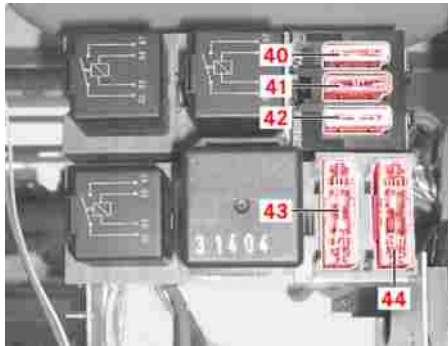

M86_00-0162-01

- ▶ The control panel is not working.



Note:

Either the fuse or the control panel is defective. Replace fuse (42) or have the control panel repaired by the after-sales service.

- ▶ Galley light does not switch on.



Note:

Change bulb (24 V/5 W) or replace fuse (42).



Note:

In the case of on-board kitchenettes with 40-cup coffee machine, the lighting features LED technology.

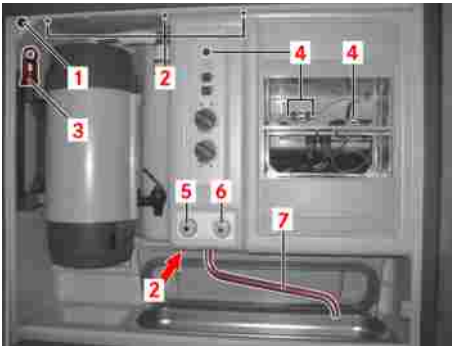

M86_00-0377-71

- ▶ No water or irregular flow.

i Note:

Fill the fresh water tank with water. Or replace fuse (41). Or have the water pump replaced by the after-sales service.

i Note:

In the case of on-board kitchenettes with 40-cup coffee machine, replace defective fuse (4).

Switching off the galley

i Note:

All appliances must be switched off before the galley can be switched off.

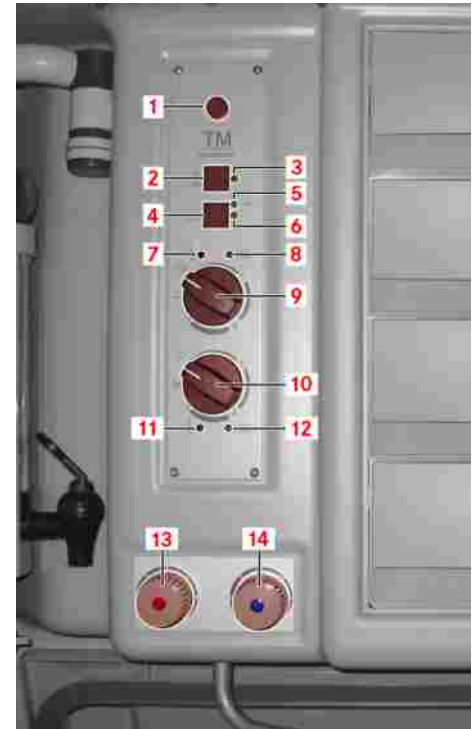

M86_00-0375-73

General information	308
Use for the intended purpose	309
Approved personnel	309
Switching on the on-board kitchenette (Eltesan)	309
Drawing water from the tap (Eltesan)	311
Filling with fresh water (Eltesan)	312
Troubleshooting (Eltesan)	314
Winter operation (Eltesan)	315

General information

General information



Caution:

Never operate the equipment without water. Risk of thermal damage - loss of warranty.



Danger.

To avoid the risk of fire and damage, it is prohibited to store anything inside the sausage heater or microwave oven.



Danger.

Use only clean drinking water.



Danger.

To prevent the growth of microbes in water left inside the system, the entire system must be drained (refer to "Winter operation") if the galley and/or lavatory is to remain out of service temporarily.



Note:

It is advisable to disinfect water-carrying systems at regular intervals or after operation has been restored. A sodium hypochloride solution (from camping and caravanning retailers) is particularly suitable; observe the manufacturer's instructions.



Caution:

Do not use the coffee machine, water boiler or sausage heater unless the kitchenette is open. Damage caused by heat and steam when the kitchenette is closed is not covered by the warranty.



Danger.

Secure loose objects in the kitchenette (cans, cups, lids, etc.) properly during the journey.



Note:

Waste water from the galley flows into the lavatory's holding tank.



Environmental protection

Dispose of waste in an environmentally responsible manner. The rules and regulations of the country in which the vehicle is operated must be observed.

Use for the intended purpose

Use for the intended purpose

The galley and its equipment are intended for normal kitchen use during a bus journey. This includes:

- Boiler for hot water preparation
- Coffee machine for brewing coffee
- Sausage heater for preparing sausages

Any other use cannot be considered use for the intended purpose.

Approved personnel

The kitchenette may only be used by trained personnel. The personnel must be professionally qualified and have read and understood this section.

The safety of the person using the kitchenette and the security of all kitchen utensils are prerequisites for use of the kitchenette while the bus is in motion.



Danger.

Objects being thrown out of the kitchenette can cause injuries. The person using the kitchenette must secure loose objects safely while the bus is in motion.

Switching on the on-board kitchenette (Eltesan)



Note:

The kitchenette is ready for operation when switch (1) on the instrument panel is switched on and the ignition switch is in position 1.



M86_00-0001-01

- ▶ Turn the ignition switch to position 1 and press on-board kitchenette main switch (1).

Switching on the on-board kitchenette (Eltesan)

**Note:**

The water boiler cannot be operated unless the engine is running.

**Caution:**

Never use the equipment without water. Risk of thermal damage - loss of warranty. Only use clean drinking water.

**Danger.**

To prevent the growth of microbes in the residual water in the system, the entire system must be drained (refer to “Winter operation”) if the galley and/or lavatory is out of service for any short period of time.

**Note:**

It is advisable to disinfect water-carrying systems at regular intervals or after operation has been restored. A sodium hypochloride solution (from camping and caravanning retailers) is particularly suitable; observe the manufacturer's instructions.

**Caution:**

Do not operate the water boiler unless the kitchenette is open. Damage caused by heat and steam when the kitchenette is closed is not covered by the warranty.

**Caution:**

Secure loose objects in the kitchenette (cans, cups, lids, etc.) properly during the journey.

**Note:**

Clean all the equipment thoroughly with water and washing up liquid before using it for the first time.

Drawing water from the tap (Eltesan)

i **Note:**

The kitchenette must have been switched on at the switch in the driver's area. The fresh water supply tank must also contain water and be connected.

i **Note:**

The water boiler cannot be operated unless the engine is running.

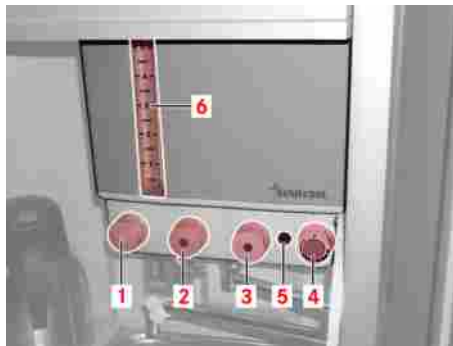

M86_00-0131-01

- ▶ Hot water can be drawn from the boiler at tap (2) provided the boiler contains water. Draw off cold water directly from the storage tank using tap (3).



Danger.

Outflow of hot water - danger of scalding.

- ▶ By opening tap (1), you can fill the hot water boiler with fresh water up to the maximum level (observe scale (6)).

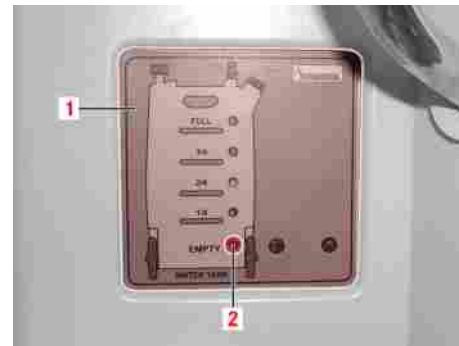

M86_00-0307-71

The water level in the fresh water supply tank has dropped to the minimum level if red LED (2) on level gauge (1) lights up. Fill up the supply tank at the earliest opportunity.

- ▶ Switch on the boiler heating by turning control knob (4) and pressing the red pushbutton.

Filling with fresh water (Eltesan)



Caution:

Before you switch on the heating, make sure that the hot water boiler contains water (minimum 0.5 litres).



Note:

Lamp (5) lights up while the heating is switched on.



Note:

Heating power (and thus water temperature and heating time) is continuously adjustable using control knob (4).



Note:

Lamp (5) goes out when the set temperature has been reached. If the water cools down, it is necessary to press the red pushbutton once more to recommence heating.



Note:

To avoid scale and steam, do not turn the control knob to the "MAX" position unless you need very hot water or would prefer the water to heat up within a short period of time. For normal use, it is satisfactory to set the temperature to approximately 3/4 of the "MAX" value.



Caution:

Turning the control knob too far could damage it beyond repair.

Filling with fresh water (Eltesan)

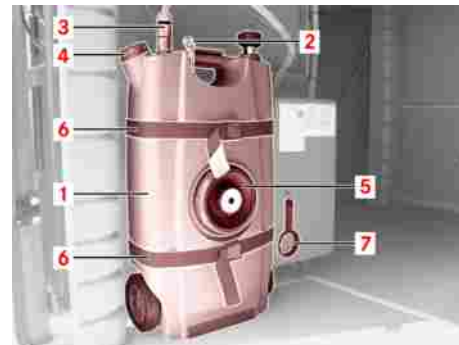

M86_00-0308-71

- Either fill storage tank (1) inside the bus at cap (4) or remove the tank from the bus (by loosening tensioning straps (6), releasing quick-release coupling (3) and removing split pin (2)) and fill at cap (5).

Filling with fresh water (Eltesan)

**Danger.**

The tools used to fill with water (containers, funnels, hoses, etc.) must be sterile.

**Note:**

It is recommended that fresh water tank (1) be cleaned manually via caps (4) and (5) and/or that it be flushed thoroughly with fresh water. The fresh water lines should then also be flushed with fresh water by drawing cold/hot water.

**Note:**

Use spanner (7) if the caps are difficult to turn.

**Note:**

The fresh water supply tank is located in the luggage compartment to the front of the lavatory.

- ▶ Refit the supply tank, secure with tensioning straps (6), reinsert split pin (2) and connect quick-release coupling (3).

**Danger.**

The kitchenette must be operated using clean and potable water only. The fresh water for the kitchenette must be renewed daily. If the fresh water is stored in the water tank for a long period of time, an additive (Micropur, part number 0.971.407.000) in accordance with the manufacturer's instructions must be mixed with it.

**Note:**

In new buses, the drinking water may sometimes taste of plastic. An additive (Kunststoff-Frisch, Mat. No. 0.971.405.000) can be mixed in accordance with the manufacturer's instructions to neutralise this aftertaste.

**Note:**

Waste water from the kitchenette flows into the lavatory's holding tank.

Troubleshooting (Eltesan)

Troubleshooting (Eltesan)



Note:

The kitchenette must have been switched on at the switch in the driver's area. The fresh water supply tank must also contain water and be connected.

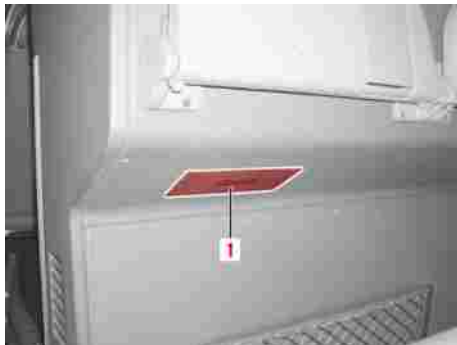

M86_00-0135-01

- ▶ Check the fuses in the event of an on-board kitchenette failure or malfunction.



Note:

These are accessible at the back of the on-board kitchenette if the cover secured by 2 screws is removed.



Danger.

Make sure that you correct the cause of the short circuit before you change a blown fuse. Check that the connections have a good contact.



Danger.

Never attempt to bridge or repair fuses.



Danger.

Use only fuses of the specified amperage. Never replace fuses with those of a higher ampere rating as this could lead to damage to the electrical system.



Danger.

Switch off the battery isolating switch (01S01) on the auxiliary switch panel before carrying out work on the electrical system.

Winter operation (Eltesan)

- ▶ Remove and drain the fresh water supply tank.



Note:

To prevent damage to water-carrying installations, these must be completely drained before the first frost.

Safety precautions/general information	319
Use for the intended purpose	320
Approved personnel	320
First use of the kitchenette	320
Switching on the kitchenette	321
Filling the fresh water tank inside the bus	323
Filling the fresh water tank outside the bus	324
Checking and cleaning the fresh water filter	324
Drawing water from the water tap	325
Switching on the sausage heater	325
Cleaning the sausage heater	328
Descaling the sausage heater	328
Switching on the coffee machine	329
Brewing 1/2 a carafe of coffee (10 cups of coffee)	329
Brewing 1 carafe of coffee (20 cups of coffee)	330
Descaling the coffee machine	331

Table of contents

Dispensing cups of hot water (alternative to coffee machine)	332
Boiler (option)	333
Setting the thermostat of the water heater	334
Descaling the water heater boiler	335
Winter operation	336
Draining the fresh water tank	337
Draining the water lines	337
Draining the boiler	338
Draining the siphon	339
Replacing fuses	339
Malfunctions	342
Using the sausage heater again after a malfunction	342
Using the coffee machine again after a malfunction	343
Using the boiler (option) again after a malfunction	344
Other malfunctions	345
Switching off the galley	346

Safety precautions/general information



Caution:

Never operate the equipment without water. Risk of thermal damage - loss of warranty.



Caution:

Do not use the coffee machine or sausage heater unless the kitchenette is open. Damage caused by heat and steam when the kitchenette is closed is not covered by the warranty.



Danger.

To avoid the risk of fire and damage, it is prohibited to store anything inside the sausage heater or microwave oven.



Danger.

Secure loose objects in the kitchenette (cans, cups, lids, etc.) properly during the journey.



Danger.

Use only clean drinking water.



Danger.

To prevent the growth of microbes in water left inside the system, the entire system must be drained (refer to "Winter operation") if the kitchenette and/or lavatory is to remain out of service temporarily.



Note:

It is advisable to disinfect water-carrying systems at regular intervals or after operation has been restored. A sodium hypochloride solution (from camping and caravanning retailers) is particularly suitable; observe the manufacturer's instructions.



Note:

Waste water from the kitchenette flows into the lavatory's holding tank.



Environmental protection

Dispose of waste in an environmentally responsible manner. The rules and regulations of the country in which the vehicle is operated must be observed.

Use for the intended purpose

Use for the intended purpose

The kitchenette and its equipment are intended for normal kitchen use during a bus journey. This includes:

- Sausage heater for preparing sausages
- Coffee machine for brewing coffee
- Boiler (option) for dispensing cups of hot water

Any other use cannot be considered use for the intended purpose.

Approved personnel

The galley may only be used by trained personnel. The personnel must be professionally qualified and have read and understood this section.

The safety of the person using the kitchenette and the security of all kitchen utensils are prerequisites for use of the kitchenette while the bus is in motion.



Danger.

Objects being thrown out of the kitchenette can cause injuries. The person using the kitchenette must secure loose objects safely while the bus is in motion.

First use of the kitchenette

- ▶ Kitchenette switched on
- ▶ Fresh water tank filled and connected
- ▶ All packaging materials must be removed before the kitchenette is used for the first time.



Environmental protection

Dispose of the packaging material in an environmentally responsible manner.

- ▶ Before first use, clean the sausage heater tank, the lid and the overflow pipe thoroughly with hot water and a commercially available washing-up liquid, and then rinse well with clean water. Then wipe the sausage heater tank dry to avoid scaling.
- ▶ To clean the coffee machine, fill it with water and brew the water without coffee powder but with the filter fitted, then repeat.

Switching on the kitchenette

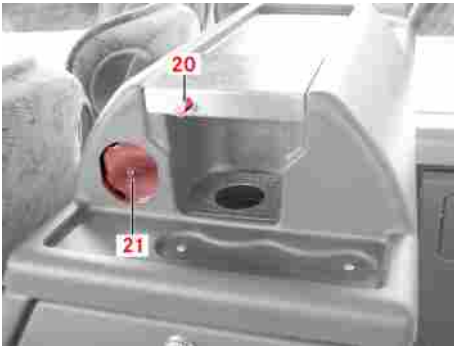

M86_00-0178-71

- ▶ Before the boiler (option) is switched on, its tank must be filled with water.

i Note:

Switch on the boiler using the kitchenette master switch on the instrument panel. Do not start the engine, otherwise the boiler will begin to heat. Press and hold hot water dispensing button (20) until water flows out of the dispenser with no air (it takes approximately 2 minutes for the boiler to fill). It is advisable to flush the boiler with fresh water. To do this, draw approximately 2 to 3 litres of hot water. Start the engine to heat the boiler

(length of the heating phase approximately 5 minutes).

i Note:

Fill cup dispenser (21) from the front with cups, approximately 100 cups.

The kitchenette is ready for use.

Switching on the kitchenette

i Note:

The coffee machine, sausage heater and boiler (option) cannot be operated unless the engine is running.



M68_00-0168-71

- ▶ Press kitchenette master switch (18).

A buzzer sounds in the kitchenette electronics. The LED in master switch (18) lights up.

Switching on the kitchenette

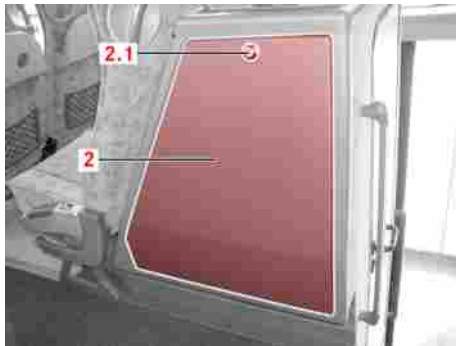

M86_00-0169-71

- ▶ Release cover (2) on lock (2.1) by unlocking and removing it.



Note:

Stow the kitchenette cover safely.



M86_00-0170-71

- ▶ Switch on the kitchenette lighting using button (3) on the kitchenette control panel.

The kitchenette lighting on the left above the washbasin comes on. The LED in button (3) on the control panel lights up.

The kitchenette is open and ready for use.



Note:

If battery (1) does not light up in green on the control panel, there is insufficient on-board voltage to operate the kitchenette. Start the engine to enable the batteries to recharge.

Filling the fresh water tank inside the bus

Filling the fresh water tank inside the bus



M86_00-0142-02

- Fill fresh water tank (4) via cap (4.1).

Danger.

The kitchenette must be operated using clean and potable water only. Fresh water for kitchenette requirements must be renewed every day. If the fresh water is stored in the water tank for a long period of time, an additive (Micropur, mat. no. 0.971.407.000) in accordance with the manufacturer's instructions must be mixed with it.

Danger.

The tools used to fill with water (containers, funnels, hoses, etc.) must be sterile.

Note:

It is recommended that fresh water tank (4) be cleaned manually via caps (4.1) and (4.2) and/or that it be flushed thoroughly with fresh water. The fresh water lines should then also be flushed with fresh water by drawing cold/hot water and switching on the coffee machine.

Note:

Use spanner (4.3) if the caps are difficult to turn.

Note:

In new buses, the drinking water may sometimes taste of plastic. An additive (Kunststoff-Frisch, mat. no. 0.971.405.000) can be mixed in accordance with the manufacturer's instructions to neutralise this aftertaste.

Note:

Waste water from the kitchenette flows into the lavatory's holding tank.

Filling the fresh water tank outside the bus

Filling the fresh water tank outside the bus

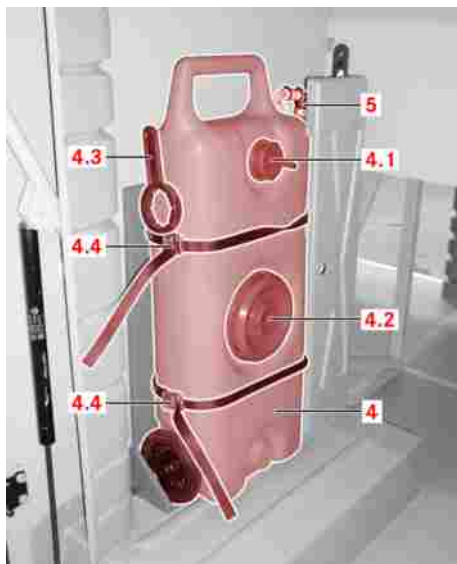

M86_00-0142-02

- ▶ Disconnect quick-release coupling (5) from fresh water tank (4).

- ▶ Release tensioning straps (4.4). Remove fresh water tank (4).
- ▶ Fill fresh water tank (4) with pure drinking water via cap (4.2). Close cap (4.2) firm and tight.
- ▶ Fit fresh water tank (4) into the bus and secure using tensioning straps (4.4).
- ▶ Connect quick-release coupling (5) to fresh water tank (4).

Checking and cleaning the fresh water filter

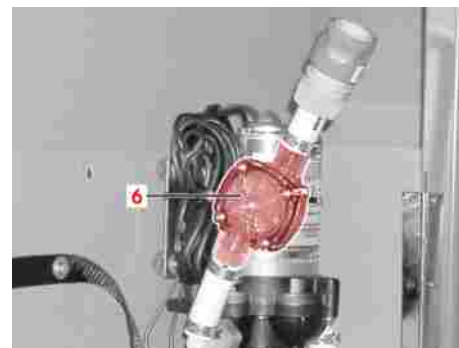

M86_00-0143-01

- ▶ Check fresh water filter (6) for clogging at regular intervals (depending on the water quality) and clean it if necessary.



Note:

The fresh water filter is located between the fresh water tank and the fresh water pump.

Drawing water from the water tap

Drawing water from the water tap

- ▶ Galley switched on
- ▶ Fresh water tank filled and connected



M86_00-0171-71

- ▶ Press button (7) to draw cold water from tap (8).

Cold water continues to flow while button (7) is pressed.



Note:

Tap (8) can be pulled out by approximately 20 cm.

Switching on the sausage heater

- ▶ Galley switched on
- ▶ Fresh water tank filled and connected



Danger.

There is a risk of scalding when using the sausage heater. Hot steam can rise, which may cause serious burns to the face, arms and hands. Keep at a safe distance, and remove hot sausages using only heat-resistant kitchen utensils.



Note:

The heating up time depends on the amount of water, the number of sausages and the temperature of the water used to fill the boiler.

Switching on the sausage heater



Note:

The sausage heater has a capacity of 5 litres.



Note:

Waste water from the galley flows into the lavatory's holding tank.



M86_00-0336-71

- ▶ Insert overflow pipe (1) into the discharge hole, ensuring leak-tightness.



Danger.

Never use the sausage heater without water.



Note:

Excess water may run out via overflow pipe (1).

- ▶ Fill the sausage heater tank with approximately 4 cm cold or hot water.
- ▶ Add the sausages to the sausage heater tank and replace the lid on the sausage heater tank.



Note:

When adding sausages, there is a risk of hot water splashing and causing burns to the face, arms and hands. Add the sausages to the water carefully and keep a safe distance.

Switching on the sausage heater

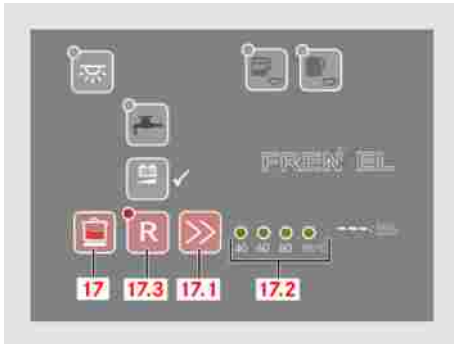

M86_00-0337-71

- ▶ Switch on the sausage heater using button (17) on the control panel.

One of LEDs (17.2) flashes or lights up.

i Note:

Pressing button (17) again switches off the sausage heater. LED (17.2) goes out.

- ▶ Press button (17.1) repeatedly until the desired temperature is set.

i Note:

It is possible to set a temperature of 40, 60, 80 or 95 °C. LED (17.2) indicates the set temperature.

i Note:

LED (17.2) flashes while the sausage heater is heating and lights up when the set temperature has been reached.



M86_00-0336-71

- ▶ Remove the lid when the sausages are heated.

! Danger.

The sausage heater is hot and generates steam - risk of scalding. Do not remove overflow pipe (1) until the water in the tank has cooled sufficiently that there is no longer a risk of scalding.

- ▶ Take out the sausages using tongs or a suitable, heat-resistant kitchen utensil.

Cleaning the sausage heater



M86_00-0336-71

- ▶ The water in the sausage heater tank can be drained as soon as the water has been allowed to cool down. To do this, remove overflow pipe (1) from the discharge hole.

Cleaning the sausage heater

- ▶ After use, clean the sausage heater tank, the lid and the overflow pipe with warm water and a commercially available washing up liquid. Use a soft sponge without a scourer or similar abrasive product. Rinse with clean water and wipe the sausage heater tank dry to avoid scaling. Clean the overflow pipe with bottle cleaner at regular intervals.



Note:

Clean the sausage heater tank with a commercially available stainless steel cleaner at regular intervals.

Descaling the sausage heater

- ▶ Fill the sausage heater tank 2 cm high with descaler.
- ▶ Leave the descaler to work (observe the information issued by the manufacturer).



Note:

For heavy scaling, it is possible to operate the sausage heater containing descaler for approximately 30 minutes at 80 °C.

- ▶ Drain the boiler after the descaler reaction time and rinse well with clean water. Wipe the sausage heater tank dry.

Switching on the coffee machine

Switching on the coffee machine

- ▶ Kitchenette switched on
- ▶ Fresh water tank filled and connected



Caution:

Running programs cannot be paused. If there is a power failure, it will be necessary to restart the program. If the carafe contains coffee from a previous program, it must be drained first to avoid the risk of overflowing.



Caution:

To avoid the risk of overflowing, make sure that the carafe is empty before the brewing process begins.



Note:

The coffee filter must equate to size 1 x 6 (commercially available). Add the amount of coffee powder according to taste (e.g. 1 teaspoon per cup).

- ▶ The coffee machine can be used to fill a vacuum carafe with a capacity of 2 litres. This is sufficient to pour 20 100 ml cups of coffee. It is possible to brew 1/2 a carafe or 1 carafe of coffee.

Brewing 1/2 a carafe of coffee (10 cups of coffee)



M86_00-0173-71

- ▶ Remove filter (11) from the filter holder. Insert filter paper and add as much coffee powder as required.



Note:

Judge the amount of coffee powder according to taste (e.g. 1 teaspoon per cup).

Brewing 1 carafe of coffee (20 cups of coffee)

- ▶ Slide filter (11) back into the filter holder.
- ▶ Place an empty carafe (12) under filter (11).

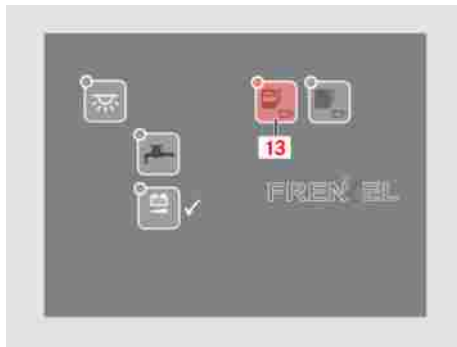

M86_00-0174-71

- ▶ Press button (13) on the control panel.
The LED in button (13) lights up. The brewing process begins.
- ▶ An electronic signal sounds when brewing has finished.
The LED in button (13) goes out.

Brewing 1 carafe of coffee (20 cups of coffee)



M86_00-0173-71

- ▶ Remove filter (11) from the filter holder. Insert filter paper and add as much coffee powder as required.



Note:

Judge the amount of coffee powder according to taste (e.g. 1 teaspoon per cup).

- ▶ Slide filter (11) back into the filter holder.
- ▶ Place an empty carafe (12) under filter (11).



M86_00-0175-71

- ▶ Press button (14) on the control panel.
The LED in button (14) lights up. The brewing process begins.
- ▶ An electronic signal sounds when brewing has finished.
The LED in button (14) goes out.

Descaling the coffee machine

Descaling the coffee machine



Note:

How frequently the coffee machine should be descaled depends on the water quality but the coffee machine should be descaled immediately if performance deteriorates or if the openings in the spray head (above the filter) begin to scale up.



M86_00-0142-02

- ▶ Disconnect the hose at quick-release coupling (5).

- ▶ Hold the hose in a container of descaler.



Note:

Use only descalers that are suitable for domestic appliances. The descaler must not attack plastics and aluminium.

- ▶ Operate the coffee machine with an amount of water sufficient to fill one carafe.
- ▶ Connect the hose to fresh water tank (4).
- ▶ Flush with fresh water. To do this, brew several carafes without coffee.



Note:

Repeat the last step until the water no longer tastes or smells of descaler or vinegar.

Dispensing cups of hot water (alternative to coffee machine)

Dispensing cups of hot water (alternative to coffee machine)



Note:

The kitchenette is also able to dispense cups of hot water as an alternative if there is no filter (11) in the filter holder. The electronics detect this condition automatically and dispense cups of hot water when the button is pressed.



Caution:

There is a risk of scalding when dispensing hot water. There is a possibility of hot steam rising, which could result in severe scalding of the face, arms and hands. Do not dispense hot water unless it is safe to do so.



M86_00-0173-71

- ▶ Remove filter (11) from the filter holder and remove vacuum carafe (12).

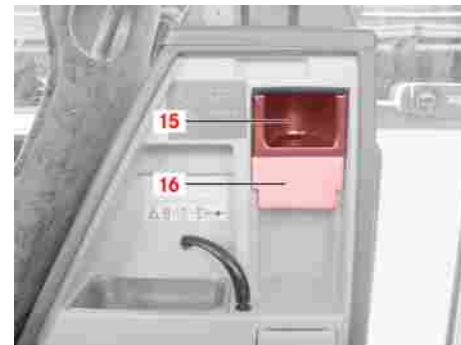

M86_00-0177-71

- ▶ To ensure stability of the cups, fit cup holder supplied (15) into the filter holder. Place cup dispenser supplied (16) with cups underneath.
- ▶ Remove the cup from cup dispenser (16) and place it in cup holder (15) under the opening of the spray head.

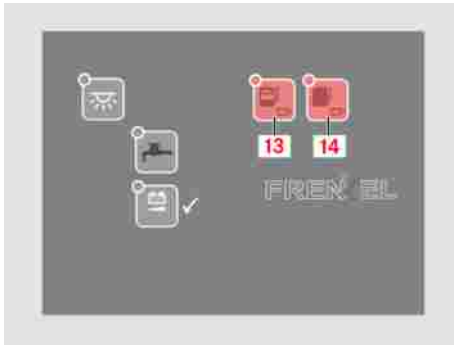

M86_00-0176-71

- ▶ To dispense hot water into a cup, press button (13) or (14) on the control panel.

One press of button (13) or (14) dispenses one cup of hot water.

Boiler (option)

- ▶ Kitchenette switched on
- ▶ Fresh water tank filled and connected
- ▶ Boiler filled



Caution:

There is a risk of overheating and thermal damage if the boiler is operated with no water. Never operate the boiler without water.

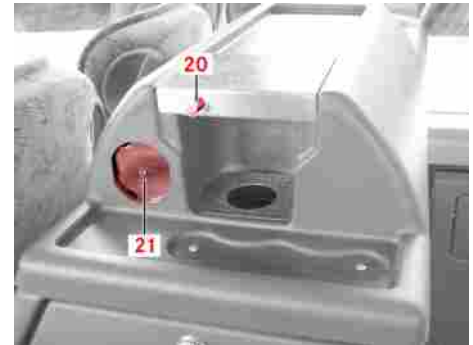

M86_00-0178-71

- ▶ To make sure that the boiler contains water, press and hold hot water dispensing button (20) before starting the engine until water flows out of the dispenser.

The boiler has been filled with water and bled.

Setting the thermostat of the water heater

- ▶ The boiler cannot be switched on unless the engine is started first.



Note:

The length of the heating phase is approximately 5 minutes.

- ▶ Remove the cup from cup dispenser (21) and place it under the water dispenser.



Note:

It is possible to insert approximately 100 cups into the cup dispenser from the front.

- ▶ To dispense hot water into a cup, press hot water dispensing button (20).



Caution:

Outflow of hot water - risk of scalding.

Hot water continues to flow while hot water dispensing button (20) is pressed.

Setting the thermostat of the water heater

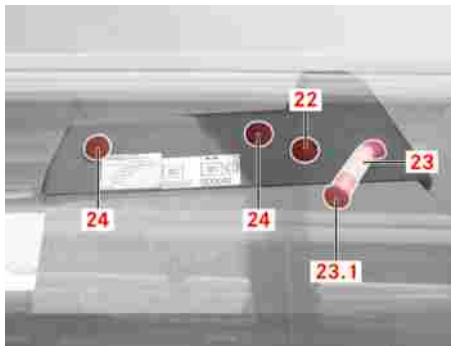

M86_00-0179-71

- ▶ To set the thermostat, remove cap (22) and turn the thermostat.



Note:

The boiler thermostat is located on the back of the water heater.



Note:

To set a lower temperature for the boiler, turn the thermostat anti-clockwise.



Note:

To set a higher temperature for the boiler, turn the thermostat clockwise.

Descaling the water heater boiler

Descaling the water heater boiler

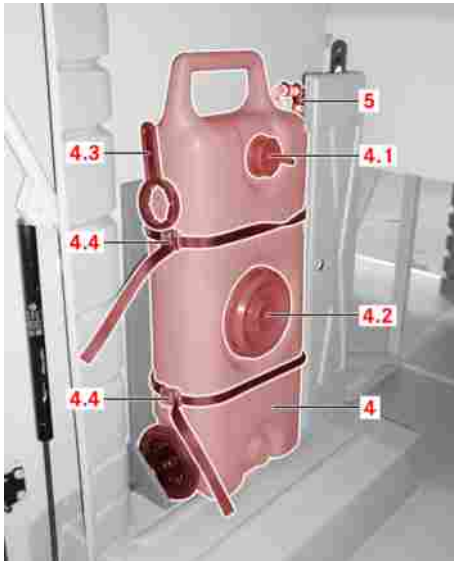

M86_00-0142-02

- ▶ Disconnect the hose at quick-release coupling (5).

i **Note:**

How frequently the boiler should be descaled depends on the water quality but the boiler should be descaled immediately if the heating time is noticeably longer or if the openings in the water dispenser begin to scale up.

- ▶ Hold the hose in a container of descaler (at least 2 litres).

i **Note:**

Use only descalers that are suitable for domestic appliances. The descaler must not attack plastics and aluminium. Observe the information provided by the manufacturer.

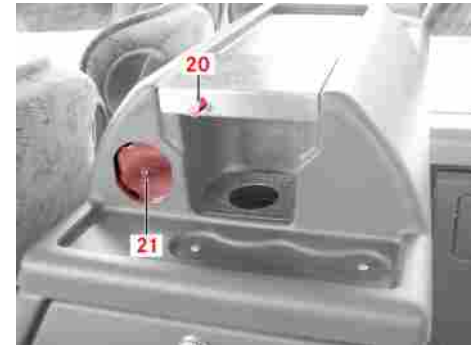

M86_00-0178-71

- ▶ Place a cup under the water dispenser and press hot water dispensing button (20) until the boiler draws at least 1.5 litres of water.

The boiler is filled with descaler. Observe the manufacturer's instructions on how long to leave the descaler to work.

Winter operation



M86_00-0142-02

- ▶ Connect the hose to fresh water tank (4).

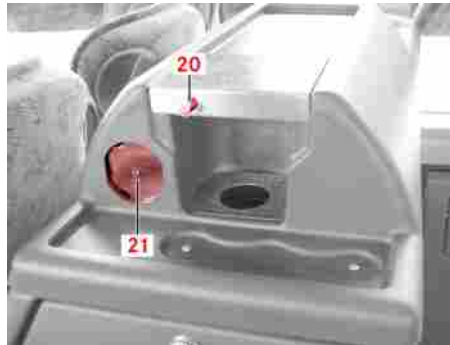

M86_00-0178-71

- ▶ Flush the boiler with plenty of fresh water. To do this, fill the boiler with fresh water using hot water dispensing button (20) and drain it.

i Note:

Repeat the last step until the water no longer tastes or smells of descaler or vinegar.

Winter operation

- ▶ Galley switched on
- ▶ Over winter, drain the fresh water tank, water lines, water heater boiler (option) and siphon.

i Note:

To prevent damage to water-carrying installations, these must be completely drained before the first frost.

Draining the fresh water tank

Draining the fresh water tank



M86_00-0142-02

- ▶ Disconnect quick-release coupling (5) from fresh water tank (4).

- ▶ Release both tensioning straps (4.4).
- ▶ Remove fresh water tank (4) from the bus and open cap (4.1) to completely drain the water.

i Note:

Use spanner (4.3) if the caps are difficult to turn.

- ▶ Close cap (4.1) firm and tight. Fit fresh water tank (4) into the bus and secure using tensioning straps (4.4). Connect quick-release coupling (5) to fresh water tank (4).

The fresh water tank is completely drained.

Draining the water lines

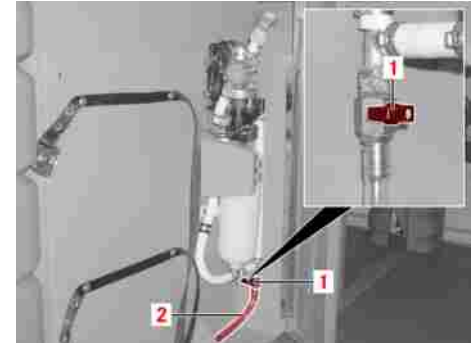

M86_00-0305-71

- ▶ To drain off the majority of the water, route hose (2) to the outside of the bus and open tap (1).

i Note:

The tap is located in the luggage compartment next to the fresh water tank or below the water pump.

- ▶ To drain off the remaining water, force water through the cold water line using the control panel and run it empty.

Draining the boiler



M86_00-0171-71

- ▶ Press and hold button (7) until no more water flows out of tap (8).

The water lines are completely drained.

Draining the boiler



Caution:

There is a risk of overheating if the boiler is operated with no water. Do not start the engine while the boiler is being drained.

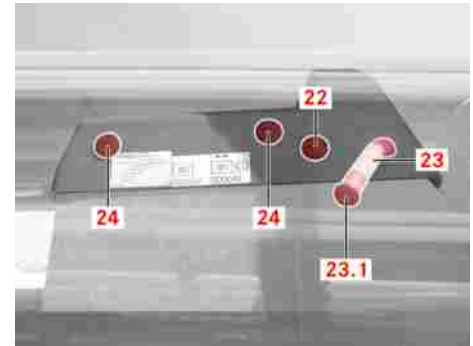

M86_00-0179-71

- ▶ Pull out winter drain hose (23).



Note:

Winter drain hose (23) is located on the back of the boiler.

- ▶ Position a heat-resistant container (minimum capacity of 2 litres) under the end of the hose sealed with a drain plug (23.1).



Danger.

Hot water may flow out when the boiler is drained. Do not allow your hands or arms to come into contact with the water.

- ▶ Remove drain plug (23.1) and completely drain the water from the boiler into the container underneath.
- ▶ Seal hose (23) with drain plug (23.1) and slide it back.

The boiler is completely drained.

Draining the siphon



Note:

The siphon is located under the washbasin in the lavatory.

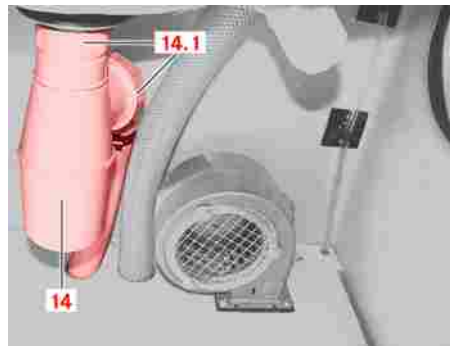

M86_00-0039-01

- ▶ Dismantle siphon (14) of kitchenette waste water drain at union nuts (14.1) and empty.
- ▶ Fill the siphon with windscreen anti-freeze mat. no. A 001 986 45 71 11 (down to -30 °C) and then reassemble it.

Replacing fuses



Danger. Risk of fire.

Do not use fuses with a higher than specified amperage.

The result would be damage to the electrical system or even a fire in the cables.

- Always use fuses of the specified amperage and never attempt to bridge or rewire fuses.
- Fuses should be replaced only when the cause of malfunction has been rectified.



Danger.

Do not replace fuses unless the power has been switched off.

Replacing fuses



Note:

This description is based on the standard assignment of fuses in the bus. Bus-specific assignment may differ from bus to bus. Not all fuse slots are necessarily occupied in every bus. Furthermore, fuses may occupy unassigned slots because they are protecting special customer options or retrofitted equipment, for example.



M68_00-0168-71

- ▶ Switch off the kitchenette at master switch (18).

The LED goes out.

- ▶ Switch off the engine.

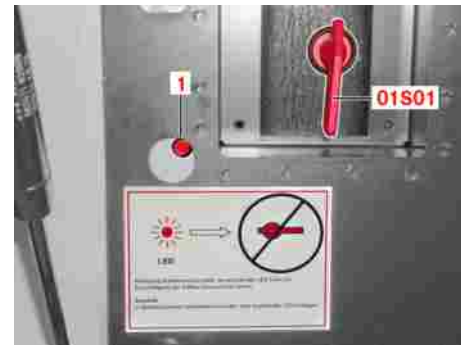

M54.00-2004-71

- ▶ Switch battery isolating switch (01S01) to OFF.



Danger.

Do not switch the battery isolating switch to OFF if the LED is lit (OM 470) only. Otherwise, the exhaust gas aftertreatment system could be damaged. Observe the instruction label.



Danger.

Use only fuses of the specified amperage. Never replace fuses with those of a higher ampere rating as this could lead to damage to the electrical system.

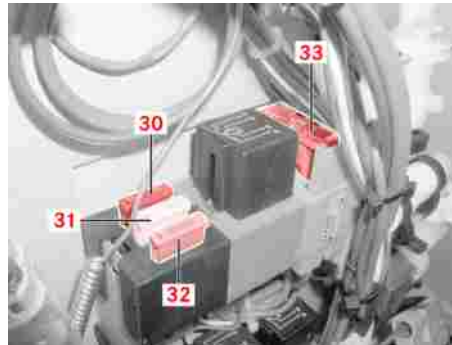

M86_00-0180-71

- ▶ Exchange the defective kitchenette fuse.



Note:

The fuses for the kitchenette are located on the back of the kitchenette behind the mirror in the lavatory. The mirror can be removed (screws, mirror bracket or Velcro fasteners).

- 30 - Water pump (10 A)
- 31 - Sausage heater (25 A)
- 32 - Electronics (5 A)
- 33 - Coffee machine (40 A)



M86_00-0181-71

- ▶ Exchange the defective boiler fuse.



Note:

The fuses for the boiler are located under the plastic cover. To remove the plastic cover, undo the two screws in the cup recesses and the screw in the carafe recess. Lift the back of the plastic cover approximately 5 cm and slide it forwards to free the plastic cover from the pipe of the cup dispenser.

- 34 - Terminal 15 (5 A)
- 35 - D+ (engine) (5 A)
- 36 - Water pump (10 A)

Malfunctions

37 - Boiler (50 A)

Malfunctions

- ▶ This section describes malfunctions that you can rectify yourself.

Using the sausage heater again after a malfunction

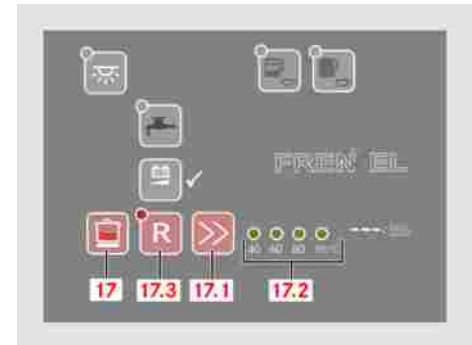

M86_00-0337-71

- ▶ The overheating protection is triggered if the sausage heater is operated with no water. The red LED in button (17.3) lights up.



Note:

Fill the sausage heater with water to rectify the malfunction. Reactivate the overheating protection by pressing button (17.3) on the control panel.

Using the coffee machine again after a malfunction

Using the coffee machine again after a malfunction

- ▶ A continuous tone indicates that the fresh water tank is empty.



Note:

Fill the fresh water tank. Press any button on the control panel of the coffee machine. The coffee machine resumes the program from the point at which it was interrupted.



Note:

If the kitchenette was switched off at the master switch on the instrument panel, the current program is cleared and it is necessary to restart the coffee machine. Empty the carafe and refill the filter.

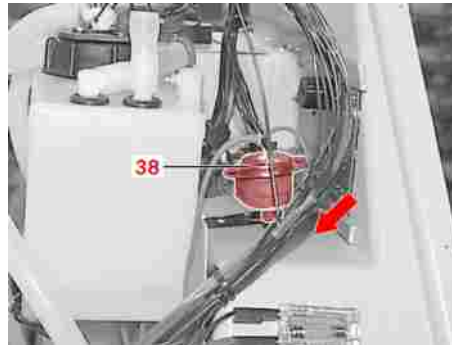

M86_00-0182-71

- ▶ Coffee machine fills with water but does not brew.



Note:

To rectify the malfunction, press overheating protection (38). Overheating protection (38) is accessible through an opening (arrowed) in the housing.

- ▶ Overheating protection triggered.



Note:

To reactivate the coffee machine, press overheating protection (38). Overheating protection (38) is accessible through an opening (arrowed) in the housing.

Using the boiler (option) again after a malfunction

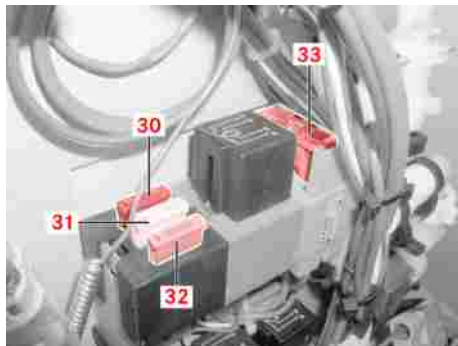

M86_00-0180-71



Note:

Or replace fuse (33).

Using the boiler (option) again after a malfunction

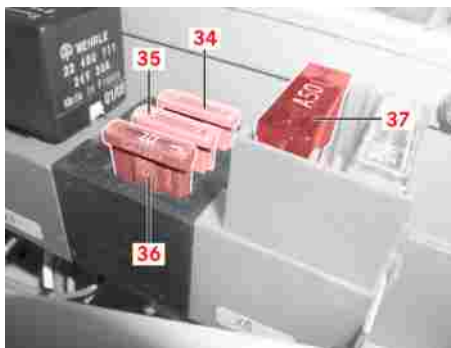

M86_00-0181-71

- ▶ The appliance does not dispense water.



Note:

Fill the fresh water tank with water. Or replace fuse (36). Or have the water pump exchanged by Customer Service.

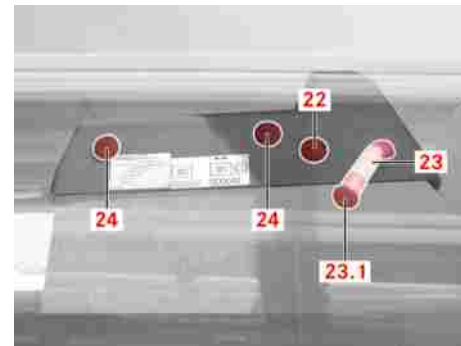

M86_00-0179-71

- ▶ The overheating protection is triggered if the boiler is operated with no water.



Note:

Fill the boiler with water to rectify the malfunction. Press button (24) to reactivate the overheating protection.

Other malfunctions

- ▶ Temperature of the water too low.



Note:

The heating time has not elapsed, it takes approximately 5 minutes.

- ▶ Inadequate flow of hot water.



Note:

Symptom of scaling, descale the boiler.

- ▶ Heating time too long.



Note:

Symptom of scaling, descale the boiler. Or the overheating protection has been triggered. Reactivate by pressing in button (24).

- ▶ Water flows out of the dispenser when the boiler is heating.



Note:

No malfunction, because water expands during the heating process.

Other malfunctions

- ▶ The kitchenette does not appear to be working, the battery display remains dark.



Note:

The kitchenette undervoltage protection has been triggered. Start the engine and charge the battery to rectify the fault.

Switching off the galley

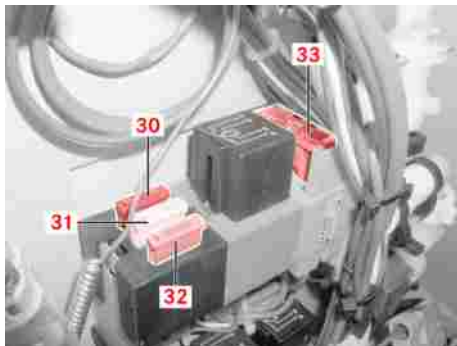

M86_00-0180-71

- ▶ Galley light does not switch on.

i Note:

Either change the bulb (24 V/5 W) (prise the left or right-hand lamp out of the kitchenette) or replace fuse (32).

- ▶ No water or irregular flow.

i Note:

Fill the fresh water tank with water. Check the water supply connection. Check the filter for clogging. Or replace fuse (30). Or have the water pump replaced by the after-sales service.

Switching off the galley

i Note:

All appliances must be switched off before the galley can be switched off.



M86_00-0170-71

- ▶ Switch off the galley light using button (3) on the control panel.

The galley light LED goes out.

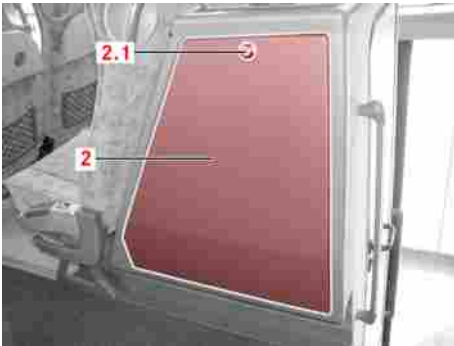

M86_00-0169-71

- ▶ Fit cover (2) and use lock (2.1) to secure.
The galley is locked away.



M68_00-0168-71

- ▶ Press galley master switch (18).
The LED in master switch (18) goes out.
The galley is switched off.

Enabling the lavatory	350
Switchover between water (WC) and chemical (CC) operation (option)	352
Flushing the WC	353
Drawing water at the handwash basin	354
Filling the soap dispenser	354
Adding paper hand towels	355
Adding toilet paper	355
Opening the basin undercabinet	355
Changing waste bags	356
Filling the fresh water storage tank	356
Emptying the fresh water storage tank	357
Emptying the solid waste container	358
Winter operation	359
Checking the residual current device for the 230 V socket (option)	360
Greasing the impeller of the CC pump	361

Enabling the lavatory

Enabling the lavatory



M86_00-0027-01

- ▶ To enable the lavatory, press switch (1) on the instrument panel with the ignition starter switch ON.



Note:

The LED in the switch lights up and the lavatory cabin lighting switches on. Option: The lavatory cabin door unlocks automatically whenever switch (1) is pressed and locks again when the switch is switched off.



Note:

The extractor fan in the lavatory cabin operates continuously while the engine is running.



M54_00-0978-01

Whenever the lavatory is locked from the inside, the extractor fans for the holding tank and lavatory cabin switch on and “WC occupied” symbol (2) appears in the passenger compartment display.



M86.00-0428-717

- ▶ Whenever the ignition starter switch is switched on, the smoke detector in the WC is also primed. LED (1) lights up green.



Note:

If LED (1) lights up green, the smoke detector is operating normally. In the event of slight contamination, LED (1) remains green but flashes yellow every so often. Heavy contamination of the detector is indicated by the LED flashing green and yellow alternately. Have the smoke detector exchanged by an OMNIplus Service

Partner. In the event of a malfunction, LED (1) flashes yellow.



Danger.

Whenever smoke is detected, LED (1) lights up red and a red alert is displayed on the display screen in the driver's area in conjunction with this icon.



M86.00-0432-71

- ▶ In an emergency, press red pushbutton (1) once.



M86.00-0433-71

A yellow alert appears on the display screen in the driver's area: WC toilet emergency call



Note:

This yellow alert is cleared if pushbutton (1) is pressed again.

Switchover between water (WC) and chemical (CC) operation (option)



M86_00-0028-01

▶ Opening a mechanically locked door

i Note:

If lock (2) on the lavatory cabin door has been locked mechanically, it can be unlocked by means of a suitable coin or a screwdriver.

Switchover between water (WC) and chemical (CC) operation (option)

i Note:

With this equipment version, the lavatory can be operated either as a water-flushed toilet or as a chemical toilet.

i Note:

If the lavatory is to be used as a chemical toilet, the holding tank must be filled with a certain amount of sanitary chemical after each time it has been emptied. To do this, pour approximately 20 litres of water into the lavatory bowl. Then add the sanitary chemical in the mixing ratio specified.



Caution:

Whenever you enable the lavatory for chemical operation, check that the CC pump runs correctly (briefly press the flush button). If the pump fails to run, it will need to be greased. –refer to section: “Greasing the impeller of the CC pump”



M86_00-0273-71

- ▶ Turn switch (1) to the left to switch over to chemical operation.

**Note:**

The switch is located behind the service cover to the front of the centre right door (door 2).

The lavatory will now be flushed with the sanitary chemical from the holding tank.

**Caution:**

Dry running would cause damage to the chemical fluid pump (impeller pump). For this reason, always ensure that there is a sufficient level of sanitary chemical fluid in the system.

- ▶ Turn switch (1) back to the right to switch back to water-flushing operation.

The lavatory will then be flushed with water from the fresh water tank.

Flushing the WC

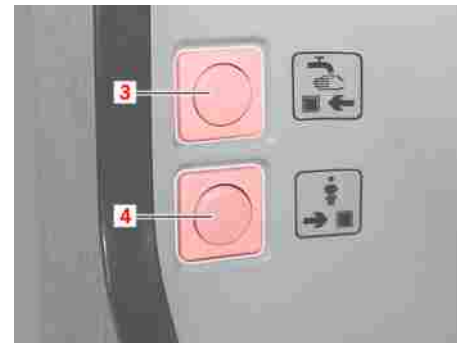

M86_00-0029-01

- ▶ The flushing process is triggered by pressing WC flush pushbutton (4).

**Note:**

The water pump is operated for approximately 5 seconds; at the same time, the gate valve to the solid waste container is opened.

Drawing water at the handwash basin

Drawing water at the handwash basin

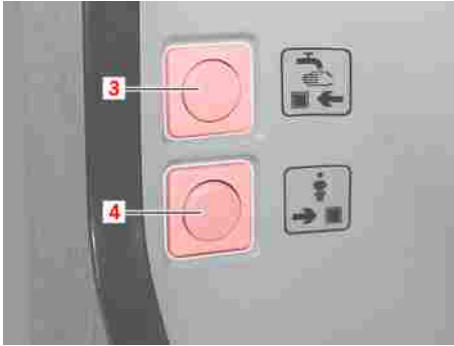

M86_00-0029-01

- ▶ The water pump runs for approximately 3 seconds when handwash basin water supply pushbutton (5) is pressed and water flows from the tap.



Danger.

The water from the tap is not of drinking water quality.



Note:

The waste water reaches the solid waste container via a system of hoses.

Filling the soap dispenser

- ▶ Open the cover by raising it slightly and pulling it towards you.



Note:

Remove the red cap from a new bottle. Place the new bottle in position with the writing facing forwards and push it gently into place. Pull the lever firmly to the right (closed position). Close the soap dispenser.

Adding paper hand towels

Adding paper hand towels

- ▶ Open the cover by raising it slightly and pulling it towards you.

**Note:**

Insert the towels as shown on the inside of the dispenser.

Adding toilet paper

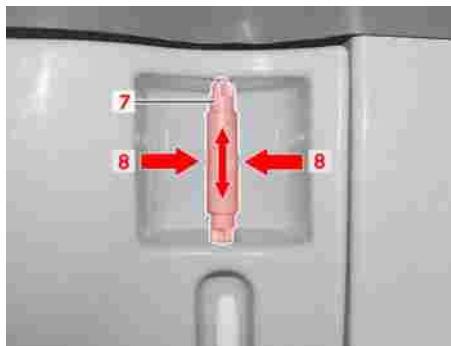

M86_00-0032-01

- ▶ Squeeze toilet paper holder (7) to remove and replace it.

Opening the basin undercabinet

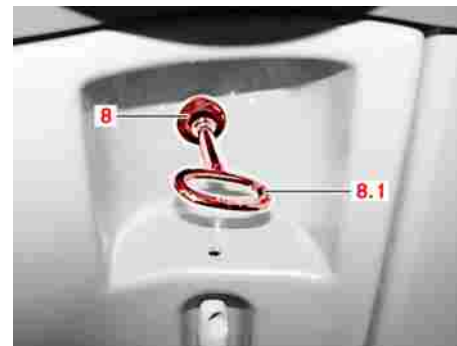

M86_00-0033-01

- ▶ Remove toilet paper holder (7), open lock (8) using the supplied square spanner (8.1) and fold open the basin undercabinet.

Changing waste bags

Changing waste bags



M86_00-0034-01

- ▶ Folding open the basin undercabinet makes it possible to secure a waste bag to the bottom of the waste chute by means of an elastic strap.



Note:

Waste chute (9) on the top of the wash-basin is for disposing of used paper towels.

Filling the fresh water storage tank

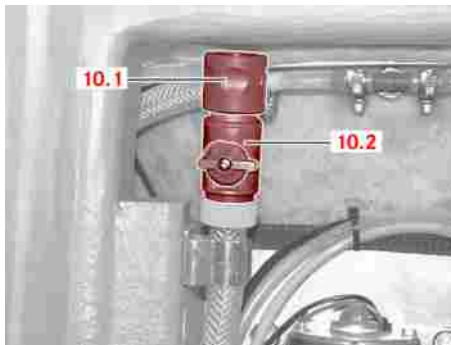

M86_00-0036-01

- ▶ Open the right service cover to the front of the centre right door. To fill the fresh water storage tank, connect a supply line between coupling (10.1) and an external water supply and open shut-off valve (10.2).



Danger.

Do not allow the filling process to continue unsupervised. If the water fill pressure is too high or if the overflow is blocked by a foreign object, there is a risk of the tank expanding and damaging the overlying floor.

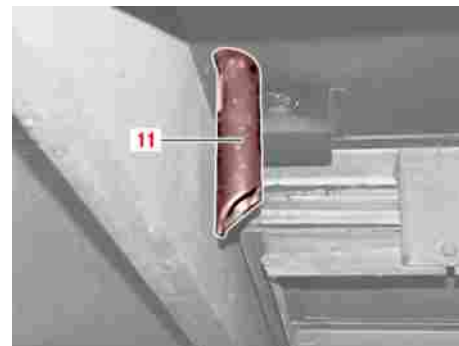

M86_00-0037-01

- ▶ Ending the filling operation

Emptying the fresh water storage tank

**Note:**

Water escapes from overflow (11) under the floor of the bus when the container is completely filled. Close the tap immediately, remove the hose.

**Danger.**

Do not add antifreeze to the fresh water storage tank - risk of poisoning.

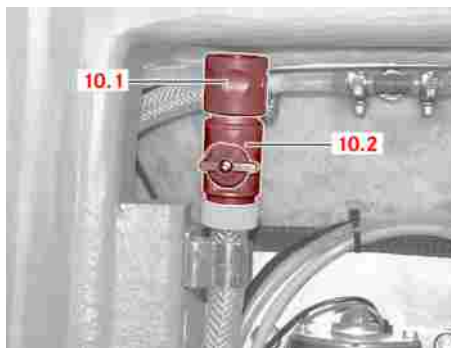
Emptying the fresh water storage tank

M86_00-0036-01

- ▶ To empty the fresh water storage tank, take the filler hose from the holder and open shut-off valve (10.2) on the coupling (10.1). Let the water run out.

**Note:**

The fresh water storage tank must be emptied if the bus or the lavatory is to remain out of service for some time.

**Danger.**

Observe the notes on winter operation to prevent damage to water-carrying installations during freezing weather conditions.

Emptying the solid waste container

Emptying the solid waste container



M86_00-0038-01

- ▶ To empty the solid waste container, it is necessary to park the bus such that the solid waste drainage opening (12) is positioned over a suitable waste collection point.

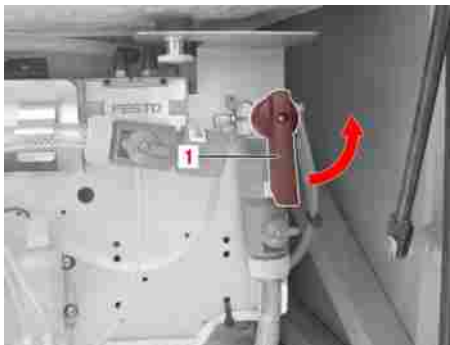

M86_00-0366-71

- ▶ Turn compressed-air tap (1) in the service cover on the right to the front of the centre right door.



Note:

The drainage valve on the solid waste container is opened.



Environmental protection

Dispose of sewage in an environmentally responsible manner. Observe the rules and regulations of the country concerned.

Winter operation

**Note:**

Empty the whole system if there is a risk of frost.

- ▶ Empty the fresh water storage tank.

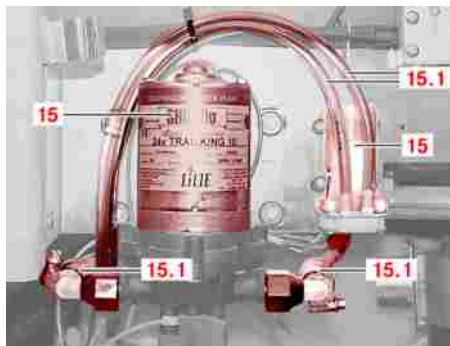

M86_00-0040-01

- ▶ Disconnect the lines (15.1) to the pumps (15) and let them run empty.

**Note:**

Operate the pumps using the pushbuttons (3 or 4) until all of the water has run out. Reconnect the lines.

- ▶ Empty the solid waste container.

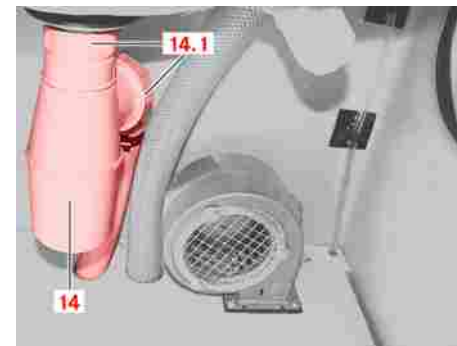

M86_00-0039-01

- ▶ Unscrew the siphon (odour trap) (14) in the basin undercabinet from the handwash basin at the union nuts (14.1), empty and fill with antifreeze mat. no. A 001 986 45 71 11. Re-assemble the siphon (14).

Checking the residual current device for the 230 V socket (option)

Checking the residual current device for the 230 V socket (option)



Danger.

The residual current device must be tested for correct operation monthly to rule out the risk of endangering passengers as a consequence of a faulty electrical system.

- ▶ Open the basin undercabinet using a square key.

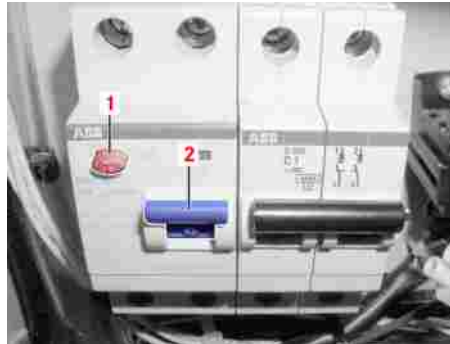

M86_00-0290-71

- ▶ Press trip button (1).



M68_00-0183-71

The RCD must trip.



Note:

If the RCD does not trip, switch off the 230 V system by operating electrical circuits >100 V switch (1) and have the system checked by an OMNIplus Service Partner.

- ▶ Switch the RCD back on by pressing make lever (2) back up.
- ▶ Close the basin undercabinet again.

Greasing the impeller of the CC pump

Greasing the impeller of the CC pump

**Note:**

If the CC has been out of operation for a lengthy period, the impeller could seize and the CC pump would fail.

**Note:**

If the CC has been out of operation for a lengthy period, e.g. after the summer season during which only WC operation was active, we recommend that the impeller of the CC pump be greased before switching from WC to CC operation.

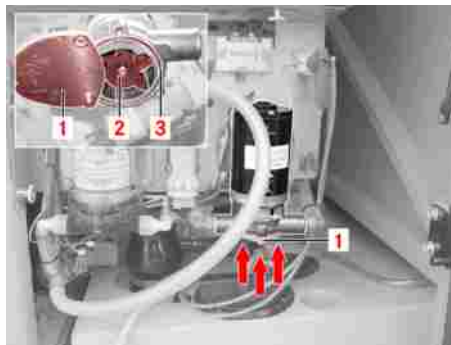

M86_00-0355-71

- ▶ Undo the securing screws (arrowed) and remove cover (1) downwards.

**Danger.**

Residues may be expelled from the CC pump as the cover is opened. The residues are caustic and must not be allowed to come into contact with skin, eyes or clothing. Rinse affected areas immediately and thoroughly with clean water. Seek medical attention if necessary. Wear protective equipment (gloves, goggles, etc.).

**Danger.**

Observe the instructions issued by the manufacturer when handling sanitary fluids.

- ▶ To make the seized impeller easier to move, coat the outer sides of impeller (2) with approximately 5 - 10 g Vaseline or multipurpose grease.
- ▶ To distribute the grease evenly, turn impeller (2) several times in the direction of rotation.
- ▶ Seal (3) should also be coated with grease.
- ▶ Resecure cover (1).

Overview of the operating, function and malfunction display screen	368
Engine oil level display	376
Oil level alerts	377
Oil level information	379
Checking the engine oil level with the dipstick (option)	382
Safety precautions for work carried out in the engine compartment	383
Removing the drive belts (OM 470)	384
Fitting the drive belts (OM 470)	386
Checking the coolant level of the engine and heating system	389
Tyres - operating safety and roadworthiness	390
Tyre pressure	391
Tyre tread	391
Tyre condition	392
Tyre age	392
Invisible tyre damage	392
Tyre load capacity, top speed of tyres and types of tyres	393

Table of contents

Retreaded tyres	393
Tyre pressures table 295/80 R 22.5	394
On-screen tyre pressure monitor	395
Safety measures to be taken in the event of a flat tyre or a wheel change	396
Fitting snow chains	397
Removing the spare wheel from the spare wheel cover	398
Positioning the jack	399
Removing the wheel nut cover or wheel trim (option)	400
Removing the wheels	401
Fitting the spare wheel	406
Fitting the wheel nut cover or wheel trim (option)	408
Inflating tyres using the tyre inflator connection (option)	409
Pneumatic system test ports under the driver's area	412
Pneumatic test ports behind door 2	414
Other pneumatic test ports	416
Charging the compressed-air system of another bus (option)	417

Operating the bus stop brake/drive-off lock emergency release switch (option)	419
Operating/malfunction displays: steering system	420
Bleeding the fuel system using the electric fuel pump (option)	420
Replacing the water heater fuel filter	421
Electrical system safety precautions	421
General safety precautions for batteries	422
Safety precautions for handling batteries	422
Measures required for the prevention of damage to buses or components during electric welding work	423
Electrical system (illustration shows 15 RHD as an example)	426
Battery isolating switch (with switch-off authorisation LED)	428
Driver's area interior switch panel	430
Main switch panel (under the driver's area)	432
Auxiliary switch panel	434
PDB fuse switch panel	436
Ceiling switch panel	438

Table of contents

Electrical connection for the roof-mounted system (heating, ventilation, air-conditioning)	440
Battery compartment	442
Notes on fuse assignments	443
Fuse assignment for the driver's area interior switch panel, Tourismo RHD	444
Fuse assignment for the main switch panel (under the driver's area), Tourismo RHD	446
Fuse assignment for the auxiliary switch panel, Tourismo RHD	448
Fuse assignment for auxiliary switch panel with PDB	452
Fuse assignment for the power distribution board (PDB), Tourismo RHD	456
Fuse assignment for the ceiling switch panel, Tourismo RHD	460
Fuse assignment for roof-mounted heating, ventilation and air-conditioning system (Webasto)	462
Fuse assignment for roof-mounted heating, ventilation and air-conditioning system (Konvekta)	464
Handling fuses	465
Disconnecting vehicle batteries	466
Recharging vehicle batteries	468
Notes on jump-starting	468
Jump-start procedure	469

Activation of on-board diagnostics	470
Interpreting the on-board diagnostics screen display	471
Clearing the fault memory of the selected system	472
Ending on-board diagnostics	472
Changing bulbs	472
Adjusting the headlamps for driving on the left or right (only in buses with bi-xenon headlamps)	477
Emergency operation of the doors (depressurising the doors using the emergency valves)	478
Emergency unlocking of the luggage compartment flaps in the event of a compressed-air supply failure	479
Removing the exterior mirror, fitting the emergency mirror (option)	481
Emergency operation for heating in driver's area	482
Emergency operation of the passenger-compartment heating	483
Maintenance tasks for the air-conditioning system in the bus (filter maintenance)	484
Scopes of maintenance for the air-conditioning system	486
Cleaning the heating system water filter	489
Bleeding the coolant circuit for the heating system	491

Overview of the operating, function and malfunction display screen

Overview of the operating, function and malfunction display screen



M68_00-0216-71

Screen (1) is a status indicator that displays operational, functional and malfunction information (icons). Additionally, it can be used to display on-board diagnostics information.











Note:









The following icons can be displayed on the display screen:









Symbol	Description
	Alternator malfunction
	Alternator 1 malfunction
	Alternator 2 malfunction
	Alternator 3 malfunction
	Battery undervoltage
	Battery overvoltage
	Electrical malfunction

Symbol	Description
	FPS malfunction, entire system
	FPS 1 malfunction
	FPS 2 malfunction
	FPS 3 malfunction
	FPS 4 malfunction
	FPS 5 malfunction
	FPS 6 malfunction
	FPS 7 malfunction

























Overview of the operating, function and malfunction display screen

Symbol	Description
	FPS 8 malfunction
	Power supply FPS 1
	Power supply FPS 2
	Power supply FPS 3
	Power supply FPS 4
	Power supply FPS 5
	Power supply FPS 6
	Power supply FPS 7









Symbol	Description
	Power supply FPS 8
	Service instruction
	Service overview
	Engine control (MR) malfunction or failure
	Immobiliser malfunction
	Starter inhibitor active
	Air cleaner service due
	Engine torque reduction







Symbol	Description
	Drive control (FR) malfunction or failure
	Particulate filter
	Cruise control active
	Variable speed limiter active
	Automatic speed limiter warning message
	Engine braking effect
	Check
	Transmission in neutral







Overview of the operating, function and malfunction display screen

Symbol	Description	Symbol	Description	Symbol	Description
	Reverse gear selected		Transmission 6th gear		Retarder preselected
	Forwards gear selected		Transmission 7th gear		Retarder active
	Automatic mode		Transmission 8th gear		Retarder temperature too high
	Transmission 1st gear		Clutch overloaded, foot off the accelerator pedal		Pedal-activated continuous braking
	Transmission 2nd gear		Transmission compressed-air supply too low		Engine oil level too low
	Transmission 3rd gear		Transmission emergency program		Engine oil pressure too low or sensor failure
	Transmission 4th gear		Transmission malfunction		Oil replenishment
	Transmission 5th gear		Transmission oil temperature		Engine oil temperature too high























Overview of the operating, function and malfunction display screen

Symbol	Description
	Coolant level too low or sensor failure
	Coolant temperature too high or sensor failure
	Brake circuit 1 and/or 2 pressure sensor malfunction
	Brake circuit 1 supply pressure too low
	Brake circuit 2 supply pressure too low
	Parking brake applied
	Brake pad wear indicator electronics malfunction or not available
	Brake pad wear





Symbol	Description
	Parking brake supply pressure too low or sensor failure
	Bus stop brake/drive-off lock active
	Bus stop brake/drive-off lock malfunction or emergency release switch operated
	Brake pad wear sensor, front axle right-hand side (2-axle bus)
	Brake pad wear sensor, driven axle right-hand side (2-axle bus)
	Brake pad wear sensor, front axle left-hand side (2-axle bus)
	Brake pad wear sensor, driven axle left-hand side (2-axle bus)



Symbol	Description
	Brake pad wear sensor, front axle right-hand side (3-axle bus)
	Brake pad wear sensor, driven axle right-hand side (3-axle bus)
	Brake pad wear sensor, trailing axle right-hand side (3-axle bus)
	Brake pad wear sensor, front axle left-hand side (3-axle bus)
	Brake pad wear sensor, driven axle left-hand side (3-axle bus)
	Brake pad wear sensor, trailing axle left-hand side (3-axle bus)
	ABS/ASR system failure or malfunction







Overview of the operating, function and malfunction display screen

Symbol	Description	Symbol	Description	Symbol	Description
	ASR slip increase active		Circuit 3 supply pressure display		Lubrication system
	Brake system wheel speed sensor malfunction		Compressed-air supply air intake filter dirty		Main-beam headlamps
	ABS trailer malfunction		Bus not at normal level		Dipped-beam headlamps
	Electronic Stability Program ESP (dynamic handling control (FDR) or acceleration skid control (ASR)) active		Bus above normal level		Side lamps
	Electronic Stability Program (ESP) deactivated		Bus below normal level		Trailer turn signals
	Electronic Stability Program (ESP) malfunction		Trailing axle steering (RAS) system pressure too low		Front foglamps
	Auxiliary consumers compressed-air supply pressure too low or sensor failure		Steering hydraulics oil level too low		Rear foglamp
			Axle load transfer active		Lights general























Overview of the operating, function and malfunction display screen

Symbol	Description
	Lighting fault
	Main-beam headlamps faulty
	Dipped-beam headlamps faulty
	Side lamps faulty
	Trailer turn signals faulty
	Front foglamps faulty
	Rear foglamp faulty
	Brake lamps









Symbol	Description
	Brake lamps faulty
	Reversing lamp
	Reversing lamp faulty
	Windscreen heating
	Driver's window demister set to MAX
	Mirror heating
	Side window heating
	Windscreen washer fluid level too low

Symbol	Description
	Emergency valve for door 1 or door 2 operated
	Emergency hammer removed
	Ready to depart
	Door 1 open
	Door 1 malfunction
	Door 2 open
	Door 2 malfunction
	Disabled passengers' lift extended









Overview of the operating, function and malfunction display screen

Symbol	Description	Symbol	Description	Symbol	Description
	Stop request		Auxiliary heating unit program 2		Interior temperature / malfunction message for heating/ventilation/air-conditioning (HVAC)
	Ramp request		Auxiliary heating unit program 3		Passenger-compartment setpoint temperature
	Pushchair request		AC compressor in operation		Temperature lockout (requested function not available)
	Service call		Air-conditioning system or reheat not available		“Smog” air-recirculation mode for driver’s area and passenger compartment
	Disabled passengers' space stop request		Auxiliary heating switch-on duration		Passenger compartment heating/ventilation/air-conditioning off
	Driver’s area blower		Auxiliary heating unit remaining time		Front roof hatch in air-in position
	Blower speed		Comfort temperature setting		Front roof hatch in air-out position
	Auxiliary heating unit program 1		Passenger compartment blower		

Overview of the operating, function and malfunction display screen

Symbol	Description
	Front roof hatch fully open
	Rear roof hatch in air-in position
	Rear roof hatch in air-out position
	Rear roof hatch fully open
	Roof hatch emergency unlocked (emergency exit)
	Heating - ventilation in passenger compartment
	Heating/ventilation/air-conditioning (HVAC) air cleaner dirty
	Auxiliary heating unit combustion indicator

Symbol	Description
	Auxiliary heating unit not available
	Malfunction, general
	Ignition switch malfunction
	Belt warning
	Fire message
	Reserve fuel level
	Fuel tank level sensor malfunction
	AdBlue® reservoir level below approximately 33 %

Symbol	Description
	Fuel filter dirty
	Fuel heater
	Fuel-oil supply level too low
	WC, toilet
	Water tank level too low
	WC solid waste container nearly full
	Refrigerator open
	Flap warning indicator for open flap

Engine oil level display

Symbol	Description
	Central locking of the left-side luggage compartment flaps
	Central locking of the right-side luggage compartment flaps
	Unauthorised door lock
	Prompt to browse forward using display control pushbutton
	Prompt to acknowledge using the Quit pushbutton

Engine oil level display



M68_00-0216-71

Information about the engine oil level is always displayed on screen (1). Oil level messages are displayed when the oil level exceeds or falls below certain thresholds for the first time, and information about the oil level can be called up manually in a specific on-screen menu.



Note:

Oil level information cannot be called up unless the bus is stationary.



Caution:

There is a risk of engine damage if the oil level is too low or too high. Therefore, correct the oil level as soon as possible.



Note:

The oil level messages that may be displayed and the oil level information to which these relate are described in the following sections.

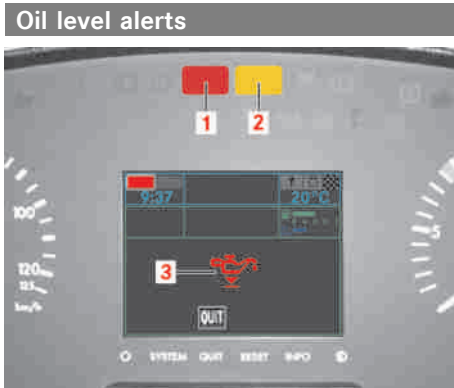

M54.00-2095-71

Oil level alerts are displayed to the driver directly by means of “Engine oil level” symbol (3) in conjunction with a red (1) or yellow (2) warning level malfunction.

i Note:

To be able to acknowledge oil level alerts of the yellow warning level (2), the driver has to press the “Display control” pushbutton or the “Quit” button below the screen.

i Note:

To be able to acknowledge oil level alerts of the red warning level (1), the driver has to press the “Quit” button below the screen with the parking brake applied.

Oil level alert

The driver may see the following oil level alerts:

Engine oil level at service limit



M54.00-2096-71

“Service reminder” symbol (1) is displayed if the engine oil level has reached the point where maintenance is required.

The “Serviceübersicht” (Service overview) menu displaying the current message (2) must now be called up using the “Display control” pushbutton or the “Quit” button below the screen. To call up the oil level information, the “Betriebsanzeigen Motor” (Engine operating displays) menu can be called up using the “Display control” pushbutton (refer to “Oil level information”).

i Note:

Correct the oil level within the next 1,000 km.

i Note:

“Service reminder” symbol (1) may also be displayed as a maintenance indicator for other systems or assemblies and is displayed until the necessary maintenance work is carried out on the system or assembly concerned.

Oil level alerts

Engine oil level too low



M54.00-2097-71

If the engine oil level is too low, this is indicated by yellow warning level message (1) and “Engine oil level” icon (2). To be able to acknowledge this alert, the driver has to press the “Display control” pushbutton or “Quit” button (3) below the screen. To call up the oil level information, the “Betriebsanzeigen Motor” (Engine operating displays) menu can now be called up using the “Display control” pushbutton (refer to “Oil level information”).



Caution:

There is a risk of engine damage if the oil level is too low. For this reason, correct the oil level at the earliest opportunity.

Engine oil level too high



M54.00-2097-71

If the oil level is too high, this is indicated by yellow warning level message (1) and “Engine oil level” symbol (2). To be able to acknowledge this alert, the driver has to press the “Display control” pushbutton or “Quit” button (3) below the screen. To call up the oil level information, the “Betriebsanzeigen Motor” (En-

gine operating displays) menu can now be called up using the “Display control” pushbutton (refer to “Oil level information”).



Caution:

There is a risk of engine damage if the oil level is too high. For this reason, correct the oil level at the earliest opportunity.

Engine oil level critical



M54.00-2098-71

If the oil level is critical, this is indicated by red warning level message (1) and “Engine oil level” symbol (2). At the

same time, a warning buzzer sounds. To be able to acknowledge this alert, the driver has to press the “Quit” button below the screen with the parking brake applied. The oil level must be corrected immediately. To call up the oil level information, the “Betriebsanzeigen Motor” (Engine operating displays) menu can be called up using the “Display control” pushbutton (refer to “Oil level information”).



Danger.

Risk of accident. Red warning level malfunction warnings (1) indicate that the operating safety or roadworthiness of the bus is at risk. The driving and braking characteristics of the bus may change. Stop immediately (traffic conditions permitting) and switch off the engine.

Oil level information

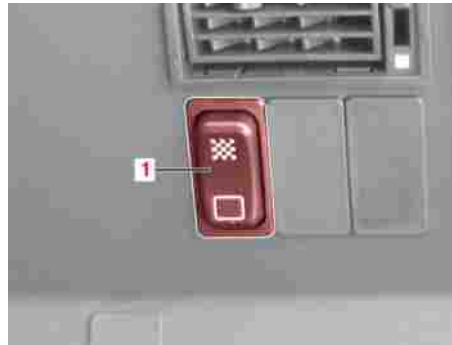

M68.00-0664-71

To call up the oil level information, the “Betriebsanzeigen Motor” (Engine operating displays) menu must be called up using “Display control” pushbutton (1) on the instrument panel. The oil level information informs you whether the oil level is correct or not.



Note:

The oil level cannot be measured unless the engine is switched off and the ignition starter switch is in the ON position. When the engine is switched on, the most recently recorded oil level value shown on the screen remains frozen. The actual oil level is not displayed again until the ignition starter switch has been switched to OFF and back to ON.



Caution:

The bus must be level when the oil level is measured. If the oil level is measured with the bus on an incline, an incorrect oil level will be displayed on the screen and a yellow or red alert may appear on the instrument panel.

Oil level information



Danger.

Risk of accident. Calling up information manually while the vehicle is in motion will distract you from the road and traffic conditions. This could result in an accident with serious or fatal injuries. Therefore: Do not call up information manually unless the bus is stationary and the parking brake is applied.

Oil level information

The following oil level information can be displayed:

Engine oil level OK



M54.00-2099-71

If the engine oil level is within the normal range, this is indicated by the “Engine oil level” symbol and OK.



Note:

If the oil level is OK, it is not possible to call up any further oil level information.

Engine oil level too low



M54.00-2100-71

If the engine oil level is too low, this is indicated by the “Engine oil level” symbol and the top-up amount in litres (4.5 litres in this display example).



Note:

If the top-up amount required is not sufficient for a service or yellow alert to be shown, the oil level must be corrected within the next 2,000 km.



Caution:

If the top-up amount required is displayed by means of a service notification, this amount should be added within the next 1,000 km, or within the next 200 km in the event of a yellow alert.



Danger.

If a critical engine oil level is displayed in conjunction with a red alert, the bus must be stopped immediately (traffic conditions permitting) and the engine switched off, otherwise there is a risk of severe engine damage.



Caution:

The bus must be level when the oil level is measured. If the oil level is measured with the bus on an incline, an incorrect oil level will be displayed on the screen and a yellow or red alert may appear on the instrument panel.

Engine oil level too high



M54.00-2101-71

If the engine oil level is too high, this is indicated by the “Engine oil level” symbol and “> max”. In addition, yellow warning level indicator lamp (1) lights up.



Caution:

There is a risk of engine damage if the oil level is too high. For this reason, correct the oil level at the earliest opportunity.



Caution:

The bus must be level when the oil level is measured. If the oil level is measured with the bus on an incline, an incorrect oil level will be displayed on the screen and a yellow or red alert may appear on the instrument panel.

Engine oil level cannot be measured



M54.00-2102-71

If the oil level cannot be measured, e.g. due to a sensor fault, this is indicated by the “Engine oil level” symbol and “-----L”. This display will also appear if the oil

Checking the engine oil level with the dipstick (option)

level is called up while the vehicle is in motion.



Caution:

Check the oil pressure with the engine running and visit the nearest Service Partner. Adopt a cautious driving style.

Checking the engine oil level with the dipstick (option)



Note:

Park the bus on horizontal ground.



Danger.

Prevent the engine from being switched on. Remove the key from the ignition starter switch.

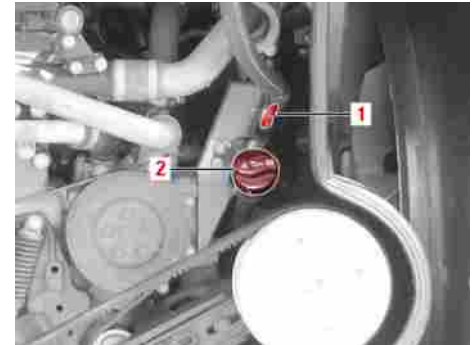

M01.00-0147-71

- ▶ Pull out dipstick (1) with the engine switched off and at normal operating temperature.



Note:

After you have switched off the engine, wait approximately 10 minutes to allow the oil to collect in the oil sump.

Safety precautions for work carried out in the engine compartment



Note:

The oil level must be visible between the minimum and maximum markings.

- ▶ At filler opening (2), add the top-up volume required in accordance with the Specifications for Service Products.



Note:

The engines have an electronic oil level sensor that provides a definitive reading.



Note:

Top up by the amount required as shown on the display screen. Then run the engine for approximately 20 minutes (idling speed or vehicle in motion). The screen display is updated only after this time has elapsed.

Safety precautions for work carried out in the engine compartment



Danger.

Never leave the engine running when work is being carried out in the engine compartment.



Danger.

Prevent the engine from being switched on without authorisation. Remove the key from the ignition starter switch.



Danger.

If the engine is at operating temperature, leave it to cool down - risk of burns.

the tension of the new belt, drive the bus to the nearest OMNIplus Service Partner as soon as possible and have the belt tension and tightening torques checked.

The replacement V-belts, spare parts and assembly tools required are not supplied with the bus as standard.

If the bus has broken down and it is necessary to replace a drive belt but no suitable gauge is available for checking

Removing the drive belts (OM 470)

Removing the drive belts (OM 470)

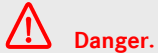

Danger.

Do not carry out work in the engine compartment unless the engine has been switched off and the ignition key has been removed. If the engine is at normal operating temperature, give it sufficient time to cool down: risk of burns.



Caution:

Replacement V-belts and some of the tools listed below are not supplied with the bus as standard. Only the use of OMNIplus original replacement V-belts is permitted.

Removing the fan drive belt

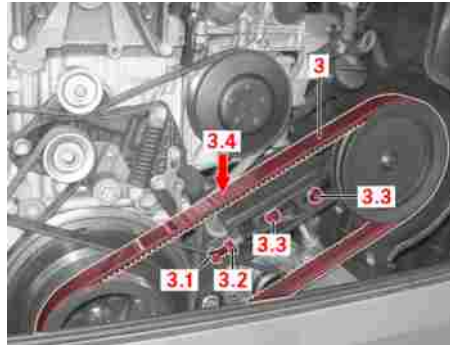

M01_00-0132-71

- ▶ Loosen lock nut (3.2) of adjustment screw (3.1) on the belt tensioner carrier.
- ▶ Unscrew adjustment screw (3.1).
- ▶ Loosen screws (3.3) securing the belt pulley tensioning lever mounting.
- ▶ Move tensioning lever mounting with belt pulley to the stop against the carrier and remove the drive belt.

Removing the drive belt for the refrigerant compressor



Note:

Required tools: 1/2" tommy bar.

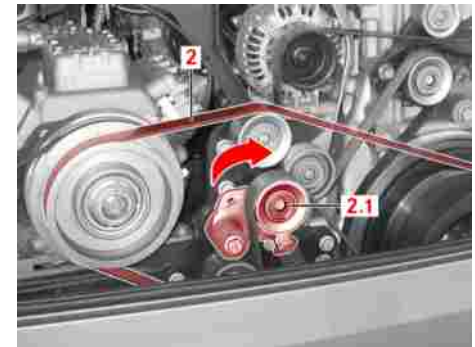

M01_00-0134-71

- ▶ Fit the 1/2" tommy bar into the socket on tensioning pulley (2.1), pull the tensioning pulley down in the direction of the arrow using the tommy bar and hold in place.
- ▶ Remove the drive belt from the belt pulleys.

Removing the drive belts (OM 470)

Removing the drive belt for the right-side alternator

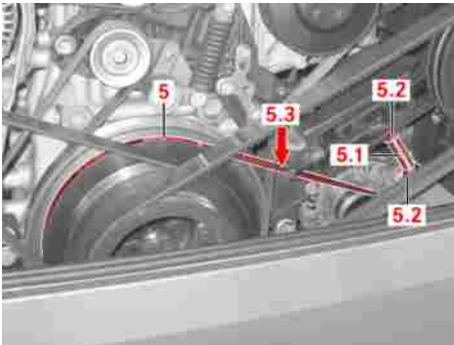

M01.00-0139-71

- ▶ Loosen lock nuts (5.2).
- ▶ Loosen the screws at the alternator hinge point and at the tensioning spindle.
- ▶ Loosen tensioning screw (5.1) until the drive belt is lying loosely on the belt pulleys.
- ▶ Remove drive belt (5) from the belt pulleys.

Removing the drive belt for the left-side alternator

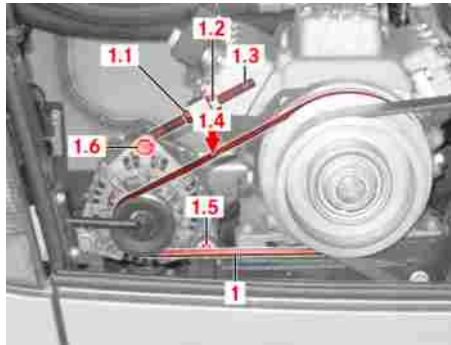

M01.00-0153-71

- ▶ Loosen lock nut (1.2) and loosen the screws at the alternator hinge point (1.5/1.6) and at the tensioning spindle.
- ▶ Loosen clamp nut (1.1) until the drive belt is lying loosely on the belt pulleys.
- ▶ Remove drive belt (1) from the belt pulleys.

Removing the drive belt for the water pump and centre alternator



Note:

Required tools: 1/2" tommy bar.

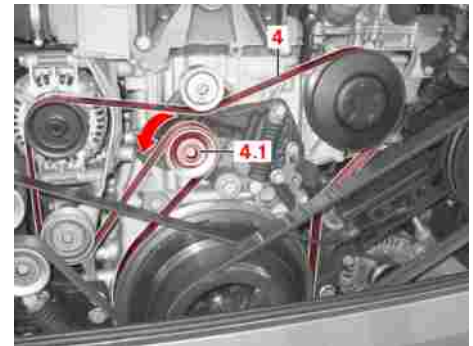

M01_00-0135-71

- ▶ Fit the 1/2" tommy bar into the socket on tensioning pulley (4.1), pull the tensioning pulley down in the direction of the arrow using the tommy bar and hold in place.
- ▶ Remove the drive belt from the belt pulleys.

Fitting the drive belts (OM 470)

Fitting the drive belts (OM 470)



Danger.

Do not carry out work in the engine compartment unless the engine has been switched off and the ignition key has been removed. If the engine is at normal operating temperature, give it sufficient time to cool down: risk of burns.



Danger.

Do not use force (e.g. by using an assembly lever) to pull drive belts onto the belt pulley edges during assembly. Doing so could result in hidden damage to the cord, which would considerably reduce the service life of the belt.

Fitting the drive belt to the left-side alternator

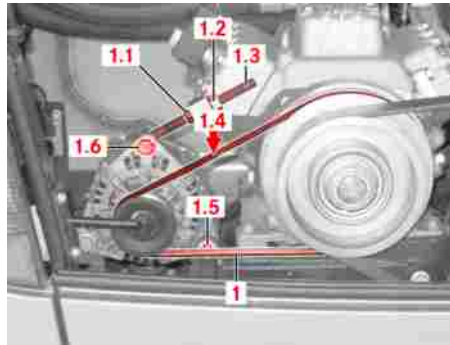

M01.00-0153-71

- ▶ Manually lay new drive belt (1) on the belt pulleys for the alternator and air-conditioning compressor.



Caution:

Make sure that the belt profile is aligned with the pulley profile.

- ▶ Tighten tensioning nut (1.1) using an open-ended spanner until the required belt tension has been achieved.



Note:

The drive belt tension must not be too high under any circumstances. It must still be possible to twist the drive belt through at least 90° at measuring point (1.4) using two fingers.



Caution:

Visit your nearest OMNIplus Service Partner to have the drive belt tension adjusted correctly using a tension meter and to have the screws tightened to the correct torque.

- ▶ Tighten lock nut (1.2) of the tensioning spindle using an open-ended spanner. Tighten the screws at the alternator hinge point (1.5/1.6) and at the tensioning spindle.

Fitting the drive belt for the water pump and centre alternator

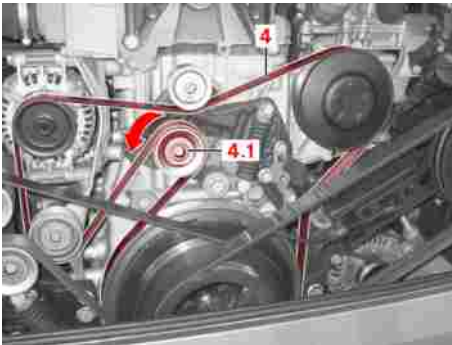

MO1_00-0135-71

- ▶ Manually lay new drive belt (4) on the belt pulleys for the crankshaft and on the idler pulley and belt pulley for water pump and alternator.
- ▶ Fit the 1/2" tommy bar into the socket on tensioning pulley (4.1), turn the tensioning pulley down in the direction of the arrow using the tommy bar and hold in place.
- ▶ Lay drive belt (4) on tensioning pulley (4.1).



Caution:

Make sure that the belt profile is aligned with the pulley profile.



Note:

Tensioning pulley (4.1) is spring-loaded; the drive belt is therefore adjusted to the correct tension automatically.

Fitting the drive belt to the right-side alternator

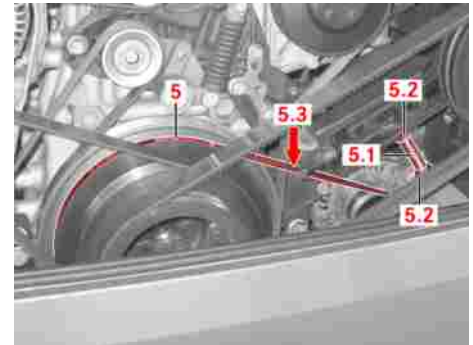

MO1.00-0139-71

- ▶ Manually lay new drive belt (5) on the belt pulleys for the right-side alternator and crankshaft.



Caution:

Make sure that the belt profile is aligned with the pulley profile.

- ▶ Tighten the tensioning screw until the required belt tension has been achieved.

Fitting the drive belts (OM 470)



Caution:

The drive belt tension must not be too high under any circumstances. It must still be possible to twist the drive belt through at least 90° at measuring point (5.3) using two fingers.



Caution:

Visit your nearest OMNIplus Service Partner to have the drive belt tension adjusted correctly using a tension meter.

- ▶ Tighten lock nuts (5.2) of the tensioning screw using an open-ended spanner. Tighten the screw at the alternator hinge point and at the tensioning spindle.
- ▶ Manually lay new drive belt (2) on the belt pulleys for the crankshaft and on the idler pulley and belt pulley for the refrigerant compressor.
- ▶ Fit the 1/2" tommy bar into the socket on tensioning pulley (2.1), pull the tensioning pulley down in the direction of the arrow using the tommy bar and hold in place.
- ▶ Lay drive belt (2) on the tensioning pulley.

Fitting the refrigerant compressor drive belt

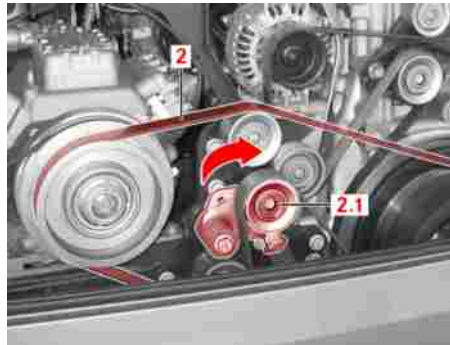

M01_00-0134-71



Caution:

Make sure that the belt profile is aligned with the pulley profile.



Note:

Tensioning pulley (2.1) is spring-loaded; the drive belt is therefore adjusted to the correct tension automatically.

Checking the coolant level of the engine and heating system

Fitting the fan drive belt

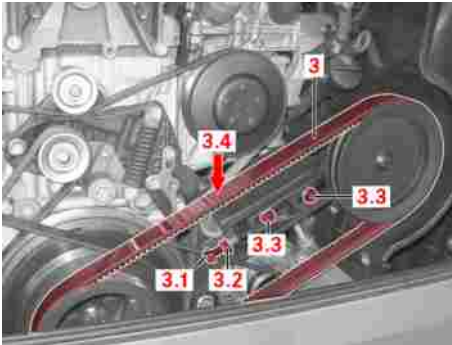

M01_00-0132-71

- ▶ Manually lay new drive belt (3) on the belt pulleys for the crankshaft and fan drive.
- ▶ Screw adjustment screw (3.1) into the carrier until it makes contact with the tensioning lever mounting.



Caution:

The drive belt tension must not be too high under any circumstances. It must still be possible to twist the drive belt through at least 90° at measuring point (3.4) using two fingers.



Note:

Visit your nearest OMNIplus Service Partner to have the drive belt tension adjusted correctly using a tension meter.

- ▶ Secure the position of adjustment screw (3.1) using lock nut (3.2)
- ▶ Secure the tensioning lever mounting to the carrier using securing screws (3.3).

Checking the coolant level of the engine and heating system

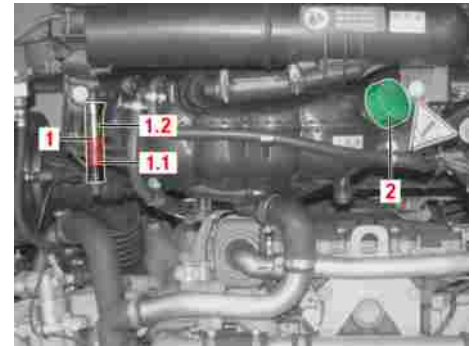

M54.00-2108-71

- ▶ Read off the coolant level



Danger.

Risk of scalding to skin and eyes from hot coolant spraying out. Wear protective clothing (gloves/safety goggles). Do not open the sealing cap on the coolant expansion tank unless the coolant temperature is below 90 °C. Open the sealing cap slowly to relieve the excess pressure. Then turn the cap a little further and remove it. Risk of poisoning if coolant is swallowed.

Tyres - operating safety and roadworthiness



Note:

The coolant level must be between the upper and lower marks (minimum (1.1) and maximum (1.2)) at expansion tank inspection glass (1) when the engine is cold (below 50 °C).

► Add coolant



Caution:

Do not top up unless the engine is cold.



Note:

Use clean water – well filtered and as soft as possible (drinking water quality) – mixed with corrosion inhibitor/antifreeze (comply with the Specifications for Service Products).



Note:

Only the use of a coolant specified on MB Specifications for Service Products sheet 325.5 or 326.5 (G40) is permitted. (The colour of the coolant is pink.)



Note:

For notes on bleeding the heating system coolant circuit, refer to the “Practical advice” section.

Tyres - operating safety and roadworthiness

Tyres are particularly important for the operating safety and roadworthiness of the bus.



Note:

The pressure, tread and condition of the tyres should therefore be checked on a regular basis.



Caution:

The use of wheel balancing agents, such as balancing powder, beads or gel, is not permitted as these may lead to undesirable pulsations and/or vibrations.

Tyre pressure

Check the specified tyre pressure regularly – at least once a week and before longer journeys – when the tyres are cold.

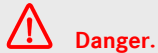

Danger.

Always observe the specified tyre pressures for your bus. The temperature and pressure of the tyres increase when the bus is in motion. For this reason, you should never reduce the pressure of warm tyres. The tyre pressures would then be too low once the tyres had cooled. If the tyre air pressure is too low, the tyre is liable to burst, particularly with increasing numbers of passengers/load and speed. This could result in you losing control of your bus and causing an accident, thereby injuring yourself and other people.



Note:

If the tyre pressure is too low, this leads to intensive heating of the tyres, increased tyre wear, changes in directional stability and increased fuel consumption.



Note:

If the tyre pressure is too high, this results in a longer braking distance, poorer tyre grip and increased tyre wear.



Caution:

Caps on the tyre inflation valves protect the valve inserts from moisture and dirt. The caps on the tyre inflation valves should therefore always be screwed on tightly.

Tyre tread

A minimum tyre tread depth is specified by law. Comply with the legal specifications for the relevant country.

As the remaining tread depth reduces, the less effective the road grip and handling characteristics of the bus become, particularly on wet or snowy roads.

In the interest of safety, have the tyres replaced before the legally-specified minimum tread depth is reached.



Danger.

Always ensure that there is sufficient tyre tread. Insufficient tyre tread depth increases the risk of aquaplaning if the bus is driven at high speed during heavy rain or in slush. The tyre tread can no longer deflect the water away. This could result in you losing control of your bus and causing an accident, thereby injuring yourself and other people.

Tyre condition

Tyre condition

Before setting off, check the tyres on the bus for:

- external signs of damage
- foreign objects in the tyre tread
- foreign objects between twin tyres
- cracks, bulges



Danger.

Please note that cracks, bulges or external damage can cause a tyre to burst. This could result in you losing control of the bus and causing an accident, thereby injuring yourself and other people. Have damaged tyres replaced with new ones immediately.

Tyre age

Have the tyres changed at least every six years, irrespective of wear. This also applies for the spare wheel.



Danger.

The sun's rays and environmental factors cause tyres to age. The rubber from which the tyre is made loses elasticity. Tyres harden and become brittle, cracks appear due to ageing. Tyres which are more than six years old are no longer reliable.

Invisible tyre damage

Avoid crushing tyres against the kerb or switching off the bus when a part of the tyre tread is up on the kerb.



Danger.

Driving over the edge of the kerb or sharp edged objects can cause damage to the tyre substructure which is not visible externally. Damage to the tyre substructure only becomes noticeable much later and could cause the tyre to burst. This could result in you losing control of your bus and causing an accident, thereby injuring yourself and other people.

Tyre load capacity, top speed of tyres and types of tyres



Danger.

Exceeding the specified tyre load capacity or the approved maximum tyre speed could lead to tyre damage or tyre failure. You could then lose control of your bus and cause an accident, which could result in injury to yourself and others. For this reason, use only the tyre types and sizes approved for your bus model and observe the required tyre load capacity and speed index for your bus. Pay particular attention to country-specific tyre approval regulations. These regulations may specify a particular type of tyre for your bus or prohibit the use of particular tyre types that may be approved in other countries. In addition, it may be advisable to use a specific type of tyre in certain regions or areas of use. You can obtain information on tyres from any OMNIplus Service Partner.

Where twin tyres are fitted, the twin tyres must have the same external dia-

meter, otherwise the tyre that has the largest diameter will be overloaded. Tip: The simplest and most reliable measurement method is to check circumferences using a circumference tape.



Note:

















The maximum tolerance for twin tyres is 0.5% of the tyre diameter. The larger tyre must always be fitted in the outboard position.

Retreaded tyres

It is advisable to use only tyres and wheels that EvoBus has tested and approved specifically for your vehicle.

Tyre pressures table 295/80 R 22.5

Tyre pressures table 295/80 R 22.5

		[bar]	6,0	6,5	6,75	7,0	7,25	7,5	7,75	8,0	8,25	8,5	8,75	9,0
295 / 80 R 22,5	Michelin*		--	5560	5750	5950	--	6330	6520	6720	6910	7100		
			--	9880	10220	10560	--	11240	11580	11920	12260	12600		
	Continental		5375	5730	--	6080	--	6425	--	6775	--	7100		
			9535	10165	--	10785	--	11400	--	12000	--	12600		
	Dunlop		5370	5730	5900	6080	6260	6420	6590	6760	6930	7100		
			9540	10160	10480	10780	11110	11400	11700	12000	12300	12600		
	Semperit		5375	5730	--	6080	--	6425	--	6775	--	7100		
			9535	10165	--	10785	--	11400	--	12000	--	12600		
	Goodyear		5370	5730	5900	6080	6250	6420	6590	6760	6930	7100		
			9540	10170	10480	10790	11090	11400	11700	12000	12300	12600		
	Bridgestone		5370	5720	5900	6070	6250	6420	6590	6760	6930	7100		
			9530	10160	10470	10780	11090	11390	11700	12000	12300	12600		
	Firestone		--	5730	5900	6080	6250	6420	6590	6760	6930	7100		
			--	10170	10480	10790	11090	11400	11700	12000	12300	12600		
Fulda		--	5730	5900	6080	6250	6420	6590	6760	6930	7100			
		--	10170	10480	10790	11090	11400	11700	12000	12300	12600			

The numbers in the table show the respective axle load in kg. The table's first line gives the tyre pressure that is to be set in bar.

*

For Michelin tyres, also note: the tyre pressures at the front axle must be adjusted in accordance with the table value plus 1 bar, but to no more than a maximum of 8.5 bar.



Note:

The tyre pressures table shown here cannot be considered complete and is primarily provided for guidance only. The tyre catalogue of the manufacturer concerned is the decisive point of reference for the precise tyre pressures to be set in accordance with the current axle load.

On-screen tyre pressure monitor

The “Tyres” menu window is available in buses equipped with electronic tyre pressure monitoring.

The tyre pressure monitor is a convenience system designed to help you to check tyre pressures regularly and issues a warning if a tyre is overinflated or loses pressure.



Danger.

It is always your responsibility to ensure that the tyres are inflated to the correct pressure.



Note:

Tyre pressure increases or decreases by approximately 30 to 40 kPa (0.3 to 0.4 bar, 4.4 to 5.8 psi) with every 10 °C increase or decrease in air temperature respectively. Bear this temperature-related change in tyre pressure in mind if you are checking tyre pressures indoors and the temperature indoors is higher than the temperature outdoors. Example: Room

temperature is approximately 20 °C. Outside temperature is approximately 0 °C. In this case, the tyre pressure would be 60 to 80 kPa (0.6 to 0.8 bar, 8.7 to 11.6 psi) higher than the value specified in the tyre pressures table.

The tyre pressure monitor monitors the pressure in all tyres while the bus is stationary and while the bus is in motion.



Note:

The warnings issued by the tyre pressure monitor cannot be reliable unless the tyres have been inflated to the correct nominal pressure. The tyre pressure monitor would work with an incorrect value if, for example, your vehicle were overladen or laden incorrectly or if you were to fit wheels with a different tyre size to the vehicle and did not correct the nominal pressure in the on-board computer or entered an incorrect value. Refer to the tyre pressures table to check that the nominal pressure has been set correctly. An underinflated tyre would lead to instability while the bus is in motion and therefore an increased risk of accident.

Safety measures to be taken in the event of a flat tyre or a wheel change

Have the correct nominal pressure set in the on-board computer at a qualified specialist workshop.



Note:

If radio transmitting equipment (e.g. radio headphones, two-way radios) is being operated inside the bus or nearby, this could interfere with the correct functioning of the tyre pressure monitor. The display screen in the instrument cluster displays “- -” in place of the respective tyre pressure if a tyre pressure sensor is temporarily suffering interference, e.g. from radio transmitting equipment, or if the tyre pressure sensor has not yet supplied any values. Wait a few minutes and/or drive the vehicle away from the area affected by the radio transmitting equipment. The tyre pressure values shown on the display screen may differ from the readings obtained with an air pressure gauge. The tyre pressure displayed by the on-board computer relate to sea level. At higher locations, air pressure gauges display a higher tyre pressure than the display screen does. Do not reduce tyre pressure in this situation. The tyre pres-

sure monitor detects new wheels or new tyre pressure sensors automatically. Drive the bus for a few minutes at a speed of over approximately 18 mph (30 km/h).

Safety measures to be taken in the event of a flat tyre or a wheel change



Danger.

Park the bus as far away as possible from the traffic and on firm ground. Switch on the hazard warning lamps. Let all passengers disembark and move them out of the danger zone (e.g. behind the crash barrier). Position a warning triangle or hazard warning light at a suitable distance. Observe the legal requirements of the country concerned.



Danger.

Only change the wheel on a level, firm and non-slip surface. The bus or jack may slip out to the side on a soft or slippery surface (snow, ice, smooth surface, etc.).



Danger.

Never lie under the bus if it is raised up and is not supported by axle stands. Do not start the engine as there is a risk of fatal injury. Safeguard the engine against being switched on without authorisation. Remove the key from the ignition switch.

Fitting snow chains

► Snow chains



Note:

Comply with the manufacturer's fitting instructions and legal requirements.



Note:

Only RUD-MATIC MAXI chains are permitted.



Note:

Snow chains may be fitted more easily, especially on the rear axle, by raising the bus using the raising/lowering system.



Danger.

Make sure that the snow chains are fitted tightly. Do not exceed the permitted maximum speed of 25 mph (40 km/h).



Note:

Check the snow chains for firm seating after you have driven a certain distance (dependent on prevailing conditions) and retighten them if necessary.

Removing the spare wheel from the spare wheel cover

Removing the spare wheel from the spare wheel cover



M00_00-0084-01

- ▶ Pull handle (1) at the entrance of the front right door to open the front cover

i Note:

The spare wheel is located behind the front cover in the front end under the driver's station

i Note:

The openings below the spare wheel in the front compartment must not be sealed or covered by objects as trouble-free operation of the heating, ventilation and air-conditioning system would no longer be guaranteed.

The front cover opens forwards gently

i Note:

If the cover opens only a little, reach into the gap and pull the cover open

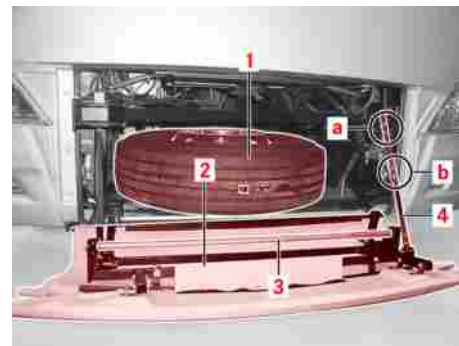

M40_00-0072-01

- ▶ Unhook retaining strap (4) from position (b) and hook back into position (a).

i Note:

Hold the spare wheel cover as you do this to avoid damage.

The spare wheel cover is now in the horizontal position and it is possible to pull the spare wheel out.

- ▶ Undo and remove the spare wheel retaining strap

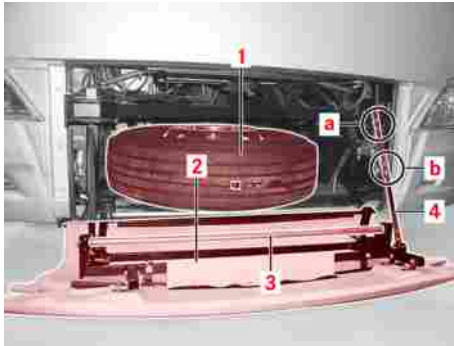

M40_00-0072-01

- ▶ Pull spare wheel (1) forwards over roller bar (3)

Positioning the jack

- ▶ Observe the safety precautions.



Danger.

Follow the jack manufacturer's instructions.



Danger.

Either a 10 t jack or a 5 t and a 10 t jack are on the bus depending upon the bus type. Use in accordance with intended use.



Danger.

Secure the bus against rolling away (apply the parking brake). Also chock at least one front wheel if there is a defective wheel on the rear axle.

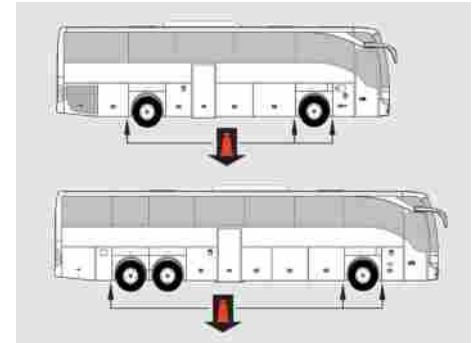

M00_00-0497-71

- ▶ Positioning the jack



Danger.

The jacking points on the skeleton are marked on the outside of the bus by a jack symbol. Make sure that you follow the instructions in the relevant section of this manual for positioning the jack when changing a wheel.

Removing the wheel nut cover or wheel trim (option)



Danger.

In order to prevent damage to the skeleton, jacks should be positioned at the designated jacking points only. If axle stands are not available, the good spare wheel or the defective wheel must be positioned at a suitable position under the body for the duration of the wheel fitting/removal procedure to provide protection in case the jack should fail.

Removing the wheel nut cover or wheel trim (option)



Danger.

Risk of accident. Secure the bus against rolling away. Switch off the ignition and remove the key. Risk of injury. Take particular care around hot, rotating and moving parts.

Removing the wheel nut cover

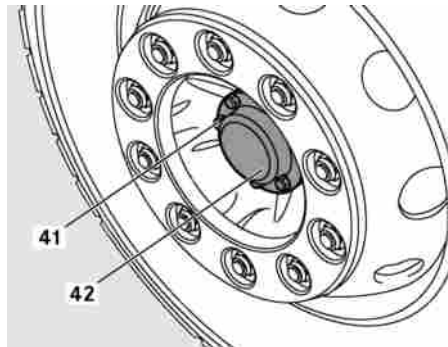

W40_20-0057-01

- ▶ The wheel nut cover cap (1) is fastened to the wheel by two wheel

nuts. Slacken and remove these two wheel nuts.

- ▶ Remove the wheel nut cover cap (1).

Removing the wheel trim (option)

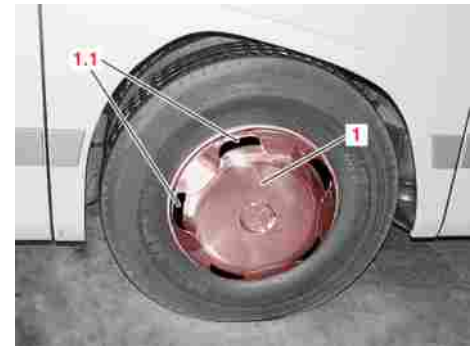

M40_00-0007-01

- ▶ Reach into ventilation openings (1.1) in wheel trim (1) with both hands.

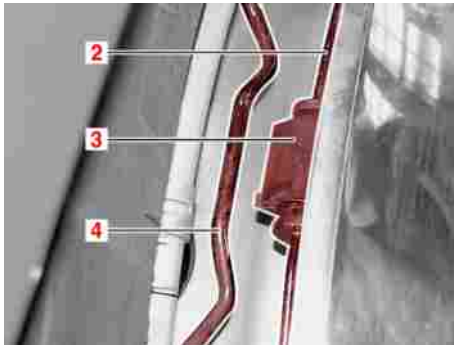

M40_00-0008-01

- ▶ After you have reached into the wheel trim, firstly detach clamp ring (2) from retaining clip (3). This reduces the compression force on clamp ring (4) and the wheel trim can be removed more easily.

Removing the wheels

Removing a front wheel



M40_00-0084-71

- ▶ Place a ramp at the defective wheel and drive the bus onto it

Note:

If the ground is very slippery and hard, the ramp may slide out from under the wheel when the bus is driven onto it. Make sure you follow the instructions on the ramp instruction plate.

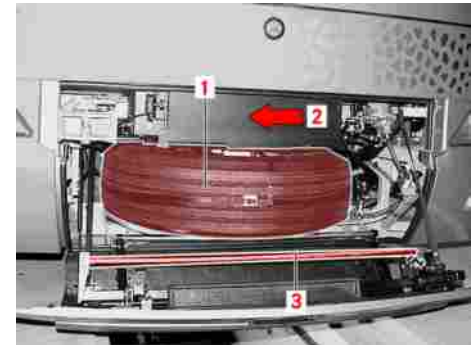

M40_00-0023-01

- ▶ Loosen the wheel nuts using the wheel nut wrench from the vehicle tool kit.

Note:

Roller bar (3), over which the spare wheel is pulled from the spare wheel cover, can be used as an extension. It can be pulled out of the retaining bracket after the spring clip has been removed.

Removing the wheels



M40_00-0011-01

- ▶ Place the telescopic jack (10 t) on a laminated wood base and jack up the bus at the control arm jacking point (arrowed)

Organisational resource

Telescopic jack (10 t)

Tools to be self-made

Laminated wood base



Note:

Extend the telescopic jack the maximum distance so that there is a gap between the wheel and the ramp



Danger.

If axle stands are not available, the spare wheel or the defective wheel must be positioned at a suitable position under the body for the duration of the tyre change to provide protection in case the jack should fail.

- ▶ Remove the ramp
- ▶ Unscrew and remove all wheel nuts apart from three offset to one another
- ▶ Do not unscrew the last three wheel nuts until you have checked that the wheel is seated on the wheel bolts without tension
- ▶ Take off the defective wheel



Caution:

When you remove the wheel you must make sure that the wheel is not pulled over the threads on the wheel bolts. This would damage the bolt threads and make it difficult to screw on the wheel nuts. In the worst case the wheel nut could seize on the damaged wheel bolt.

Removing a wheel from the driven axle



M40_00-0012-01

- ▶ Place a ramp at the good wheel of the twin tyres and drive the bus onto it

Organisational resource

Telescopic jack (10 t)

Tools to be self-made

Laminated wood base



Note:

Extend the telescopic jack the maximum distance so that there is a gap between the wheel and the ramp



Danger.

If axle stands are not available, the spare wheel or the defective wheel must be positioned at a suitable position under the body for the duration of the tyre change to provide protection in case the jack should fail.

- ▶ Remove the ramp
- ▶ Unscrew and remove all wheel nuts apart from three offset to one another
- ▶ Do not unscrew the last three wheel nuts until you have checked that the



Note:

If the ground is very slippery and hard, the ramp may slide out from under the wheel when the bus is driven onto it. Make sure you follow the instructions on the ramp instruction plate.

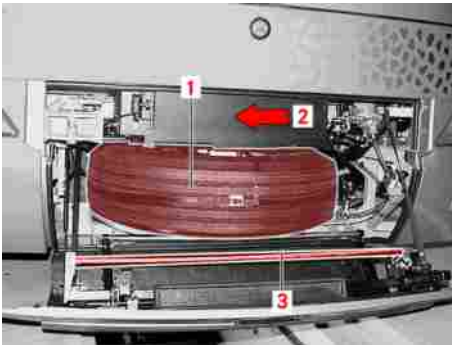

M40_00-0023-01

- ▶ Loosen the wheel nuts using the wheel nut wrench from the vehicle tool kit.



Note:

Roller bar (3), over which the spare wheel is pulled from the spare wheel cover, can be used as an extension. It can be pulled out of the retaining bracket after the spring clip has been removed.

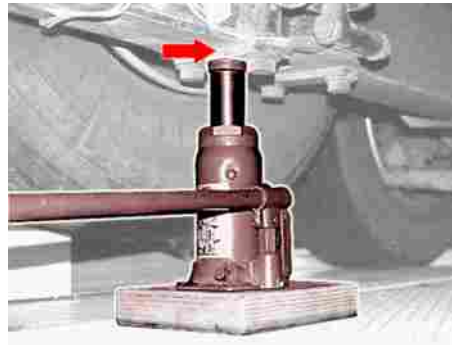

M40_00-0013-01

- ▶ Place the telescopic jack (10 t) on a laminated wood base and jack up the bus at the jacking point (arrowed)

Removing the wheels

wheel is seated on the wheel bolts without tension

- ▶ Take off the defective wheel



Caution:

When you remove the wheel you must make sure that the wheel is not pulled over the threads on the wheel bolts. This would damage the bolt threads and make it difficult to screw on the wheel nuts. In the worst case the wheel nut could seize on the damaged wheel bolt.

Removing a wheel from the trailing axle



M40_00-0014-01

- ▶ Drive the defective wheel onto ramp (1)



Note:

If the ground is very slippery and hard, the ramp may slide out from under the wheel when the bus is driven onto it. Make sure you follow the instructions on the ramp instruction plate.

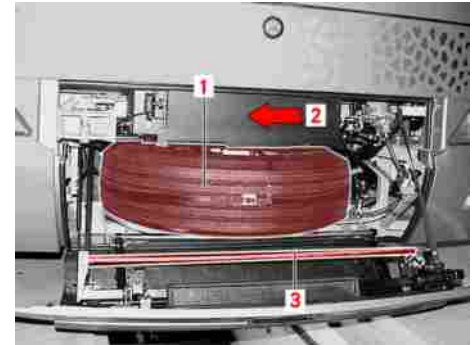

M40_00-0023-01

- ▶ Loosen the wheel nuts using the wheel nut wrench from the vehicle tool kit.



Note:

Roller bar (3), over which the spare wheel is pulled from the spare wheel cover, can be used as an extension. It can be pulled out of the retaining bracket after the spring clip has been removed.

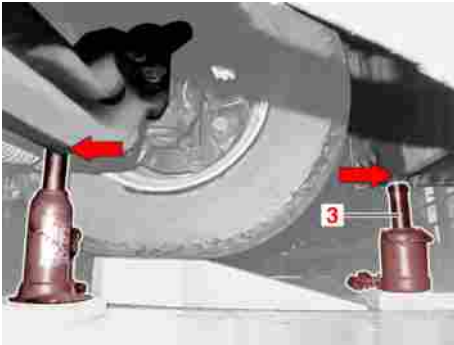

M40_00-0021-01

- Firstly fully jack up the body with the telescopic jack (10 t) (3) at the jacking point to the rear of the trailing axle so that the trailing axle is not overloaded.

Organisational resource

Telescopic jack (10 t)



If axle stands are not available, the spare wheel or the defective wheel must be positioned at a suitable position under the body for the duration of the tyre change to provide protection in case the jack should fail.

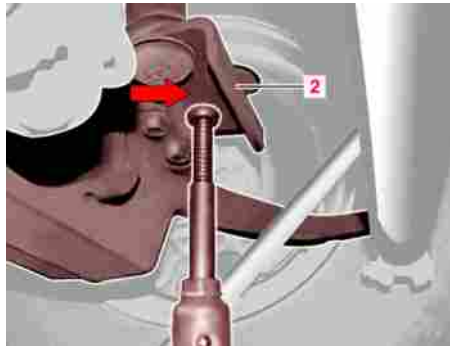

M40_00-0015-01

- Then raise the trailing axle by the shock absorber mounting plate (2) using a screw-type jack (5 t) until the defective wheel is relieved of load.

Organisational resource

Telescopic jack (5 t)



The trailing axle must not be laden with the weight of the bus.

- Remove the ramp
- Unscrew and remove all wheel nuts apart from three offset to one another
- Do not unscrew the last three wheel nuts until you have checked that the wheel is seated on the wheel bolts without tension.
- Take off the defective wheel



When you remove the wheel you must make sure that the wheel is not pulled over the threads on the wheel bolts. This would damage the bolt threads and make it difficult to screw on the wheel nuts. In the worst case the wheel nut could seize on the damaged wheel bolt.

Fitting the spare wheel

Fitting the spare wheel

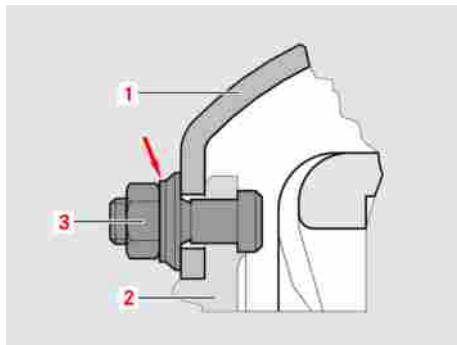

M40_00-0016-01



Caution:

Where necessary, remove rust and dirt from the contact surfaces on the wheel, wheel hub, centring lugs and wheel nuts.



Danger.

The thread of the wheel bolts and wheel nuts must be free of oil and grease. Degrease the thread if necessary.

- ▶ Fit the spare wheel



Danger.

If the bus is equipped with pressed-steel wheels, the spare wheel to be fitted must also be a pressed-steel wheel. Similarly, an aluminium disc wheel must be fitted during a wheel change if the bus is equipped with aluminium disc wheels. Light-alloy wheels and pressed-steel wheels require a different type of wheel nut.



Note:

Disc wheels (1) are centred by the centring lugs on hub (2).

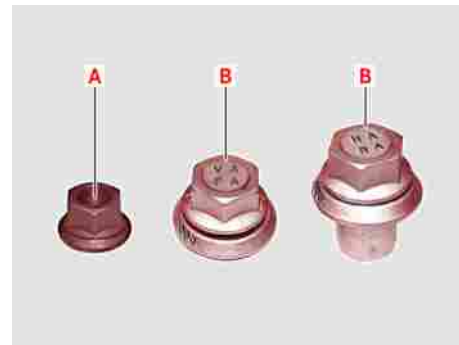

M40_00-0053-01

- ▶ Fit the wheel nuts and screw them on into contact with the wheel.



Danger.

Note the different flat collar nuts. A: Wheel nuts for pressed-steel wheels (steel rims) do not have any marking, B: Wheel nuts for aluminium wheels (aluminium rims) bear the inscription “VA FA” for single tyres, “HA RA” for twin tyres and a marking with 3 rings on the integral thrust washer (see illustration).



Danger.

Always select the correct nuts for the type of wheel concerned.



M40_00-0061-01

- ▶ For vehicles with light-alloy wheels (aluminium rims), slide the assembly sleeves (vehicle tool kit) over 2 opposing wheel bolts to avoid damage during removal and refitting.
- ▶ Place the ramp back under the wheel, lower the bus and take the jack away.



Note:

If you do not push the ramp under the wheel, it will not be possible to remove the jack.

- ▶ Tighten the wheel nuts in a crosswise pattern

Tightening torque

Wheel nuts: 600 Nm



Danger.

Tighten the wheel nuts using the available tool and drive cautiously to the nearest OMNIplus Service Partner. Have the wheel nuts tightened to the specified torque.



Danger.

If you use an impact wrench, tighten the wheel nuts only slightly in a crosswise pattern first and then tighten the nuts to the specified torque using a torque wrench.

- ▶ Drive the bus off the ramp



Danger.

The wheel nuts must be retightened after the bus has covered 50 km.

Fitting the wheel nut cover or wheel trim (option)

Fitting the wheel nut cover or wheel trim (option)



Danger.

Risk of accident. Secure the bus against rolling away. Switch off the ignition and remove the key. Risk of injury. Take particular care around hot, rotating and moving parts.



Note:

Before fitting the wheel nut cover, clean the contact surfaces on the wheel nut cover, wheel and wheel nut of any rust and dirt.

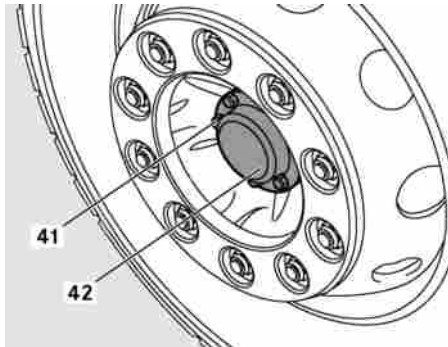

W40_20-0057-01

- ▶ Place wheel nut cover (1) over the wheel bolts.
- ▶ Screw the wheel nuts onto the wheel bolts and move the wheel nut cover into full contact with the wheel.
- ▶ Tighten the wheel nuts to the specified torque in a crosswise pattern and in a number of passes.

Tightening torque

Wheel nuts for steel rims: 600 Nm

Tightening torque

Wheel nuts for aluminium rims: 600 Nm

Fitting the wheel trim (option)

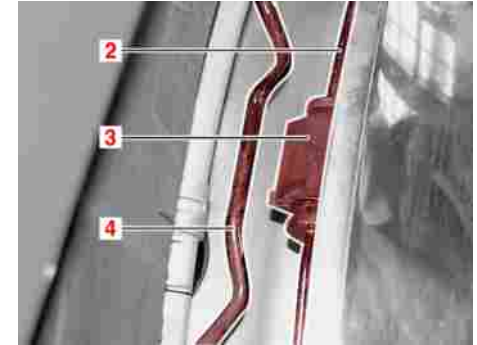

M40_00-0008-01

- ▶ Place the wheel trim on the clamp ring (4). When you do this you should insert the retaining clip lugs (3) of the wheel trim into the clamp ring cut-out (4). Attach the lower retaining clips and press on. Then press the wheel trim into the other retaining clips.

Inflating tyres using the tyre inflator connection (option)



Danger.

Make sure that the wheel trim is seated correctly. All retaining clips (3) must be fixed behind clamp ring (4).

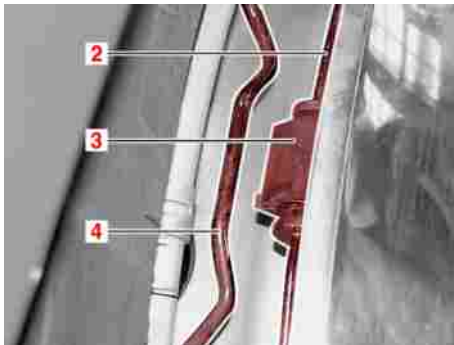

M40_00-0008-01

- ▶ Push in the last top retaining clips with the clamp ring detached. This considerably reduces the amount of force required and you also avoid the possibility of damaging the wheel trim. After you have fitted the wheel trim, reach into the ventilation openings and hook clamp ring (2) into retaining clip (3) again. The retain-

ing clips must not rest on a balance weight.

Inflating tyres using the tyre inflator connection (option)

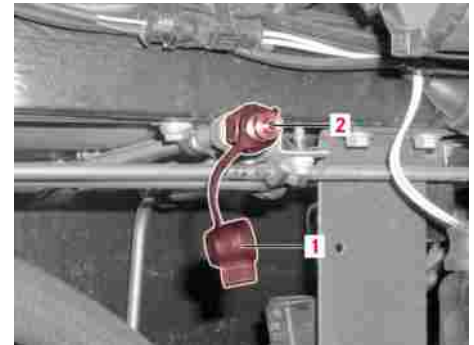

M40_00-0078-71

- ▶ Remove protective cap (1) from tyre inflator connection (2)



Note:

When the engine is running, a pressure up to 12 bar (pressure regulator cutoff pressure) can be drawn off. Compressed air cannot be drawn off unless the pressure regulator is in the fill position. If the pressure regulator has switched off (idle position - blows into the open air), the pressure must be reduced using the

Inflating tyres using the tyre inflator connection (option)

pedal-operated brake valve until the pressure regulator switches on again.



Caution:

Since the pressure in the system may be too high for inflating a tyre, the inflation procedure should be monitored by observing the compressed-air reservoir pressure operating display on the instrument cluster screen.

- ▶ Pump air out of the compressed-air system (using the pedal) until the reservoir pressure for circuits 1 and 2 indicated by the reservoir pressure operating display drops below 6.5 - 7 bar.

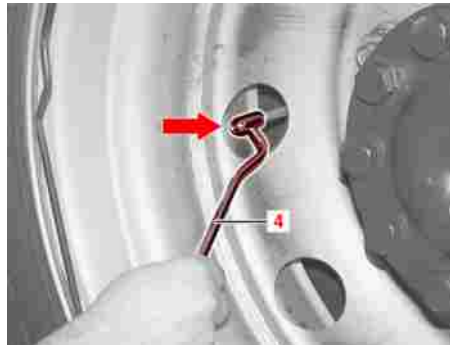

M40_00-0020-01

- ▶ Screw on valve connector (4), if not already fitted, to the other end of the tyre inflation hose using the wing nut.

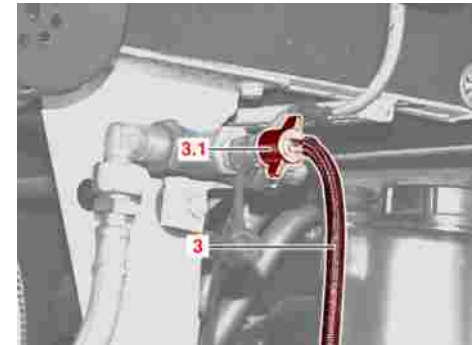

M40_00-0019-01

- ▶ Screw tyre inflation hose (3) onto the tyre inflator connection to the stop using the wing nut (3.1).



Note:

Position the hose so that the engine compartment flap can be closed.

- ▶ Unscrew the protective cap from the tyre valve and connect valve connector (4).
- ▶ Close the engine compartment flap
- ▶ Start the engine and fill the tyres up to the specified pressure (approx-

Inflating tyres using the tyre inflator connection (option)

imately 8.5 bar), then switch off the engine.



Note:

Observe the operating display for reservoir pressure circuits 1 and 2.

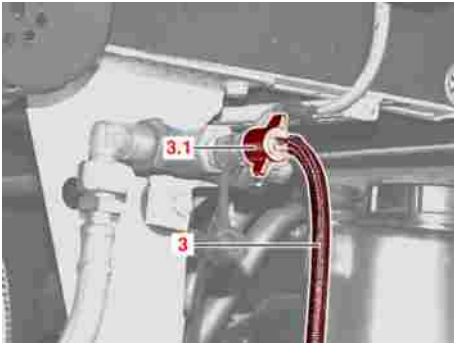

M40_00-0019-01

- ▶ After you have finished pumping up the tyres, unscrew tyre inflation hose (3) and seal the tyre inflator connection with the rubber cap.



Danger.

Never drive the bus when the tyre inflation hose is connected.



Danger.

Pump up the tyres to the specified pressure at the next opportunity.

Practical advice

Pneumatic system test ports under the driver's area

Pneumatic system test ports under the driver's area

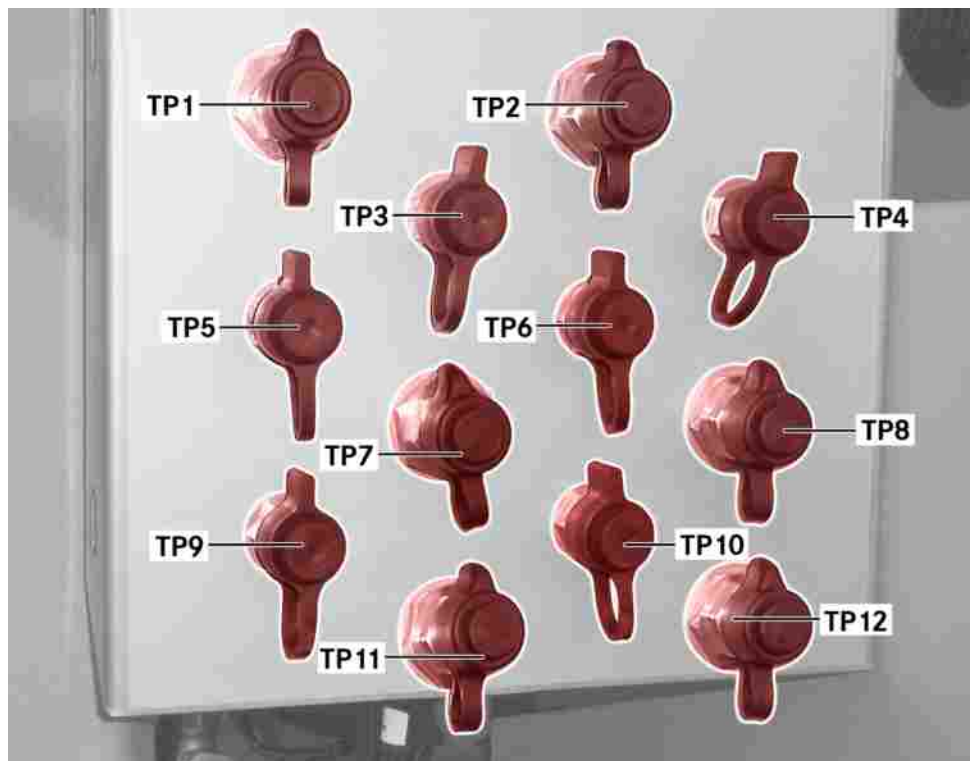

Pneumatic system test ports under the driver's area

	Pneumatic test ports (behind the left-hand service cover under the driver's area).	TP 12	<i>Suspension supply pressure</i>
TP 1	<i>Auxiliary consumers supply pressure</i>		
TP 2	<i>Spring-actuated parking brake supply pressure</i>		
TP 3	<i>Front axle brake supply pressure</i>		
TP 4	<i>Driven axle brake supply pressure</i>		
TP 5	<i>Brake pressure regulated on the left-hand side of the front axle</i>		
TP 6	<i>Brake pressure regulated on the right-hand side of the front axle</i>		
TP 7	<i>Spring-actuated parking brake control pressure</i>		
TP 8	<i>Spring-actuated parking brake emergency release control pressure</i>		
TP 9	<i>Driven axle brake pressure (redundancy)</i>		
TP 10	<i>Not assigned</i>		
TP 11	<i>Not assigned</i>		

Practical advice

Pneumatic test ports behind door 2

Pneumatic test ports behind door 2



Pneumatic test ports (behind the right-hand luggage compartment flap to the front of the driven axle).

- TP 13 Brake pressure regulated on the right-hand side of the driven axle*
- TP 14 Brake pressure regulated on the right-hand side of the trailing axle (only on buses with third axle)*

Other pneumatic test ports

Other pneumatic test ports

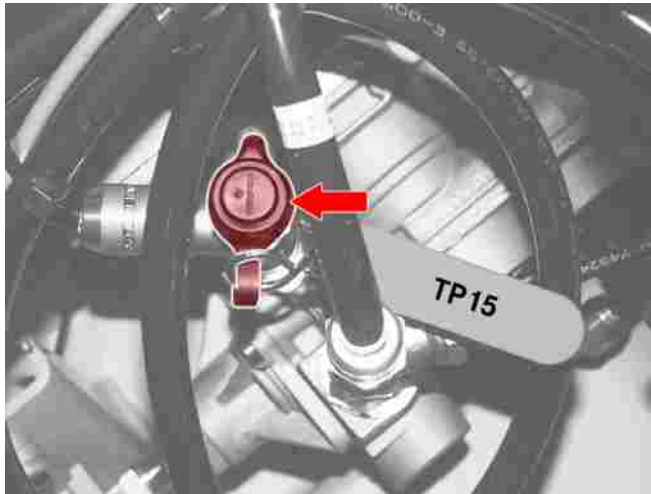

Charging the compressed-air system of another bus (option)

- TP 15 Brake pressure regulated on the left-hand side of the driven axle (at the axle modulator of the driven axle, port 21)
- Door 2 Pneumatic test port

i **Note:**

This test port is located on the door valve in the step of the doorway of door 2.

Charging the compressed-air system of another bus (option)

i **Note:**

Compressed air cannot be drawn off unless the pressure regulator is in the fill position.

- ▶ If the pressure regulator has been deactivated (idle position - blows into the open air), reduce the pressure in the compressed-air system by operating the pedal-operated brake valve until the pressure regulator switches on again (charge position).



M42_00-0104-01

- ▶ Charging hose (1) can be used to fill the compressed-air system of another bus via tyre inflator connection (4), which is located in the engine compartment.

! **Danger.**

The bus must not be driven under any circumstances if the charging hose is still connected.

Charging the compressed-air system of another bus (option)

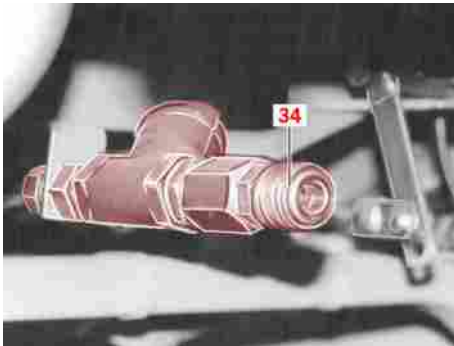

M42_00-0105-01

- Filling via nipple connector



Note:

Optional equipment 1: compressed-air connection via nipple connector (1/2") (34) behind the front flap and in the engine compartment

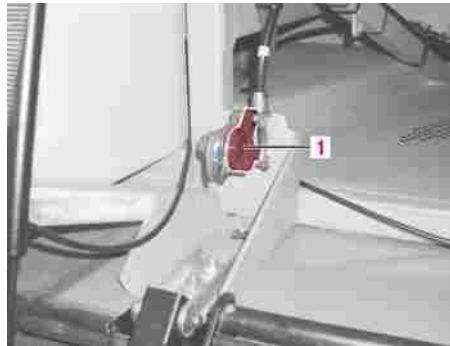

M42_00-0326-01

- Filling via coupling head



Note:

Optional equipment 2: compressed-air connection via coupling head (1) behind the front cover and in the engine compartment.



Note:

The bus concerned can be filled or the compressed-air system of a 2nd bus supplied with compressed air using an adapter hose suitable for the existing connections.



Caution:

Do not fill the compressed-air system of the 2nd bus beyond the cutoff pressure of the pressure regulator fitted to this bus.

Operating the bus stop brake/drive-off lock emergency release switch (option)

Operating the bus stop brake/
drive-off lock emergency release
switch (option)



Danger.

This switch has a tamper-evident seal and is intended to be operated only in the event of a malfunction in the bus stop brake or drive-off lock.

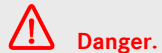

Danger.

Make absolutely sure that the parking brake is applied before you operate the bus stop brake emergency release switch. The bus could otherwise roll away.

- ▶ Remove the tamper-evident seal from the emergency valve.



M42_00-0595-71

- ▶ Fold open red cover (1) of the emergency valve.
- ▶ Press the switch.



The bus stop brake/drive-off lock function is no longer active.



Note:

This symbol appears on the instrument cluster display screen.



Danger.

Have the malfunction rectified as soon as possible by an OMNIplus Service Partner.

Operating/malfunction displays: steering system

Operating/malfunction displays: steering system

Steering hydraulics oil level too low (only on buses with electronic oil level detection)



If the oil level in the steering hydraulics expansion tank is too low, this icon will be displayed on the screen in conjunction with a yellow alert.



Danger.

Have the bus checked immediately by an OMNIplus Service Partner.

RAS system pressure too low (3-axle buses only)



A yellow alert together with this icon will be displayed on the screen if the pressure in the additional RAS trailing axle steering system is too low.



Danger.

Have the bus checked immediately by an OMNIplus Service Partner. Avoid reversing. There is a risk of damage to the trailing axle or suspension from the wheels turning uncontrollably. Drive carefully and straight-ahead as the trailing axle no longer has a stabilising effect.

Bleeding the fuel system using the electric fuel pump (option)

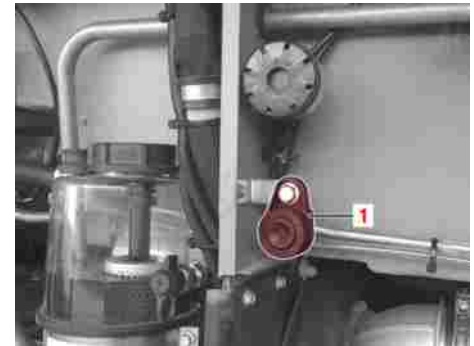

M47_00-0121-71

- ▶ The electric fuel pump can be used to bleed the fuel system. Press button (1) briefly to switch on the electric fuel pump. The pump will switch off after 85 seconds.
- ▶ Start the engine and check the fuel system for any leaks that may still be present.

Replacing the water heater fuel filter

Replacing the water heater fuel filter



Danger.

Risk of explosion from ignition of fuel, risk of poisoning from inhalation and swallowing of fuel as well as risk of injury if fuel comes into contact with skin and eyes.

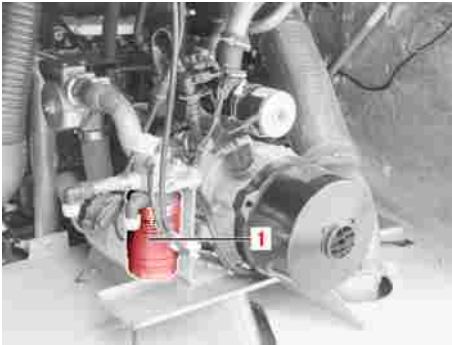

M47_00-0052-01

- ▶ Close the fuel feed shut-off valve (above the filter), if fitted.
- ▶ Place a container underneath.



Note:

Make sure that the water heater cannot be switched on.

- ▶ Loosen and remove filter cartridge (1).



Environmental protection

Dispose of the filter cartridge in an environmentally responsible manner.

- ▶ Lightly oil the sealing ring of new filter cartridge (1).
- ▶ Fill filter cartridge (1) with diesel fuel and screw it back on.
- ▶ Screw it on hard by hand.



Note:

Do not use any form of tool.

- ▶ Switch on the water heater and check for leaks and correct operation.

Electrical system safety precautions



M54.00-2004-71

For safety reasons, always switch off the battery isolating switch (01S01) before work is carried out on the electrical system or the batteries are disconnected/reconnected.

Do not connect or disconnect wiring harness connectors to/from electronic control units unless the ignition starter switch is OFF.

During engine washes, always protect the starter, alternator and electrical plug connections from moisture.

Never attempt to bridge or repair fuses.

General safety precautions for batteries

Use only fuses of the specified amperage. Never replace fuses with those of a higher ampere rating as this could lead to damage to the electrical system.

General safety precautions for batteries



Danger.

Risk of short circuit. Do not place any metal objects on batteries.



Caution:

Do not loosen or disconnect the terminals when the engine is running and electrical equipment is switched on.



Environmental protection

Dispose of defective batteries in an environmentally responsible manner. Observe legal requirements.

Safety precautions for handling batteries



M54_10-0004-01

- 1 - Fire, sparks, naked flames and smoking are forbidden. Prevent sparking.
- 2 - Risk of explosion.
- 3 - Observe the operating instructions.
- 4 - Risk of acid burns. Battery acid is corrosive. Always observe the safety instructions and safety precautions when handling batteries or battery acid. Battery acid must never come into contact with skin, eyes or clothing. Rinse off all acid splashes immediately with copious

Measures required for the prevention of damage to buses or components during electric welding work

amounts of clean water. Seek medical attention if necessary.

5 - Wear safety goggles.

6 - Keep children away.



Danger.

Naked flames and smoking are strictly forbidden whenever work is being carried out on the vehicle batteries. Avoid the creation of sparks. Wear safety goggles. Keep children away. There is a risk of acid burns. The Operating Instructions must be observed. There may be a risk of explosion.

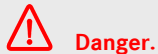

Danger.

Only lead-acid batteries are permitted to be fitted, never gel batteries. All cells of the batteries must be fitted with special caps that are interlinked by vent hoses, thereby allowing any gases produced to be directed into the open air.

Measures required for the prevention of damage to buses or components during electric welding work

To prevent damage to various components of the bus, the following measures must be taken before undertaking welding work:

- Have a fire extinguisher on standby.
- The clip on the negative terminal of the battery must be disconnected and the negative terminal covered. (Observe the notes on disconnecting the vehicle batteries.)
- The pieces of foam fitted in some of the cavities in the body as sound-proofing must be removed before the commencement of panel work, welding and tin-plating.
- Connect the earth connection of the electric welder directly to the part to be welded. When doing so, make sure that there are no electrically insulating parts between the earth connection and the weld point.
- Heat-sensitive parts, such as plastic tubes, are to be protected or removed.
- Lines routed in cavities, and containers or electronic components that have been fitted concealed, must be removed from the danger area before the start of welding.
- The passenger compartment and glazing must be covered with protective mats to protect them from weld splatter and flying sparks.
- Shield off areas at risk of damage caused by flying sparks and radiant heat.
- Do not allow electronics housings or electrical lines to come into contact with the welding electrode or the earth connection of the welder.
- If two parts are to be welded together, both parts must be connected to the negative clip of the welder.
- The seam points of the part on the bus to be welded and of the earth terminal on the electric welder must be as bare as possible – paint, cor-

Measures required for the prevention of damage to buses or components during electric welding work

rosion, oil, grease and dirt should therefore be thoroughly removed.

- The earth terminal of the welder must not be connected to the transmission. The welding current may cause sparking at the bearing points inside the transmission. The resultant changes in crystalline structure would lead to premature failure of the assembly.



Danger.

The heating effects may cause dense smoke or fires.

Practical advice

Electrical system (illustration shows 15 RHD as an example)

Electrical system (illustration shows 15 RHD as an example)

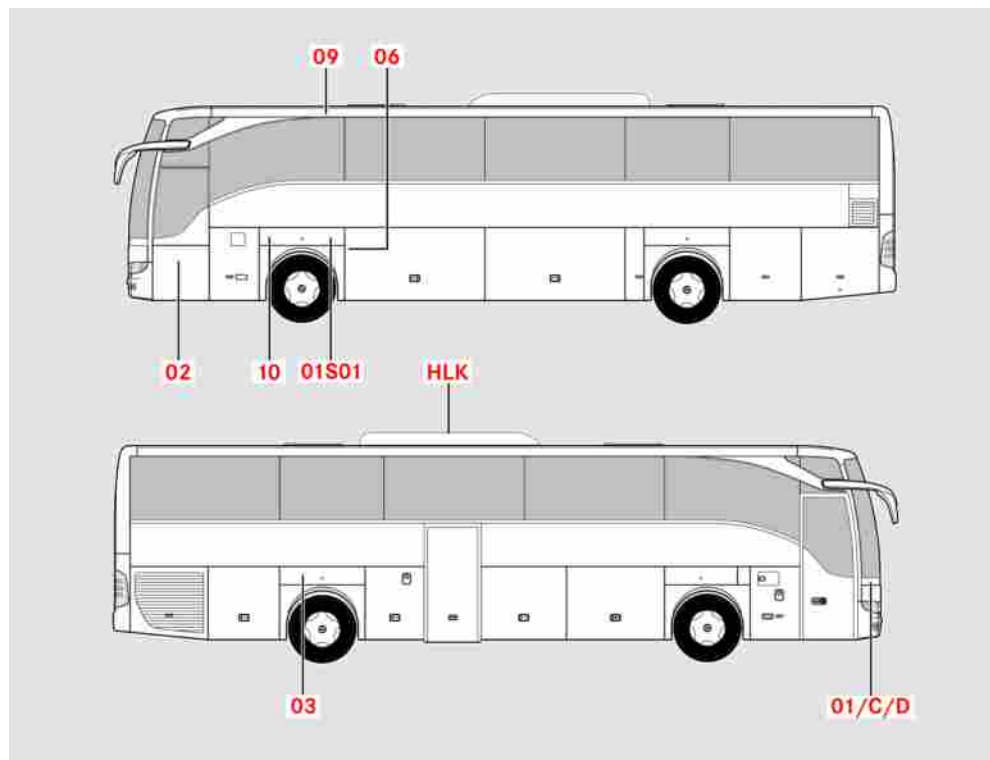

Electrical system (illustration shows 15 RHD as an example)

01/C/D Driver's area interior switch panel, diagnostics connection, socket for download and self-healing, electrical system vehicle data CD



Note:

A detailed layout of electrical components (control units, fuses, relays and connectors, etc.) can be found on the electrical system vehicle data CD.

01S01 Battery isolating switch



Note:

On the 16 RHD (2-axle bus), the battery isolating switch is located on the auxiliary switch panel on the right-hand side above the driven axle when viewed in the direction of travel.

02 Main switch panel (under the driver's area)

03 Auxiliary switch panel



Note:

On the 16/17 RHD (3-axle bus) on the right-hand side at the rear above the trailing axle.

HVAC

Electrical connection for the roof-mounted system (heating, ventilation, air-conditioning)

06

Fuse switch panel (PDB)



Note:

On the 16 RHD (2-axle bus), the fuse switch panel (PDB) is located on the auxiliary switch panel on the right-hand side above the driven axle when viewed in the direction of travel.

09

Ceiling switch panel

10

Battery compartment



Note:

On the 16 RHD (2-axle bus), the batteries are located to the rear of the driven axle on the right-hand side when viewed in the direction of travel.

Practical advice

Battery isolating switch (with switch-off authorisation LED)

Battery isolating switch (with
switch-off authorisation LED)



- 01S01 Battery isolating switch
1 Switch-off authorisation LED

**Caution:**

If this LED is lit, it is prohibited to turn the battery isolating switch to the “OFF” position. Otherwise, the exhaust gas aftertreatment system could be damaged.

**Note:**

Similarly, the battery isolating switch should not be turned to the “OFF” position with the anti-theft alarm system (option) primed as this would trigger an alarm.

**Note:**

Battery isolating switch (01S01) is located in the battery compartment.

Driver's area interior switch panel

Driver's area interior switch panel

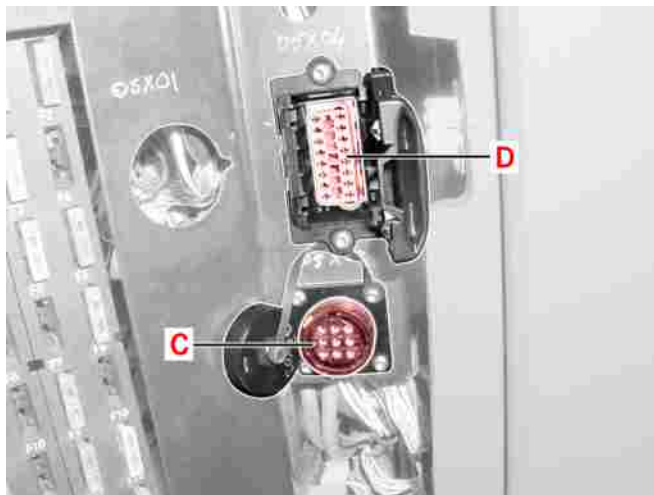

- C Socket for FPS download and self-healing (flexibly programmed controller)
- D Diagnostics socket

**Note:**

This switch panel also houses fuses for consumers in the front section of the bus.

**Note:**

The cover of the driver's area control panel also houses the electrical system vehicle data CD. This CD must remain in the bus since it contains important bus-specific data necessary for maintenance and service work.

Practical advice

Main switch panel (under the driver's area)

Main switch panel (under the driver's area)

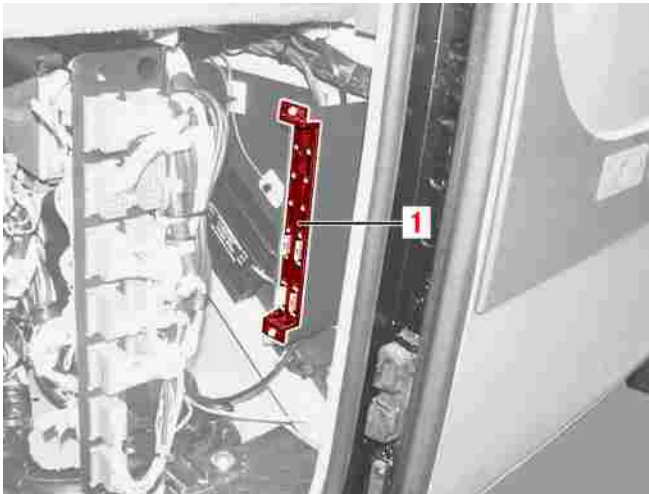

**Note:**

Various electronic control units such as the EBS, retarder, etc., are located here. Various fuses (1) are also found here.

Auxiliary switch panel

Auxiliary switch panel

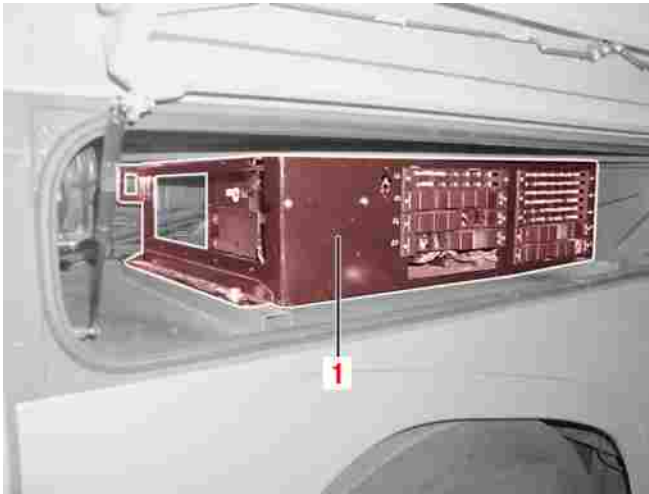



Note:

Auxiliary switch panel (1) also houses fuses for consumers in the rear section of the bus. The auxiliary switch panel is located above the driven axle or the trailing axle on the right-hand side.

PDB fuse switch panel

PDB fuse switch panel

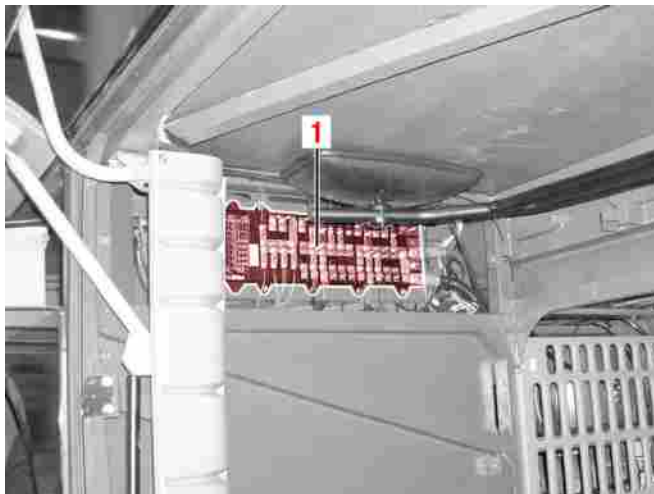

**Note:**

The PDB (Power Distribution Board) fuse switch panel (1) accommodates main fuses and various other fuses including those for the flexibly programmed controller system. Fuse switch panel (1) is located behind a cover in the luggage compartment to the rear of the front axle on the left-hand side when viewed in the direction of travel.

**Note:**

On the 16 RHD (2-axle bus), the fuse switch panel is located on the auxiliary switch panel on the right-hand side above the driven axle when viewed in the direction of travel.

Ceiling switch panel

Ceiling switch panel





Note:

There are also various fuses located on the ceiling switch panel for consumer units in the ceiling. This is located in the ceiling duct on the front left.

Practical advice

Electrical connection for the roof-mounted system (heating, ventilation, air-conditioning)

Electrical connection for the roof-mounted system (heating, ventilation, air-conditioning)

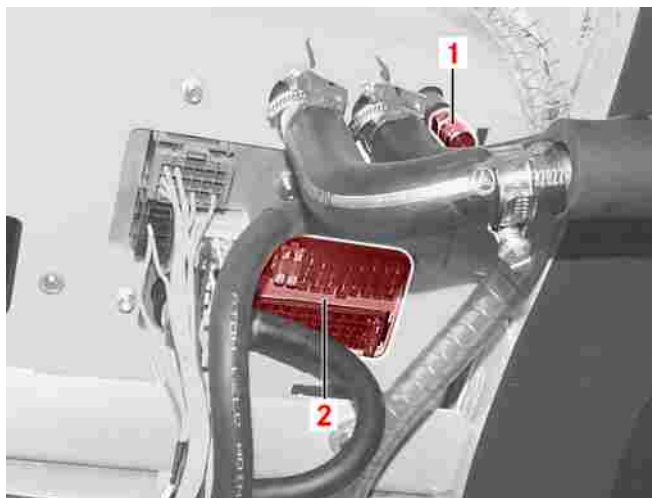

Electrical connection for the roof-mounted system (heating, ventilation, air-conditioning)

**Note:**

The electrical connection for the roof-mounted system is located on the right-hand side in the area above door II or above the on-board kitchenette. This area is only accessible from the passenger compartment.

**Note:**

Various consumers of the roof-mounted system, such as the condenser blowers, passenger compartment blowers, etc., are protected by the fuses here (2).

Battery compartment

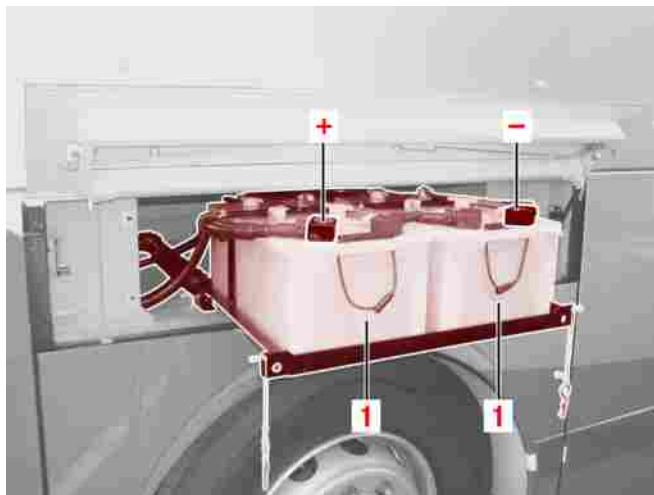

**Note:**

The battery compartment is found at the front on the left above the front axle.

**Note:**

On the 16 RHD (2-axle bus), the batteries are located to the rear of the driven axle on the right-hand side when viewed in the direction of travel.

Notes on fuse assignments

The following information in respect of fuse assignments should be observed:

**Note:**

This description is based on the standard assignment of fuses in the bus. Bus-specific assignment may differ from bus to bus. Not all fuse slots necessarily have to be assigned on every bus. Furthermore, fuses may occupy unassigned slots because they are protecting special customer options or retrofitted equipment, for example.

**Note:**

The bus-specific fuse assignment and fuse ratings can be found on the vehicle data CD located in the driver's area interior switch panel.

Practical advice

Fuse assignment for the driver's area interior switch panel, Tourismo RHD

Fuse assignment for the driver's area interior switch panel, Tourismo RHD

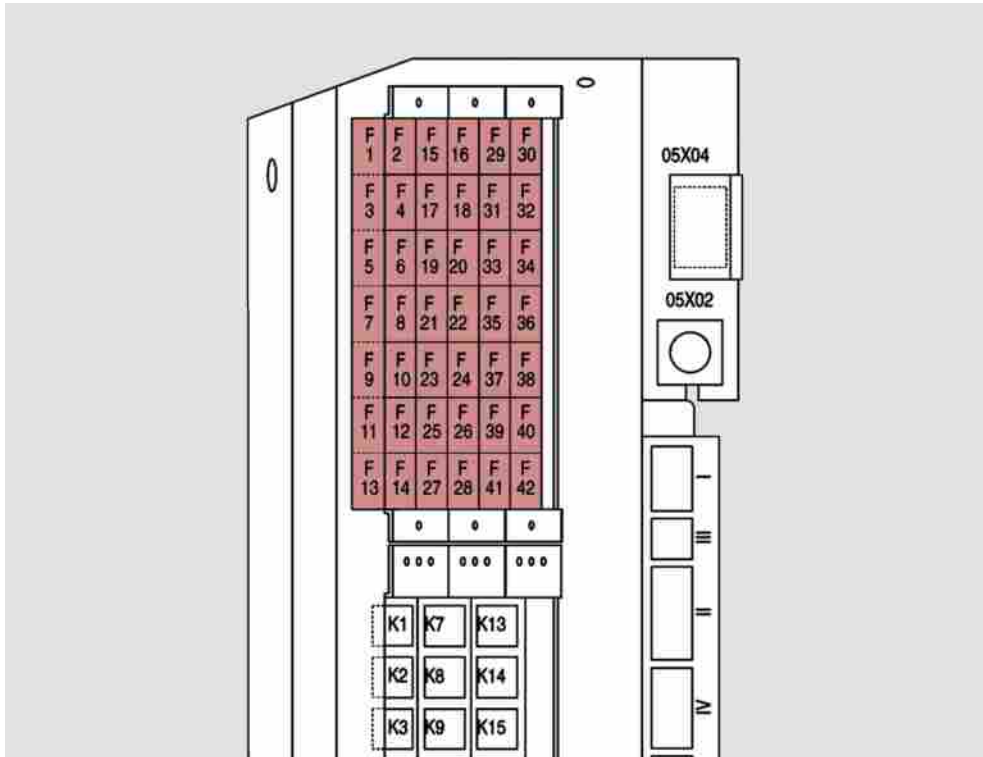

Fuse assignment for the driver's area interior switch panel, Tourismo RHD

F1	7.5 A - Co-driver's reading lamp (31F01)	F16	3 A - Recording system, general (65F07)	F29	3 A - Recording system, general (65F06)
F2	7.5 A - Mirror adjustment (32F05)	F17	15 A - Throttle valve (17F08)	F30	15 A - Heating for fuel filter (15F34)
F2a	15 A - Front coldbox (80F06)			F31	7.5 A - Door 1 door control (41F06)
F3	7.5 A - Radio (audio) system (70F01)			F32	7.5 A - Accident data recorder (60F05)
F4	7.5 A - Lavatory inverter (80F34)	F18	7.5 A - Accident data recorder (60F06)	F33	15 A - 24 V socket (02F07)
F5	7.5 A - Power supply switch (61F01)	F19	15 A - Driver's power window (32F09)	F34	15 A - 24 V/12 V voltage converter (01F18)
F6	15 A - Driver's seat (81F01)	F20	7.5 A - Driver's seat vibration motor supply (81F06)	F35	15 A - 12 V socket (02F08)
F7	7.5 A - Intercom (72F18)	F21	7.5 A - Distance sensor (10F28)	F36	7.5 A - Engine warning/malfunction indicator lamp (10F39)
F8	7.5 A - Download/diagnostics (05F01)	F22	7.5 A - Door 1 doorway lighting (41F04)	F37	15 A - Intercom system (70F20)
F9	7.5 A - Charge line 2 battery (02F28)	F23	3 A - Attendant call system (83F01)	F38	15 A - Heating/ventilation/air-conditioning HVAC (50F01)
F10	7.5 A - C3 signal l-module/satellite (60F01)	F24	15 A - Driver's window heating (32F07)	F39	3 A - Tyre pressure monitor
F11	15 A - Video monitor 1-4 (70F03)	F25	7.5 A - Throttle valve (17F09)	F40	7.5 A - Navigation computer (76F06)
F12	15 A - 24 V socket (02F07)	F26	7.5 A - Co-driver's roller sunblind (32F11)	F41	7.5 A - Driver's seat (81F02)
F13	7.5 A - Mirror adjuster (32F05)	F27	7.5 A - Telephone, radio (communications) (72F09)	F42	7.5 A - Download/diagnostics socket (05F02)
F14	15 A - Front box (50F02)	F28	25 A - Wiper (33F02)		
F15	7.5 A - Transmission (13F06)				



Note:

(2-axle buses only)

Practical advice

Fuse assignment for the main switch panel (under the driver's area), Tourismo RHD

Fuse assignment for the main switch panel (under the driver's area), Tourismo RHD

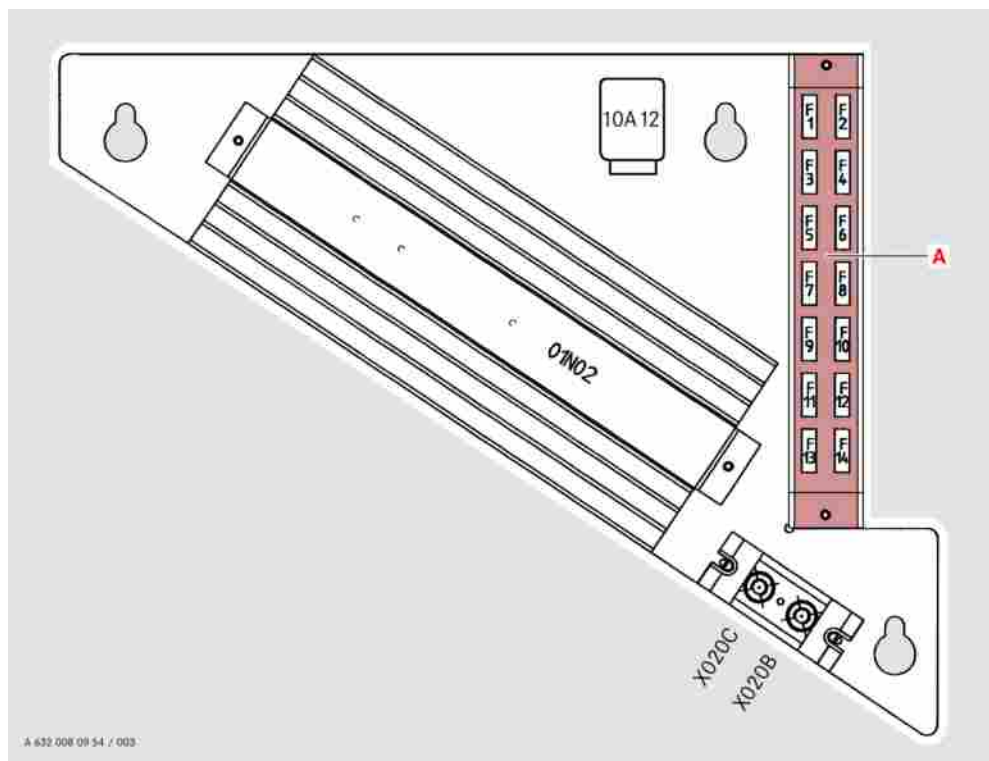

Fuse assignment for the main switch panel (under the driver's area), Turismo RHD

Fuse block A

F1	15 A - 12-volt sockets (02F08)
F2	7.5 A - Video monitoring system (70F06)
F3	7.5 A - Parking aid (70F07)
F4	7.5 A - Navigation computer (76F04)
F5	7.5 A - Radio (communications) (72F03)
F6	7.5 A - Telephone/radio (72F09)
F7	15 A - 12 V cigarette lighter (02F15)
F8	7.5 A - 12 V video system (70F10)
F9	Not assigned
F10	Not assigned
F11	1 A - Brake circuit pressure sensors (20F11)
F12	Not assigned
F13	7.5 A - Radio (communications) (72F02)
F14	7.5 A - 12 V Travel Pilot (76F02)

Fuse assignment for the auxiliary switch panel, Tourismo RHD

Fuse assignment for the auxiliary switch panel, Tourismo RHD

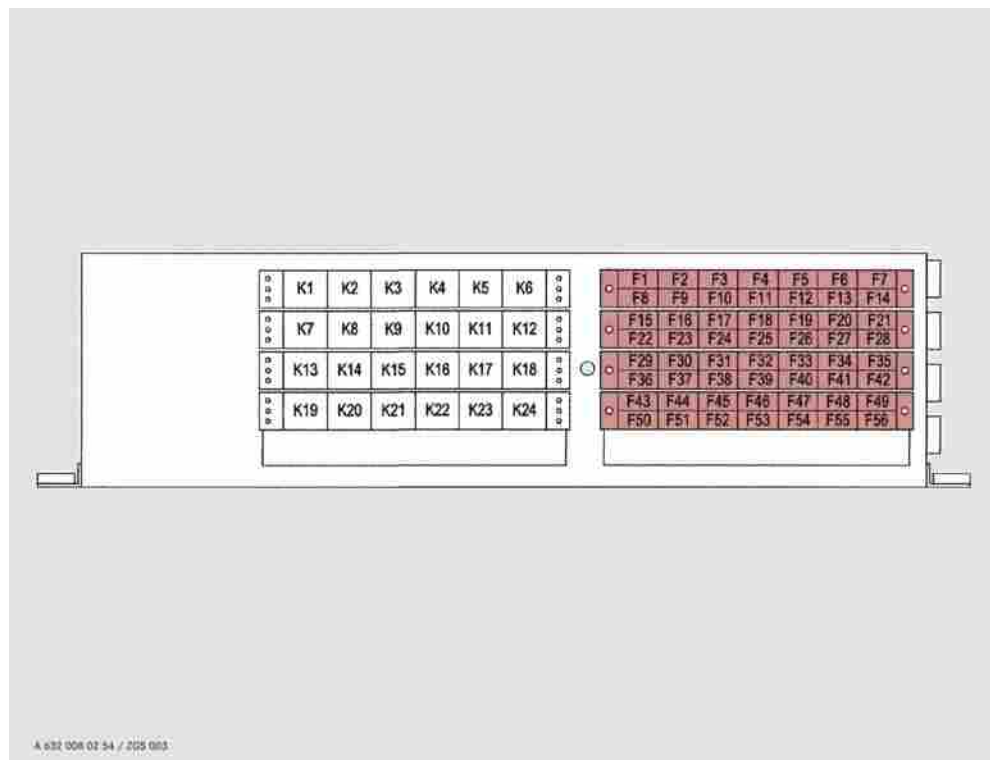

Fuse assignment for the auxiliary switch panel, Tourismo RHD

F1	7.5 A - Automated manual transmission (12F03)	F16	10 A - Automatic engine oil replenishment (15F02)	F29	15 A - Socket for auxiliary switch panel/engine compartment lighting (02F01)
F2	15 A - Coldbox (80F04)	F17	15 A - Heating for fuel filter (15F07)	F30	7.5 A - Engine compartment and lighting socket (02F04)
F3	7.5 A - Lavatory (80F24)	F18	10 A - SCR exhaust gas after-treatment supply line (17F01)	F31	20 A - SCR exhaust gas after-treatment supply line (17F02)
F4	15 A - Lavatory inverter (80F26)	F19	7.5 A - Trailer anti-lock braking system (ABS) (20F07)	F32	15 A - AdBlue line heating resistor (17F03)
F5	7.5 A - Driver's rest area (81F04)	F20	7.5 A - Compressed-air supply (24F01)	F33	25 A - Trailer anti-lock braking system (ABS) (20F08)
F6	7.5 A - Lavatory (80F05)	F21	7.5 A - Blower motor, entry 2 (53F10)	F34	7.5 A - Door 2 door-controller supply (42F05)
F7	15 A - Lavatory terminal 15 (80F11)	F22	7.5 A - D+ (01F04)	F35	15 A - Heater for heating-oil filter (54F05)
F8	15 A - Coldbox, kitchenette (80F08)	F23	5 A - Trailing axle NLA RAS-EC (22F06)	F36	7.5 A - Substation 1 (51F30)
F9	Not assigned			F37	7.5 A - Substation 0 (51F35)
F10	7.5 A - On-board kitchenette water pump (80F23)			F38	7.5 A - Sidewall heater 1 (53F01)
F11	7.5 A - Retarder RET terminal 15 (14F02)				
F12	7.5 A - Driver's day-bed in multi-purpose room (81F05)	F24	7.5 A - Smoke detection system (64F12)		
F13	Not assigned	F25	Not assigned		
F14	Not assigned	F26	Not assigned		
F15	7.5 A - Flexibly programmed controller (FPS) terminal 15 (04F17)	F27	7.5 A - Door 2 doorway lighting (42F02)	F39	7.5 A - Sidewall heater 2 (53F02)
		F28	7.5 A - Door 2 door-controller supply (42F04)		

 **Note:**
3-axle buses

 **Note:**
(on Travego)

Fuse assignment for the auxiliary switch panel, Tourismo RHD



Note:

(on Travego)

F40	7.5 A - Sidewall heater 3 (53F03)
F41	7.5 A - Sidewall heater 4 (53F04)
F42	15 A - Roof mixing circuit pump (53F16)
F43	155 A - Automated manual transmission GO 240-8 (12F04)
F43	7.5 A - Automated manual transmission AS Tronic (12F04)
F44	15 A - Automated manual transmission GO 240-8 (12F05)
44	7.5 A - Automated manual transmission AS Tronic (12F05)
F45	7.5 A - Fuel level sensor (65F08)



Note:

(3-axle buses only)

F46	15 A - Lavatory (winter-proof) (80F10)
F47	7.5 A - Starter control relay (10F38)
F48	1 A - Tank data recorder (65F04)



Note:

(on CC400)

F49	5 A - Trailing axle NLA RAS-EC (22F05)
-----	--



Note:

3-axle buses

F50	7.5 A - Retarder RET (14F3)
F51	Not assigned
F52	Not assigned
F53	Not assigned
F54	Not assigned
F55	Not assigned
F56	Not assigned

Fuse assignment for auxiliary switch panel with PDB

Fuse assignment for auxiliary switch panel with PDB

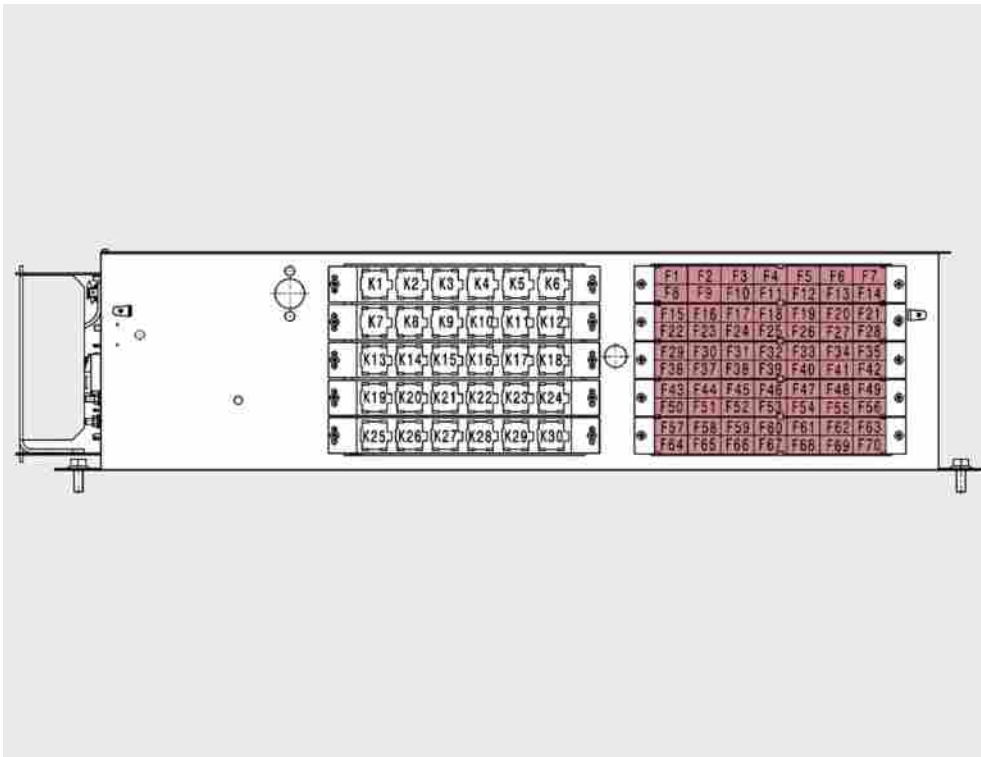

Fuse assignment for auxiliary switch panel with PDB

F1	Not assigned	F10	25 A - Fuel pump (15F15)	F25	7.5 A - Driver's day-bed / multi-purpose room (81F05)
F2	15 A - Automated manual transmission terminal 30 with new AMT (12F04)	F11	10 A - Automatic engine oil replenishment (15F02)	F26	Not assigned
F2	7.5 A - Automated manual transmission terminal 30 with AS Tronic (12F04)	F12	7.5 A - Lavatory terminal 15 (80F24)	F27	7.5 A - Doorway 2 lighting (42F02)
F3	15 A - Automated manual transmission terminal 30 with new AMT (12F05)	F13	7.5 A - Smoke detection system (64F12)	F28	7.5 A - Door 2 door control terminal 15 (42F04)
F3	7.5 A - Automated manual transmission terminal 30 with AS Tronic (13F04)	F14	7.5 A - Fire detection system/fire extinguishing system (64F13)	F29	7.5 A - Door 2 blower motor (53F10)
F3	15 A - Transmission terminal 30 (13F04)	F15	7.5 A - FPS terminal 15 (04F17)	F30	7.5 A - Engine compartment and lighting socket (02F04)
F4	15 A - Inverter in lavatory (80F26)	F16	3 A - Fuel pump switch (15F16)	F31	15 A - Coldbox, kitchenette (80F08)
F5	7.5 A - Driver's rest area (81F04)	F17	15 A - Heating for fuel filter (15F07)	F32	7.5 A - Alternator voltage sensing terminal 30 (01F20)
F6	7.5 A - Lavatory (80F05)	F18	Not assigned	F33	5 A - Trailing axle terminal 30 (22F05)
F7	15 A - Lavatory terminal 15 (80F11)	F19	Not assigned	F34	7.5 A - Door 2 door control terminal 30 (42F05)
F8	7.5 A - Retarder terminal 30 (14F03)	F20	7.5 A - Compressed-air supply (14F01)	F35	15 A - Heater for heating-oil filter (54F05)
F9	7.5 A - Driver's day-bed in multi-purpose room (81F05)	F21	7.5 A - Water pump for kitchenette (80F23)	F36	7.5 A - Trailer ABS terminal 15 (20F07)
		F22	Not assigned	F37	7.5 A - Substation 1 (51F30)
		F23	5 A - Trailing axle RAS-EC terminal 15 (22F06)	F38	7.5 A - Substation 0 (51F35)
		F24	15 A - Coldbox (80F04)	F39	7.5 A - Substation 2 (51F36)

Fuse assignment for auxiliary switch panel with PDB

F40	Not assigned	F57	7.5 A - FPS 1 (04F09)	F70	15 A - Master safety switch (03F01)
F41	25 A - Trailer ABS terminal 30 (20F08)	F58	7.5 A - FPS 2 (04F10)		
F42	15 A - Roof mixing circuit pump (53F16)	F59	7.5 A - FPS 3 (04F11)		
F43	Not assigned	F60	7.5 A - FPS 4 (04F12)		
F44	Not assigned	F61	7.5 A - FPS 5 (04F13)		
F45	Not assigned	F62	Not assigned		
F46	Not assigned	F63	7.5 A - Tachograph/instrument node (60F03)		
F47	3 A - LIN/CAN gateway 2 control unit terminal 15 (01F71)	F64	15 A - Lighting strip (31F05) tourist coach ceiling		
F48	3 A - LIN/CAN gateway 2 control unit terminal 30 (01F72)	F64	7.5 A - Lighting strip (31F05) public service bus ceiling		
F49	15 A - CAN gateway terminal 15 (10F64)	F65	15 A - Lighting strip (31F06) tourist coach ceiling		
F50	Not assigned	F65	7.5 A - Lighting strip (31F06) public service bus ceiling		
F51	Not assigned	F66	25 A - Auxiliary heating (54F01)		
F52	Not assigned	F67	25 A - Auxiliary heating (54F02)		
F53	Not assigned	F68	15 A - Central locking (82F01)		
F54	Not assigned	F69	7.5 A - Horn (for buses with Norwegian emergency switch-off) (33F01)		
F55	Not assigned				
F56	Not assigned				

Fuse assignment for the power distribution board (PDB), Turismo RHD

F1	15 A - Lighting strip (31F05)	F17	Not assigned	F32	50 A - Integrated electronics systems IES terminal 30 (01F05)
F2	15 A - Lighting strip (31F06)	F18	5 A - Starter battery (01F12)	F33	Not assigned
F3	15 A - Central locking (82F01)	F19	5 A - Modular switch panel MSF (61F02)	F34	50 A - Control units terminal 30 (08F05)
F4	Not assigned	F20	5 A - Central gateway CGW (05F03)	F35	Not assigned
F5	20 A - Auxiliary heating (54F01)	F21	5 A - Electronic ignition switch EIS terminal 30 (08F0)	F36	Not assigned
F6	20 A - Auxiliary heating (54F02)	F22	5 A - Tachograph (60F07)	F37	50 A - Flexibly programmed controller (FPS 4) (04F04)
F7	Not assigned	F23	15 A - Master safety switch (03F01)	F38	50 A - Flexibly programmed controller (FPS 5) (04F05)
F8	Not assigned	F24	7.5 A - Tachograph/instrument node (60F03)	F39	Not assigned
F9	7.5 A - Flexibly programmed controller (FPS 1) (04F09)	F25	50 A - Flexibly programmed controller (FPS 1) (04F01)	F40	Not assigned
F10	7.5 A - Flexibly programmed controller (FPS 2) (04F10)	F26	50 A - Flexibly programmed controller (FPS 2) (04F02)	F41	150 A - Inverter (01F47)
F11	7.5 A - Flexibly programmed controller (FPS 3) (04F11)	F27	50 A - Flexibly programmed controller (FPS 3) (04F03)	F42	80 A - Terminal 15 (01F17)
F12	5 A - Flexibly programmed controller (FPS 4) (04F12)	F28	Not assigned	F43	50 A - Main fuse terminal 15 (01F02)
F13	7.5 A - Flexibly programmed controller (FPS 5) (04F13)	F29	70 A - Kitchenette (80F01)	F44	150 A - Air-conditioning system (51F01)
F14	Not assigned	F30	50 A - Kitchenette (80F02)	F45	80 A - Mobility lift power supply (46F02)
F15	Not assigned	F31	70 A - Microwave/boiler (80F03)	F46	Not assigned
F16	7.5 A - Alternator voltage sensor (01F20)			F47	150 A - Grid heater control unit (10F41)

Fuse assignment for the power distribution board (PDB), Turismo RHD

F48	100 A - Main fuse terminal 30 (01F07)
F48	30 A - Engine management MCM main fuse (01F51)
F50	100 A - Main fuse terminal 30 (01F13)
F51	30 A - Exhaust gas aftertreat- ment control module ACM terminal 30 (17F11)

Fuse assignment for the ceiling switch panel, Turismo RHD

Fuse assignment for the ceiling switch panel, Turismo RHD

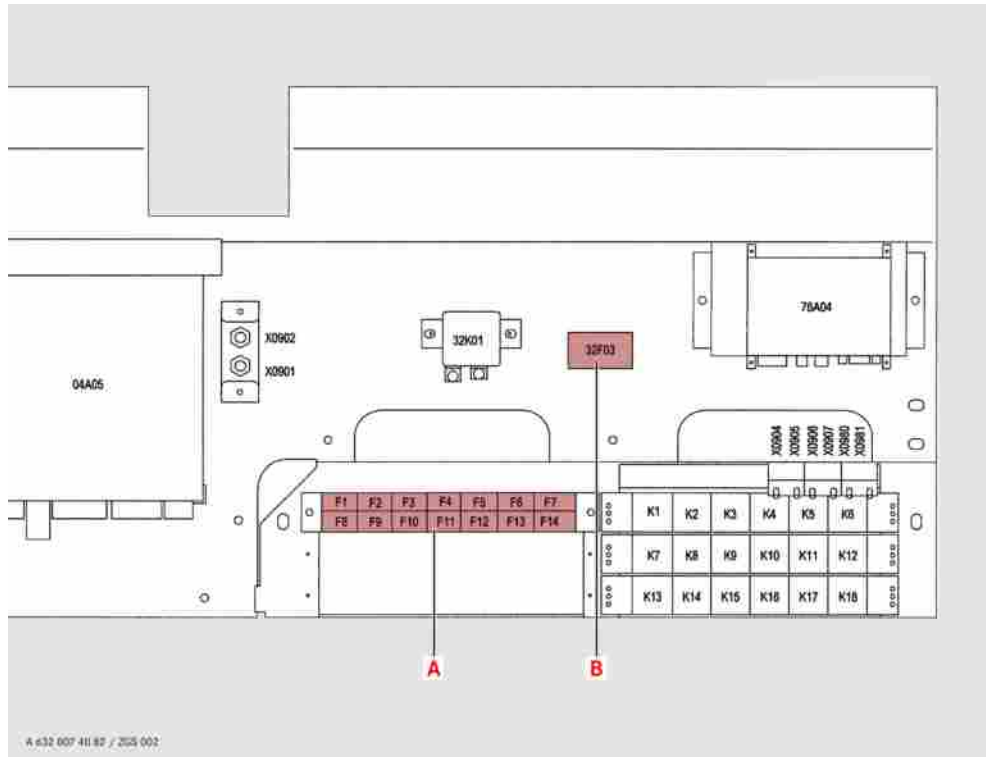

Fuse block A

- F1* 5 A - Rain sensor for roof hatch (52F04)
- F2* 7.5 A - Travel Pilot (76F01)
- F3* 30 A - Destination display, left (71F06)
- F4* 7.5 A - Clock, terminal 30 (65F01)
- F5* 7.5 A - Destination system (71F01)
- F6* 15 A - Reading lamps (31F04)
- F7* 7.5 A - Video system (70F40)
- F8* 7.5 A - Clock, terminal 15 (65F02)
- F9* 7.5 A - Video system (70F11)
- F10* 7.5 A - 12 V power supply (01F16)
- F11* 7.5 A - Video system (70F43)
- F12* 5 A - Roof hatch (52F01)
- F13* 5 A - Roller sunblind (32F16)
- F14* 15 A - Reading lamps (31F03)

Practical advice

Fuse assignment for roof-mounted heating, ventilation and air-conditioning system (Webasto)

Fuse assignment for roof-mounted heating, ventilation and air-conditioning system (Webasto)

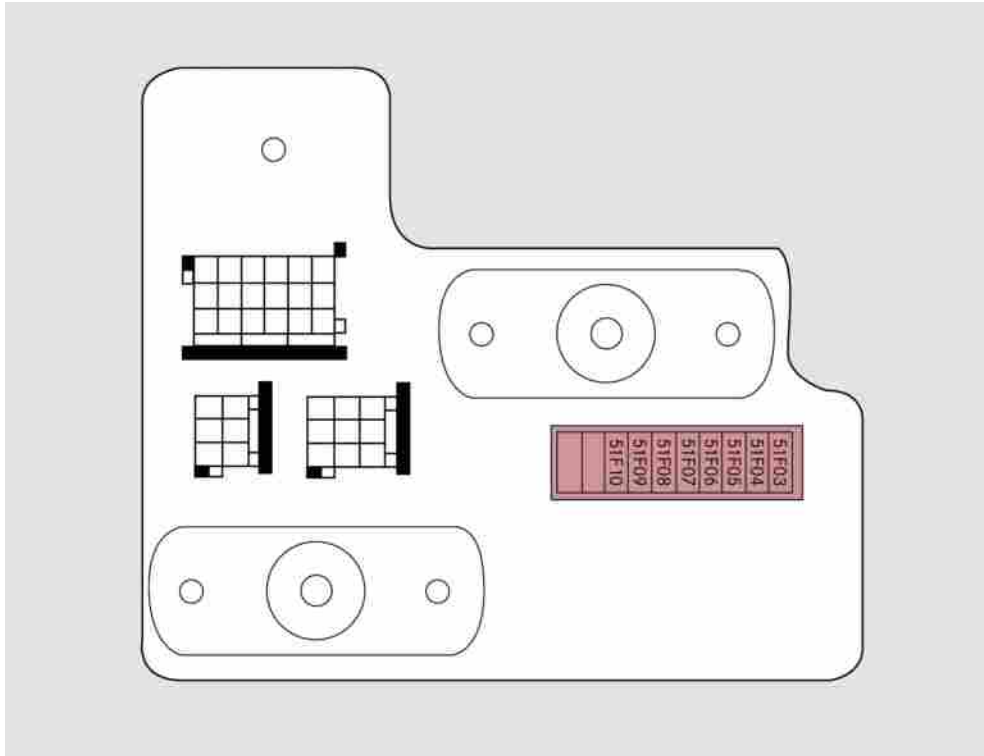

Fuse assignment for roof-mounted heating, ventilation and air-conditioning system (Webasto)

51F03	15 A - Fuse for evaporator blower, left
51F04	15 A - Fuse for evaporator blower, left
51F05	15 A - Fuse for evaporator blower, left
51F06	15 A - Fuse for evaporator blower, right
51F07	15 A - Fuse for evaporator blower, right
51F08	15 A - Fuse for evaporator blower, right
51F09	20 A - Fuse for condenser blower
51F10	20 A - Fuse for condenser blower

**Note:**

All fuses in the roof-mounted heating, ventilation and air-conditioning system are accessible from the vehicle interior.

**Note:**

Bus-specific fuse assignment and rating for the roof-mounted heating, ventilation and air-conditioning system are described on the label next to the fuses.

Practical advice

Fuse assignment for roof-mounted heating, ventilation and air-conditioning system (Konvekta)

Fuse assignment for roof-mounted heating, ventilation and air-conditioning system (Konvekta)

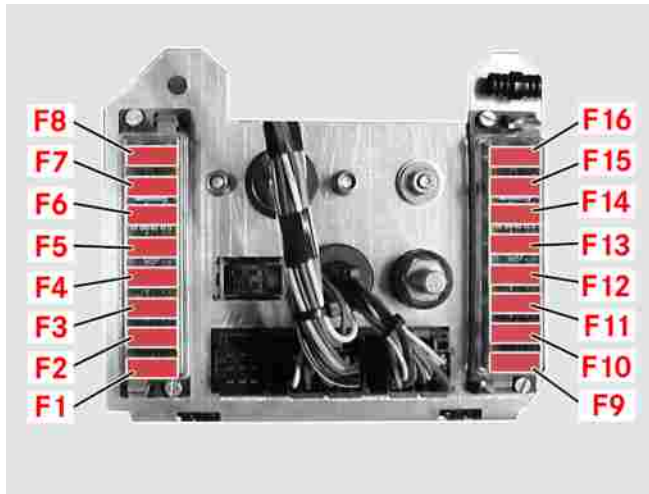

F1	15 A - Roof-mounted system blower speed-module fuse (51F03)	F10	25 A - Condenser blower speed module fuse (51F10)
F2	15 A - Roof-mounted system blower speed-module fuse (51F04)	F11	15 A - Condenser blower speed module fuse (51F11)
F3	15 A - Roof-mounted system blower speed-module fuse (51F05)	F12	Not assigned
F4	15 A - Roof-mounted system blower speed-module fuse (51F14)	F13	Not assigned
F5	15 A - Roof-mounted system blower speed-module fuse (51F06)	F14	Not assigned
F6	15 A - Roof-mounted system blower speed-module fuse (51F07)	F15	7.5 A - Refrigerant line shut-off valve fuse
F7	15 A - Roof-mounted system blower speed-module fuse (51F08)	F16	Not assigned
F8	15 A - Roof-mounted system blower speed-module fuse (51F15)		
F9	25 A - Condenser blower speed module fuse (51F09)		

Handling fuses

- ▶ Always carry some extra fuses in the bus for emergencies.



Caution:

Fuses provide protection against excessive current loads (impermissible heating of the wires) in the electrical system.



Note:

There are fuses located on the driver's area interior switch panel (01), on the switch panel under the driver's area (02), on the auxiliary switch panel (03) and on the ceiling switch panel (09), as well as in the roof-mounted heating, ventilation and air-conditioning system in the ceiling duct above the WC and on fuse switch panel (PDB) (06).



Note:

All fuses in the roof-mounted heating, ventilation and air-conditioning system are accessible from the vehicle interior.



Note:

Bus-specific fuse assignment and rating for the roof-mounted heating, ventilation and air-conditioning system are described on the label next to the fuses.

Disconnecting vehicle batteries

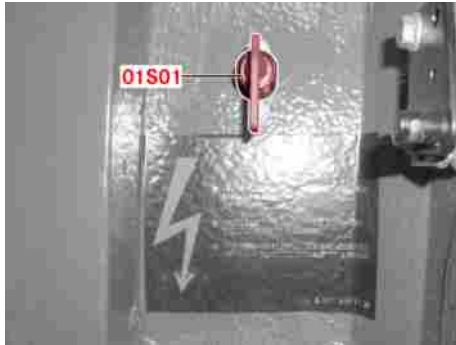

M54_00-1058-71

- ▶ These notes must be observed without fail.

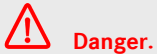

Danger.

Make sure that you correct the cause of the short circuit before you change a blown fuse. Check that the connections have a good contact.



Danger.

Never bridge or repair fuses.



Danger.

Only use fuses of the specified amperage. Never replace fuses with those of a higher ampere rating as this could lead to damage to the electrical system.



Danger.

Always switch off the battery isolating switch (01S01) before work is carried out on the electrical system.

Disconnecting vehicle batteries

- ▶ Switch off the engine.

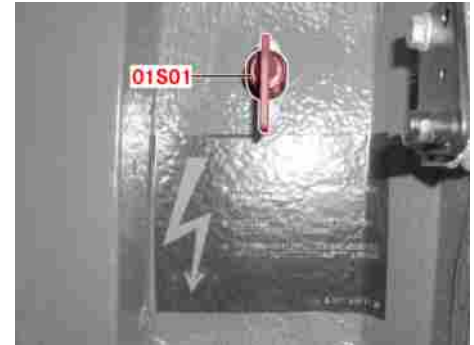

M54_00-1058-71

- ▶ Switch off the battery isolating switch (01S01).



Danger.

There is a risk of explosion from the ignition of oxyhydrogen gas by separation sparks while the batteries are being disconnected. To rule out this risk of injury, there is a battery isolating switch (01S01) that bears an appropriate warning label to this effect.

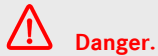

Danger.

Switch the battery isolating switch to the OFF position (key can be removed) before working on parts of the vehicle electrical system, especially the batteries. The battery isolating switch interrupts the main line from the positive terminal of the battery to the entire vehicle electrical system; for this reason, it must not be switched off until the ignition switch has been switched off and the water heater's run-on period has ended (risk of overheating).



Danger.

Only lead-acid batteries are permitted to be fitted, never gel batteries. All cells of the batteries must be fitted with special caps that are interlinked by vent hoses, thereby allowing any gases produced to be directed into the open air.

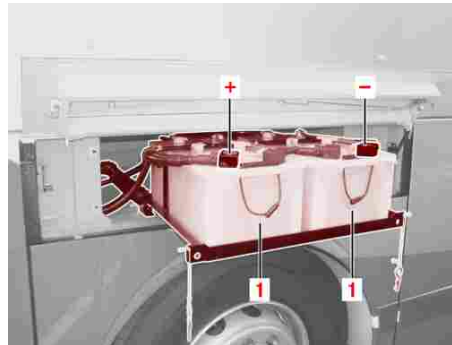

M54_00-0904-01

- ▶ Remove the negative terminal clamp from the battery.
- ▶ Remove the positive terminal clamp from the battery.
- ▶ Reconnect the batteries in reverse order.

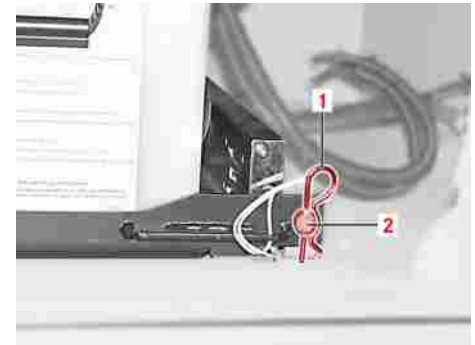

M54_00-0839-01

- ▶ Push the battery carriage back in as far as the stop until pins (2) with a hole in the side are revealed, and then secure using two split pins (1) on the left- and right-hand side.



Danger.

Securing split pins (1) for the battery carriage must always be fitted on both the left- and right-hand side to prevent the batteries from working their way out while the bus is in motion.

Recharging vehicle batteries

Recharging vehicle batteries



Note:

Recharge out-of-service batteries once a month.

- ▶ Connect the charger.



Danger.

Risk of explosion from oxyhydrogen gas formation. Make sure that the area is well ventilated when you are recharging the vehicle batteries.



Note:

Check that the charging voltage (24 or 12 V) and charging current (approximately 1/10 of the rated capacity, e.g. 200 Ah battery with 20 A charging current) are correct.

- ▶ Switch off the charger after charging has finished.



Danger.

Do not disconnect the connection terminals until the gases have stopped escaping from the battery (wait a few minutes).

Notes on jump-starting

- ▶ Follow the instructions for the jump-start procedure.



Caution:

Before you connect the jump leads, check that the operating voltage (24 V) and polarity are the same.



Caution:

Only jump leads (cable cross-section approximately 70 mm²) are permitted to be used as a starting aid – never use a rapid charger. Comply with the safety regulations.



Caution:

Use only jump leads that have insulated terminal clips.



Note:

A discharged battery can freeze at temperatures below -10 °C. It must be thawed before the jump-start operation.



Danger.

Risk of acid burns. Do not lean over the battery during the jump-start procedure.

Jump-start procedure

- ▶ Turn the key back to the stop in the ignition switch.
- ▶ Connect one end of the positive cable to the (+) terminal of the discharged battery first, then connect the other end of the positive cable to the (+) terminal of the donor battery.
- ▶ Connect the negative cable to the (-) terminal of the donor battery, and then connect the other end of the negative cable to an earthed metal part that is bolted onto the bus skeleton.



Note:

As far as possible from the discharged battery.

- ▶ Run the engine of the donor vehicle at an elevated speed.

- ▶ Start the engine of the bus to be jump-started in the normal way and let it run at idling speed.
- ▶ Switch off the engine of the donor vehicle.
- ▶ Fully disconnect the earth connection of the jump leads then disconnect the positive cable.



Note:

To prevent voltage peaks, switch on the more powerful consumers of the jump-started bus, such as the lighting, heated windows or ventilation, before you disconnect the jump leads.

Activation of on-board diagnostics

Activation of on-board diagnostics



Note:

On-board diagnostics cannot be regarded as a substitute for off-board diagnostics (STAR Diagnosis) because off-board diagnostics is the only means by which some functions can be monitored and tested (e.g. the channel assignment for the sensor system and actuators of the EBS or ABS/ASR system).

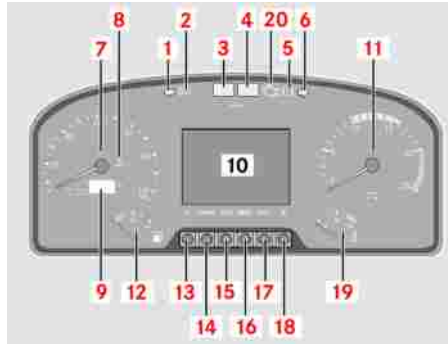

M68_00-0214-71

- ▶ Press System button (14) repeatedly until the relevant system is shown on display screen (10).



Note:

The on-board diagnostics cannot be activated unless: - the bus is stationary - the parking brake is applied - the ignition switch is in the ON position



Danger.

All work carried out on the bus in order to rectify displayed faults must be performed by authorised personnel only.

- BS Brake control
- GS Automated manual transmission (ASG)
- FR Drive control or CPC (common powertrain controller)
- PLD Engine control (PLN MR)
- RS Retarder control
- TCO Tachograph
- FPS Flexibly programmed controller
- DM Driver's station display multiplexer
- HLK Heating, ventilation, air-conditioning (ATC-CAN)
- ZV Central locking (option)

Interpreting the on-board diagnostics screen display

- ▶ Press Info button (17).

i Note:

The following information can be displayed: MBS Mercedes-Benz part number (control unit) F Fault code (current/stored fault) MW Measured values (actual values) BW Binary values.

Interpreting the on-board diagnostics screen display

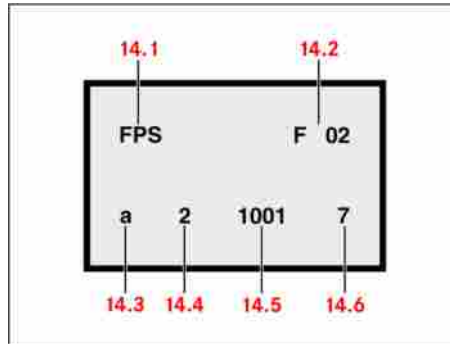

M54_00-0193-01

- ▶ Example:

i Note:

FPS system (14.1)

i Note:

Fault 2 (14.2)

i Note:

Current faults (14.3)

i Note:

Fault severity 2 = serious (14.4)

i Note:

Fault code 1001 (14.5)

i Note:

Channel 7 (14.6)

Clearing the fault memory of the selected system

Clearing the fault memory of the selected system

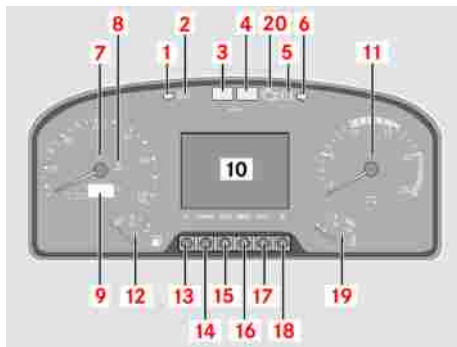

M68_00-0214-71

- ▶ Press and hold “Reset” button (16). Also press “Quit” button (15) until “Reset” is shown on display screen (10).

Ending on-board diagnostics

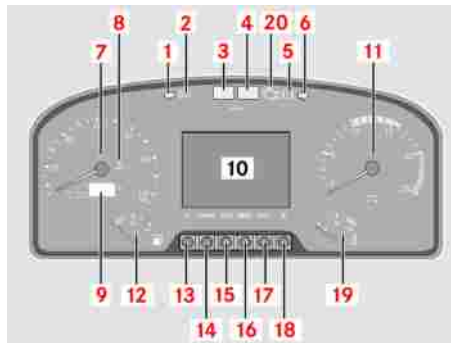

M68_00-0214-71

- ▶ Press “Quit” button (15).

Changing bulbs



Note:

Bulbs and lamps are an integral part of bus safety. Make sure that all bulbs are always in working order.



Danger.

Bulbs can become extremely hot. There is a risk of burns. Before changing bulbs, allow them to cool off completely.



Danger.

Always wear safety goggles and non-slip gloves to prevent injury when changing bulbs.



Caution:

To prevent a short circuit, always switch off the lighting before you change a bulb.

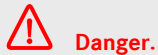

Danger.

Do not use a bulb that has been dropped or has scratches on the glass. The bulb is pressurised and may explode. You could be injured by glass splinters from broken bulbs.



Caution:

Protect bulbs from moisture during operation and do not allow them to come into contact with fluids.



Caution:

Marks on the glass diminish the service life of the bulb. Do not touch the glass bulb with your bare hands. If you do, clean the glass bulb while cold using alcohol or spirit and rub dry with a lint-free cloth.



Note:

Bulbs must be operated only in the closed lamp units for which they are intended. Always use replacement bulbs of the same type and the correct voltage rating.



Note:

Check the contacts for corrosion; clean if necessary.



Caution:

Check the seals for correct seating; replace damaged seals with new ones.



Danger.

Keep children away from bulbs.



Environmental protection

Comply with legal requirements when you dispose of bulbs or fluorescent tubes.



Danger.

Gas discharge bulbs operate at high voltage, high pressure and high temperature. There is a risk of fatal injury if live parts of the lamp and ballast unit are touched. Do not touch the gas discharge bulb if the headlamp is damaged.



Danger.

Do not change gas discharge bulbs yourself. Always have defective gas discharge bulbs changed at a qualified specialist workshop which has the necessary specialist knowledge and tools for the work required. EvoBus recommends an OMNIplus Service Partner for this purpose.

Changing bulbs



Danger.

It is essential that work relevant to safety or work on safety-related systems be carried out at a qualified specialist workshop.

Changing bulbs in the headlamps/front foglamps/front turn signal

- ▶ Remove cover (4 quick-release locks on right).



Note:

The headlamp is accessible from the vehicle interior (right) or via the service cover under the driver's area (left). This cover can be opened using the handle on the left next to the driver's seat.

- ▶ When changing the turn signals, turn the bulb socket anti-clockwise and take it out. Press the bulb in, turn it anti-clockwise and remove.
- ▶ To replace the bulb, push the wire loop for the main headlight/front foglamp to the side and remove the plastic cover.
 - ▶ Disconnect bulb cable (5).
 - ▶ Detach retaining spring (6) and take out the bulb.



Note:

Refit in reverse order.

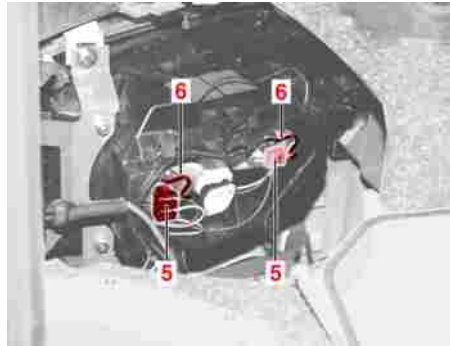

M54_00-0102-01



Note:

Insert the new bulb so that the guides on the socket plate engage in the recesses on the headlamp mirror neck.



Note:

Refit in reverse order.

Changing the bulb in the clearance lamp

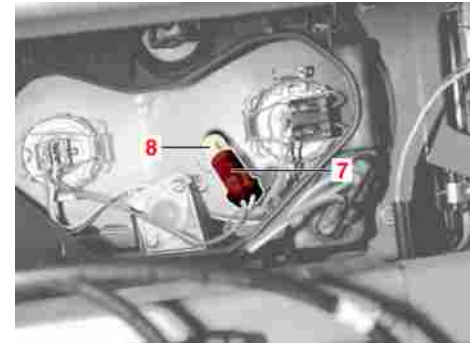

M54_00-0103-01

- ▶ Pull out bulb socket (7) to the rear.

- ▶ Pull glass-base bulb (8) out of the socket.



Note:

Refit in reverse order.

Changing the bulb in the side-mounted turn signal

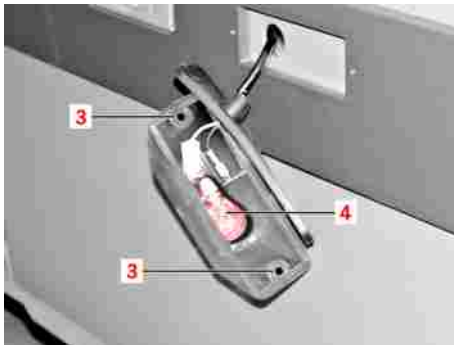

M54_00-0105-01

- ▶ Unscrew securing screws (3) and remove the housing.
- ▶ Press bulb (4) in, turn it anti-clockwise and remove.



Note:

Refit in reverse order.

Changing a bulb in the rear lamp cluster

- ▶ Open the left or right service cover.
- ▶ Turn the base of the relevant bulb 45° anti-clockwise.
- ▶ Press the bulb in, turn it anti-clockwise and remove.



Note:

Refit in reverse order.

Changing a bulb in the upper rear lamp cluster

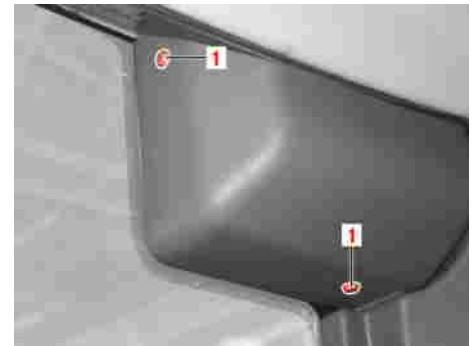

M54_00-0882-01

- ▶ Remove cover caps (1), unscrew the screws and open the plastic cover on the left or right.

Changing bulbs



M54_00-0678-01

- ▶ Turn base (2) of relevant lamp (3) or (4) 45° anti-clockwise.
- ▶ Press the bulb in, turn it anti-clockwise and remove.



Note:

Refit in reverse order.

Changing the bulb in the doorway lamp



M54_00-0110-01

- ▶ Unscrew and remove two securing screws (1) and remove the lamp.
- ▶ Take out the bulb.



Note:

Refit in reverse order.

Changing the fluorescent tube of the lavatory lighting

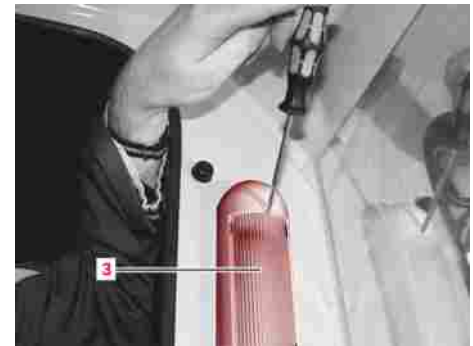

M54_00-0114-01

- ▶ Remove cover (3) using a screwdriver.
- ▶ Turn the fluorescent tube through 90° and remove it.



Note:

Refit in reverse order.

Adjusting the headlamps for driving on the left or right (only in buses with bi-xenon headlamps)

Adjusting the headlamps for driving on the left or right (only in buses with bi-xenon headlamps)



Caution:

In vehicles with bi-xenon headlamps, it is possible to adjust the headlamps for right-hand-drive or left-hand-drive operation. Please observe the rules and regulations of the country in which the vehicle is operated.

- ▶ Switch off the lighting.



Danger.

Bulbs and bulb holders may be hot and bulbs are pressurised.

- ▶ Remove the cover.



Note:

The headlamp is accessible from the vehicle interior (right) or via the service cover under the driver's area (left).

- ▶ Switch off the lighting.



Danger.

Remove the ignition key. The lighting system must be de-energised. Caution: gas discharge lamps operate at high voltages.

- ▶ Open the plastic cover by turning anti-clockwise and remove.

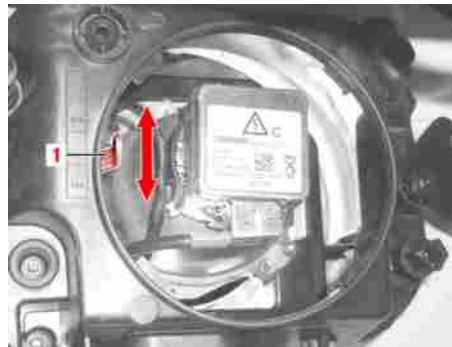

M82.00-0142-71

- ▶ The headlamp is adjusted with metal bar (1).



Note:

Push metal bar (1) upwards: driving on the right.



Note:

Push metal bar (1) downwards: driving on the left.



Note:

Refit in reverse order.

Emergency operation of the doors (depressurising the doors using the emergency valves)

Emergency operation of the doors (depressurising the doors using the emergency valves)

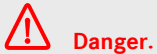

Danger.

All doors must remain unlocked while the bus is in motion. - refer to Operating Instructions sections: “Opening/Locking”, “Unlocking the door circuit at the front right door / Unlocking the centre right door / Unlocking the door circuit using the radio remote control (option)”

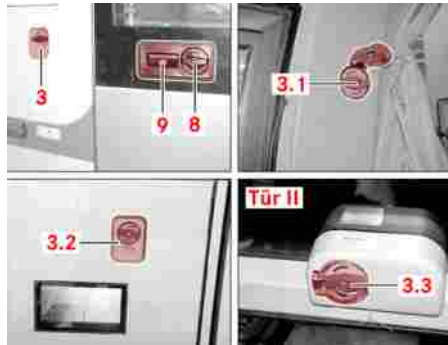

M72_00-0023-01

- ▶ Remove the security seal from the emergency valve.



Note:

3 Exterior emergency valve, front right door



Note:

3.1 Interior emergency valve, front right door



Note:

3.2 Exterior emergency valve, centre right door



Note:

3.3 Interior emergency valve, centre right door

- ▶ Turn interior emergency valve (3.1/3.3) or exterior emergency valve (3/3.2) in the direction of the arrow.



Note:

When the emergency valve is operated, the door valve is vented of air. At the same time, the emergency valve also releases the air in the door system. The door system is now depressurised and it must now be possible to move the door manually.

Emergency unlocking of the luggage compartment flaps in the event of a compressed-air supply failure



The warning buzzer sounds in the driver's area. The red warning lamp in the relevant door pushbutton must flash. This symbol appears on the instrument cluster display screen together with a red alert.

- ▶ Restoring operation of the door system: - move the emergency valve into the normal position - the door compressed-air system is slowly refilled through a door actuation throttle valve and returns to the condition it was in before the emergency valve was operated.



Danger.

Risk of injury. Make sure that nobody is within the sweep of the door leaf when operation of the door system is restored. Doors must not move with a jerky or jolting action after normal operation has been restored.

- ▶ Provide the emergency valve with a new security seal.

Emergency unlocking of the luggage compartment flaps in the event of a compressed-air supply failure



Note:

If there has been a complete failure of the central compressed-air supply and the electrical power supply, the luggage compartment flaps can be emergency-unlocked by means of an emergency operating facility (spare wheel compressed-air reserve).

Emergency unlocking of the luggage compartment flaps in the event of a compressed-air supply failure



M00_00-0084-01

- ▶ Open the front cover of the bus using lever (1) at the front right door entrance
- ▶ Remove the spare wheel

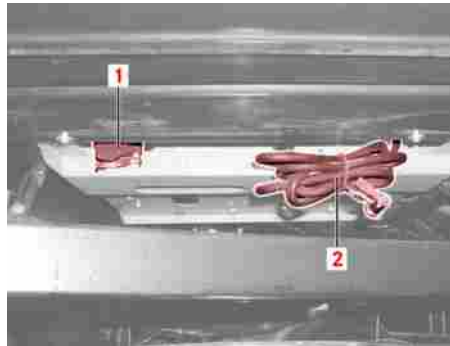

M40_00-0073-01

- ▶ Take the hose with tyre connection (2) from the plate behind the heating front cabinet and connect it to the tyre inflation valve on the spare wheel.



Note:

Reinflate the spare wheel to the specified pressure as soon as possible.



Note:

The spare wheel has a pressure of approximately 8 bar. The compressed air in the spare wheel passes through shuttle valves to the cylinders of the luggage compartment locking system and unlocks the luggage compartment flaps. The luggage compartment flaps can then be opened.

Removing the exterior mirror, fitting the emergency mirror (option)

Removing the exterior mirror, fitting the emergency mirror (option)

i Note:

The emergency mirror (option) is located in the luggage compartment and can be fitted to both sides. Tools needed for assembly: WAF 6 Allen key, screwdriver, WAF 15 open-ended spanner

! Danger.

Always make sure that the ladder you use is suitable for the task. Secure the ladder against sliding away.

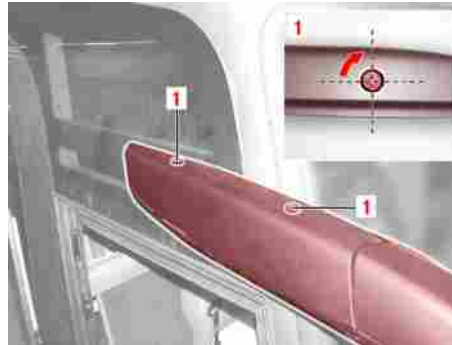

M88_70-0002-01

- ▶ Remove the upper cover cap from the mirror arm. To do this, push in the two quick-release locks (1) and rotate through 90° (position transverse to the direction of travel).

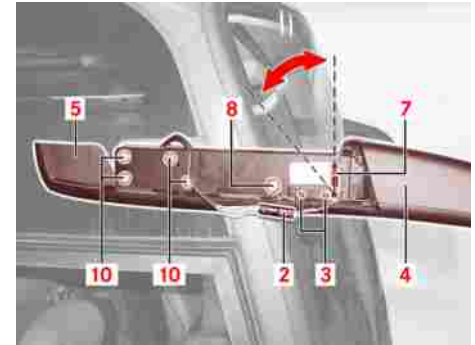

M88_70-0004-01

- ▶ Disconnect electrical plug connection (2) from the plug. Pull retaining clip (7) outwards, twist through 30°. Loosen clamp bolts (3) a few turns. If lock (8) is installed (option) it must be unlocked. Pull mirror head (4) forwards out of mirror arm (5).
- ▶ Unscrew securing screws (10) from mirror arm (5). Remove mirror arm (5).

Emergency operation for heating in driver's area

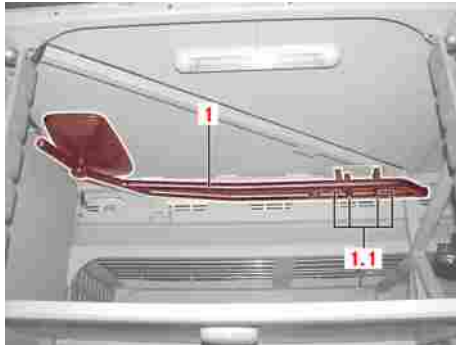

M88_70-0003-01

- ▶ Unscrew securing screws (1.1) for emergency mirror (1) and remove the emergency mirror.
- ▶ Fit the emergency mirror to the attachment points on the mirror arm and tighten securing screws (10).

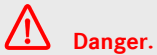

Danger.

Check the emergency mirror is securely attached, adjust the emergency mirror.



Danger.

The exterior mirrors reduce the size of images. Objects may actually be closer than they seem.

Emergency operation for heating in driver's area



M83_00-0176-01

- ▶ Remove front service cover (1). To do this, unscrew securing screws (2).

Emergency operation of the passenger-compartment heating

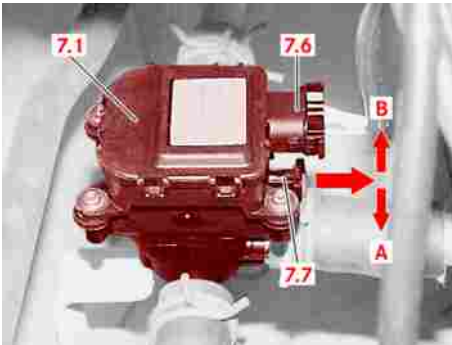

M83_00-0098-01

- ▶ Disconnect electrical connector (7.6) with water control valve (7.1) disconnected from the power
- ▶ Pull emergency lever (7.7) in the direction of the arrow
- ▶ Move emergency lever (7.7) towards “A” = close valve, towards “B” = open valve

i Note:

An end stop can be felt which indicates that the respective limit position has been reached. During emergency operation, it is not possible to regulate the outlet temperature of the heating in the driver's area electronically.

Emergency operation of the passenger-compartment heating



M83.00-0939-71

- ▶ Operate supply line manual shut-off valve (1)

i Note:

In the event of uncontrollable heating, ventilation and air-conditioning (leaky heating control valve/heating in summer) and if the heating system is no longer leak-tight, it is possible to isolate the heating system coolant circuit from the engine coolant circuit using the two manual shut-off valves in heater supply line (1) and in the heater return line.

Maintenance tasks for the air-conditioning system in the bus (filter maintenance)



Caution:

Do not switch on the heating or water heater.

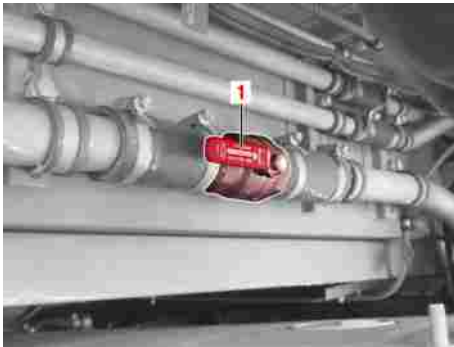

M83.00-0940-71

- ▶ Operate return line manual shut-off valve (1)



Note:

Manual shut-off valve (1) is located above the engine in the engine compartment.

Maintenance tasks for the air-conditioning system in the bus (filter maintenance)

Cleaning/replacing the recirculated-air filters

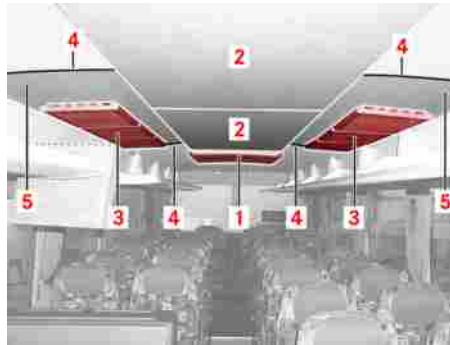

M83_00-0505-71

- ▶ Switch the ignition starter switch to OFF.
- ▶ Cover seats and floor linings for protection.
- ▶ Remove left- and right-side recirculated-air filter cassettes (3).



Note:

Recirculated-air filter cassettes (3) are each secured by 4 plastic screws (quick-release locks). To open, press the screws upwards slightly and turn them through 90° anti-clockwise.

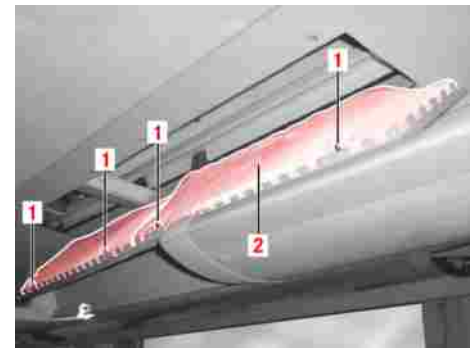

M83_00-0423-01

- ▶ Clean or exchange filter material (2) and refit the recirculated-air filter cassettes.

Maintenance tasks for the air-conditioning system in the bus (filter maintenance)



Note:

To close, press plastic screws (1) (quick-release locks) upwards slightly and turn them through 90° clockwise.



Note:

Installation position: colouring (labelling) facing up.

Cleaning or replacing the fresh-air/ recirculated-air filters

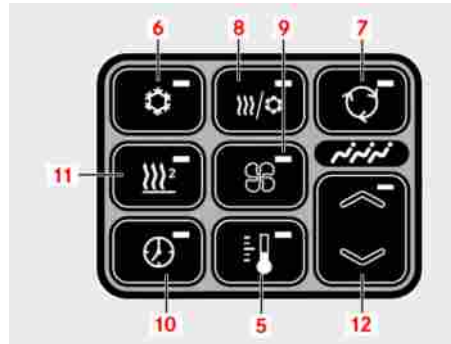

M83.00-0901-71

- ▶ Switch the ignition starter switch to ON
- ▶ Press button (7) on the HVAC control panel and wait 10 seconds.
- ▶ Switch the ignition starter switch to OFF.
- ▶ Fold down the recirculated-air filter cassettes on the left- and right-hand side.



M83_00-0422-01

- ▶ Remove all fresh-air/recirculated-air filters (1) on the left- and right-hand side.
- ▶ Clean or replace the filters with new ones.
- ▶ Assembly in reverse order

Cleaning the fresh-air filter in the driver's area

- ▶ Open the spare wheel flap at the front of the bus (lever in entrance of front right door)

Scopes of maintenance for the air-conditioning system

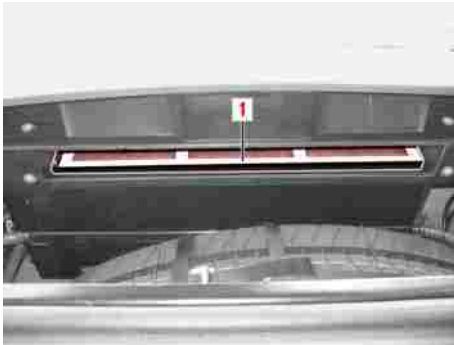

M83_00-0796-71

- ▶ Lift the fresh-air filter mat up with both hands (approximately 6 mm) and then pull it out downwards and towards you.
- ▶ Clean the fresh-air filter mat by beating out the dust, vacuuming or blasting with compressed air against the intake direction and then refit it. Exchange the filter mat if necessary.

Scopes of maintenance for the air-conditioning system

Cleaning the condenser



Note:

Check and clean condenser (4) only with the engine and air-conditioning system switched off

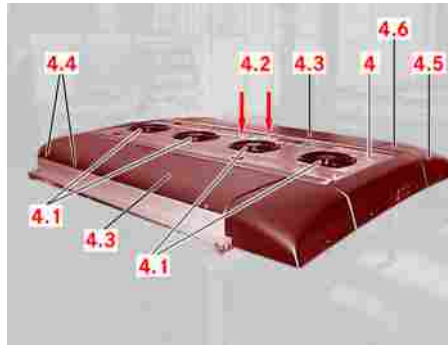

M83_00-0105-01

- ▶ Fully unscrew condenser fans (4.1)



Danger.

The condenser is accessible for cleaning only from the roof. Secure the bus in stationary position so that it cannot be set in motion by an unauthorised person. Implement the necessary safeguards to prevent a fall from the roof (safety harness, scaffold, ladder, etc.).

- ▶ For normal levels of dirt, blow out the dust that has deposited in the fins with compressed air in the direction of arrow (4.2)
- ▶ For stubborn dirt, spray into the fins with a grease-dissolving substance (cold cleaner), allow it to work and then spray it off with water. Blow it dry with compressed air in the direction of arrow (4.2)

Scopes of maintenance for the air-conditioning system



Note:

To prevent deformation of the fins, the jet of air or water must always be directed perpendicular (90°) to the condenser surface.

- ▶ Then check condenser fans (4.1) for correct operation: air drawn in the opposite direction to the arrow (4.2)



Note:

A dirty condenser causes an increase in pressure in the refrigerant system and a safety switch response (high pressure). The cleaning interval depends on the length of operation and the load to which the system is subjected.

Carrying out the compressor maintenance program

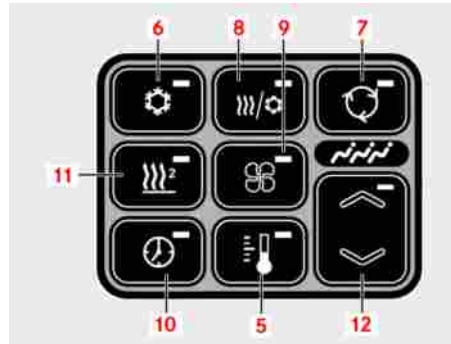

M83.00-0901-71

- ▶ Press and hold A/C enable button (6) and rocker switch (12) on the control panel simultaneously with the ignition starter switch OFF. Switch the ignition starter switch to ON and start the engine. The LED in Smog button (7) starts to flash and the LED in button (6) lights up. The air-conditioning system is switched on after a delay of approximately 60 seconds, and the “Air-conditioning compressor in operation” symbol appears on the screen.

The maintenance program is ended automatically after approximately 5 minutes and the LED in Smog button (7) stops flashing. The only way to interrupt the program prematurely is to switch off the engine (ignition starter switch OFF).



Note:

To ensure that the slide ring seal on the compressor crankshaft does not dry out and start to leak, the air-conditioning system must be operated at least once a month (even in the cold season).



Note:

The maintenance program for the compressor cannot be carried out unless the outside temperature is above 0 °C and the coolant temperature (engine circuit) is above 50 °C.

Scopes of maintenance for the air-conditioning system

Checking the oil level in the refrigerant compressor

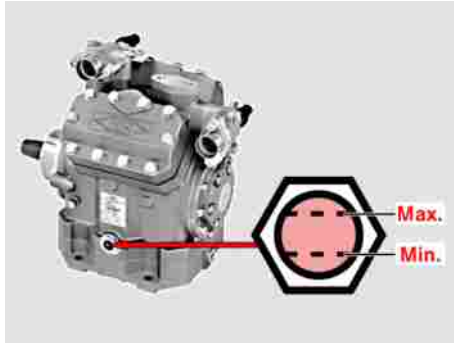

M83_00-0425-01

- ▶ Check the inspection glass on the refrigerant compressor when the compressor is running (after approximately 10 - 15 minutes). The oil level should be between the marks (min. and max.).

i Note:

Refrigerator oil is circulated together with the refrigerant in the entire refrigerant system. For this reason, the oil level may differ with each check but must still be between the min. and max. marks on the inspection glass. Have underfilled refrigerant oil topped up only by the authorised specialists of an OMNIplus Service Partner.

i Note:

To ensure that the slide ring seal on the compressor crankshaft does not dry out and start to leak, the air-conditioning system must be operated once a month for approximately 10 - 15 minutes by pressing Reheat button (8) on the HVAC control panel. At outside temperatures of below +5 °C, the procedure should be carried out indoors otherwise the system will be switched off by the low-pressure switch or ice sensor.

Checking the coolant level

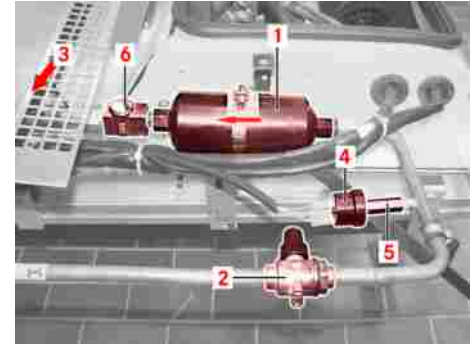

M83_00-0409-01

- ▶ Open the rear right-hand service cover on the roof

! Danger.

Secure the bus in stationary position so that it cannot be set in motion by an unauthorised person. Implement the necessary safeguards to prevent a fall from the roof (safety harness, scaffold, ladder, etc.).

- ▶ Heat up the vehicle interior to > 26 °C

Cleaning the heating system water filter

- ▶ Switch on the air-conditioning system



Note:

Engine speed approximately 1,500 rpm.

- ▶ Check the refrigerant level in inspection glass (6) after an operating time of 15 - 20 minutes:



Note:

The refrigerant must be flowing in inspection glass (8) without any bubbles.



Note:

Have the underfilled refrigerant topped up only by the authorised specialists of an OMNIplus Service Partner.

Cleaning the heating system water filter

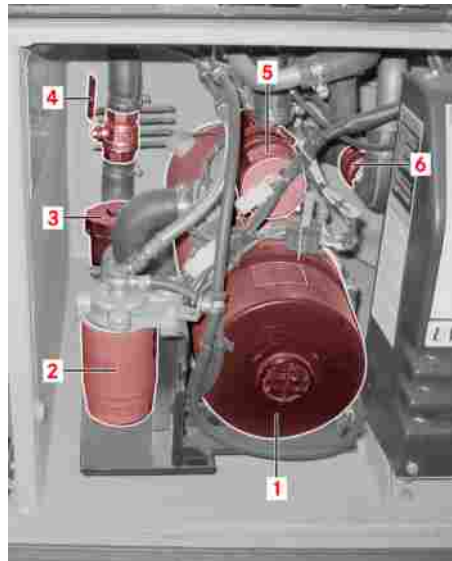

M83_00-0719-72

- ▶ Switch off water heater (1) using the battery isolating switch before removing water filter (3)



Danger.

Risk of scalding to skin and eyes from hot coolant spraying out. Wear protective clothing (gloves/safety goggles). Risk of poisoning if coolant is swallowed.

- ▶ Close shut-off valve (4) upstream of the water filter and shut-off valve (6) in the heater supply line

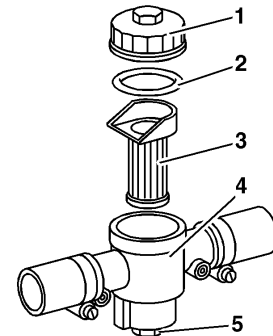

M20_00-0002-01

- ▶ To isolate the water supply at the water filter or drain the filter housing (approximately 1.5 litres), close shut-off valve (5) on the coolant filter (WAF 32).

Cleaning the heating system water filter

- ▶ Unscrew cover (1) from the coolant filter (WAF 32) and remove filter insert (3) from filter housing (4).
- ▶ Clean filter insert (3) in running water.



Note:

If the filter insert is heavily contaminated, it can be cleaned with compressed air (maximum 5 bar).

- ▶ Check the cleaned filter insert for damage.



Environmental protection

Damaged filter inserts must always be replaced with new ones.

- ▶ Insert filter insert (3) into filter housing (4) and screw on cover (1) with a new O-ring (2).

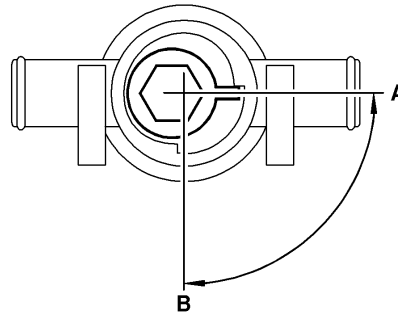

M20_00-0003-01

- ▶ Reopen shut-off valve (5) on the coolant filter (WAF 32).



Note:

Position: A = open; B = closed

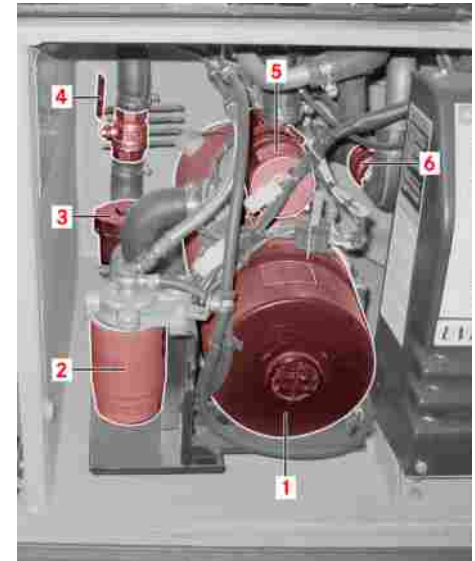

M83_00-0719-72

- ▶ Reopen shut-off valve (4) upstream of the water filter and shut-off valve (6) in the heater supply line.

Bleeding the coolant circuit for the heating system

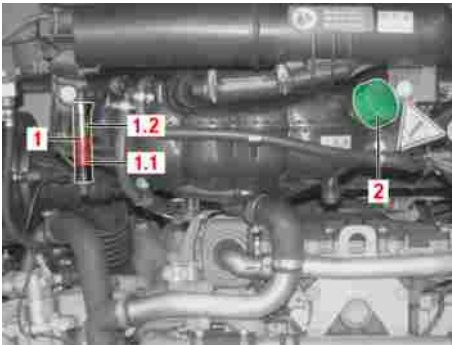

M54.00-2108-71

- ▶ Check the coolant level in the expansion tank and top it up if necessary.

Bleeding the coolant circuit for the heating system

 **Danger.**

There is a risk of scalding to skin and eyes from hot coolant spraying out. Wear protective clothing (gloves/safety goggles). Do not open the sealing cap on the coolant expansion tank unless the coolant temperature is below 50 °C. Risk of poisoning if coolant is swallowed.

 **Note:**

The heating, ventilation and air-conditioning control panel features an integrated “filling program”. This program provides all the necessary functions (control of recirculation pumps and coolant valves) for filling and bleeding the heating system coolant circuit completely.

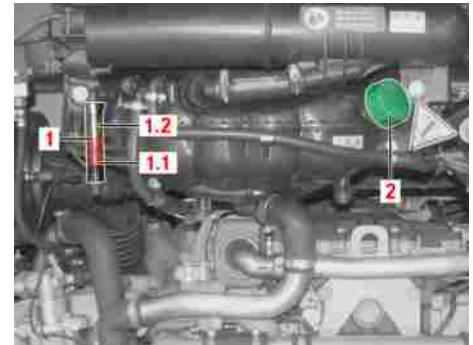

M54.00-2108-71

- ▶ Open sealing cap (2) slowly to relieve the excess pressure. Then unscrew and remove the sealing cap.

Bleeding the coolant circuit for the heating system

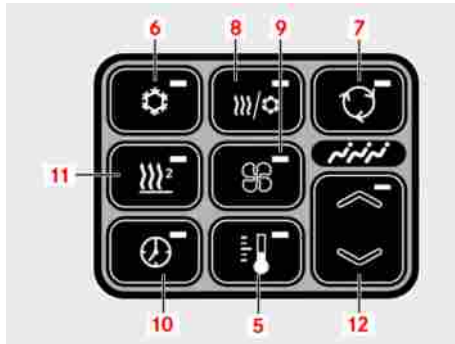

M83.00-0901-71

- ▶ Start the filling program. The filling program is started with the ignition starter switch in the OFF position. Press and hold Smog button (7) and rocker switch (12) on the control panel simultaneously. Turn the ignition starter switch to the ON position (position 2). Keep Smog button (7) and rocker switch (12) pressed until the LEDs in buttons (6, 7, 8, 11) light up. The LED in rocker switch (12) flashes.

i Note:

The filling program is divided into 3 stages. You can switch to the next program stage using rocker switch (12). An LED on the right-hand section of the control panel goes out as each program stage is completed. There is a forced pause of 10 seconds between each stage. The pause lasts 6 minutes in stage 2. It is not possible to switch to the next stage until the forced pauses have elapsed (LED in rocker switch (12) starts to flash). From program stage 2 onwards, the engine must be running, otherwise it is impossible for the program to proceed. In program stages 2 and 3, set an elevated idling speed (approximately 750 rpm) using the retarder lever (refer to the retarder lever operating instructions).

i Note:

The coolant level in the engine coolant expansion tank must be checked, and topped up if necessary, during and after each program stage.

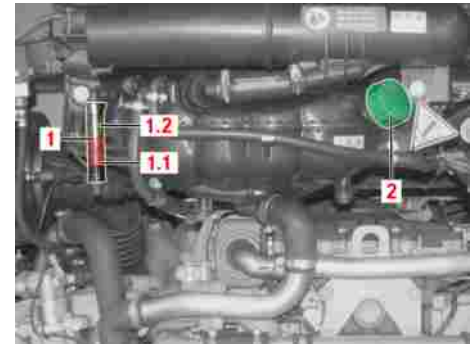

M54.00-2108-71

- ▶ Program stage 1 (LEDs in buttons 6, 7, 8, 11 light up, engine off): Add coolant at filler opening (1) until the expansion tank is completely filled with coolant. Press rocker switch (12) on the control panel - the LED in button (6) goes out.

i Note:

Use clean water - well filtered and as soft as possible (drinking water quality) - mixed with corrosion inhibitor/antifreeze (comply with the Specifications for Service Products).

Bleeding the coolant circuit for the heating system

 **Danger.**

If no corrosion inhibitor/antifreeze is available, pure water may be used temporarily (drinking quality). The bus must be driven to the nearest OMNIplus Service Partner to have corrosion inhibitor/antifreeze added to the coolant in the specified ratio (refer to the “Practical advice” section). Automatic heating/ventilation/air-conditioning mode must be disabled at the HVAC control panel (LED in the A/C button not lit) to prevent the air-conditioning system from being switched on (refer to the “Heating/ventilation/air-conditioning” section for notes on operation).

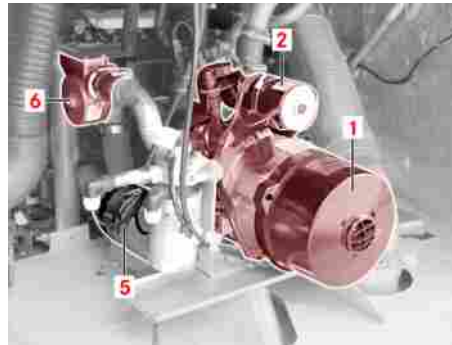

M83_00-0403-01

- ▶ Program stage 2 (engine running at an elevated idling speed of approximately 750 rpm/duration approximately 6 minutes): Recirculation pumps (2, 5) and auxiliary heating unit (1) are switched on. Bleed the coolant circuit and fill up the coolant expansion tank completely with coolant.

 **Danger.**

Risk of injury. Take particular care around hot, rotating and moving parts.

 **Note:**

Risk of fire and burns. There is a risk of fires and burns due to the high exhaust temperatures and the hot exhaust pipe for the auxiliary heating. For this reason, do not stop or park the bus over ignitable materials (e.g. grass) when the auxiliary heating is in operation, has recently been in operation or has been operated by the instant heating button/preset timer.

 **Danger.**

Risk of poisoning and asphyxiation. The auxiliary heating must not be used in enclosed spaces such as garages or workshops due to the risk of poisoning and asphyxiation. Timer and preselection mode are similarly prohibited.

Bleeding the coolant circuit for the heating system



Danger.

Risk of fire. The auxiliary heating must remain switched off in places where ignitable vapours or dust can accumulate (e.g. in the vicinity of filling stations, fuel depots, or coal, sawdust or grain stores or similar).

heating unit are switched on. Bleed the coolant circuit and fill up the coolant expansion tank completely with coolant.

- ▶ Press rocker switch (12) on the control panel - the LEDs in buttons 7 and 11 go out and the filling program is ended.

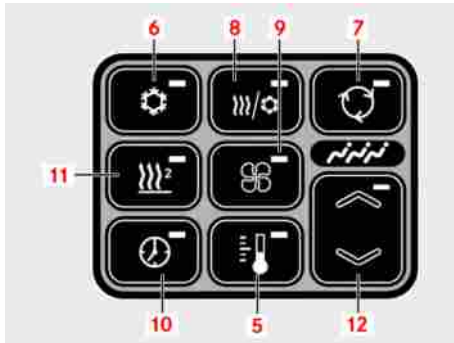

M83.00-0901-71

- ▶ Press rocker switch (12) on the control panel - the LED in button (8) goes out. Program stage 3 (engine running at an elevated idling speed of approximately 750 rpm): The recirculation pumps and the auxiliary

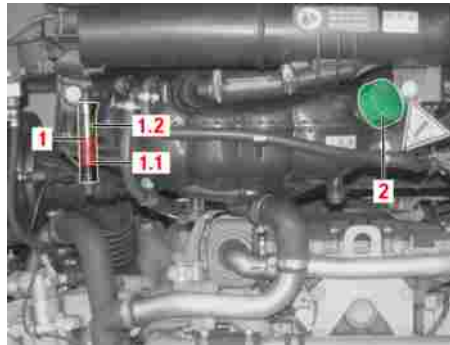

M54.00-2108-71

- ▶ Read off the coolant level and fill up to maximum mark (1.2).

Vehicle data	496
Overview of bulbs	497

Vehicle data

Vehicle data	
Designation	Value
Vehicle length	15 RHD: 12,140 mm 16 RHD-2: 12,960 mm 16 RHD: 12,960 mm 17 RHD: 13,990 mm
Vehicle width	2,550 mm
Vehicle height (including air-conditioning system)	Approximately 3,620 mm
Permissible gross vehicle weight (depending on the country of registration - e.g. Germany)	15 RHD: 18,000 kg 16 RHD-2: 18,000 kg 16 RHD: 24,000 kg 17 RHD: 24,000 kg

Designation	Value
Technically permissible front axle loads (depending on the country of registration, operation, etc. - e.g. Germany)	15 RHD: 7,100 kg 16 RHD-2: 7,100 kg 16 RHD: 7,100 kg 17 RHD: 7,100 kg
Technically permissible driven axle loads (depending on the country of registration, operation, etc. - e.g. Germany)	15 RHD: 11,500 kg 16 RHD-2: 11,500 kg 16 RHD: 11,500 kg 17 RHD: 11,500 kg

Designation	Value
Technically permissible trailing axle loads (depending on the country of registration, operation, etc. - e.g. Germany)	16 RHD: 5,750 kg 17 RHD: 5,750 kg
Wheelbase 1st-2nd axle	15 RHD: 6,080 mm 16 RHD-2: 6,900 mm 16 RHD: 6,080 mm 17 RHD: 7,110 mm
Wheelbase 2nd-3rd axle	16 RHD: 1,350 mm 17 RHD: 1,350 mm

Designation	Value
Turning circle (w to w)	15 RHD: 20,980 mm
	16 RHD-2: 23,070 mm
	16 RHD: 21,190 mm
	17 RHD: 23,670 mm
Front overhang	2,760 mm
Rear overhang	15 RHD: 3,300 mm
	16 RHD-2: 3,300 mm
	16 RHD: 2,770 mm
	17 RHD: 2,770 mm
Total fuel tank volume	RHD: approx. 440 l

Designation	Value
AdBlue additive tank volume	RHD: approx. 40 l
Windscreen washer reservoir	approx. 22 l

Overview of bulbs	
Designation	Value
Main-beam headlamps, front foglamps	24V 70W H1
Dipped-beam headlamps	24V 70W H7
Clearance lamps, front lower	24V 5W glass base
Clearance lamps, front upper	LED
Turn signals, front and rear lower	24V 21W BA15 yellow
Rear turn signals and brake lamps, reversing lamps, rear foglamps	24V 21W BA15
Lower tail lamps	24V 5W BA15

Overview of bulbs

Designation	Value
Licence plate lamps	LED
Side marker lamps	LED
End outline marker lamps	24V 4W T8/4
Centre aisle overhead lighting	T5 F35W fluorescent tube
Centre aisle low-level lighting	LED
Reading lamps	24V 10W BA15
Night lighting	LED
Service call lamp	LED
Doorway lamps	24V 20W halogen
Driver's area lighting	24V 10W halogen

Designation	Value
Lavatory lighting	24V 8W fluorescent tube

2

230/400 V systems (option)

Safety precautions 70

A

Acceleration skid control (ASR) . . 54

Activating the slip increase
function 58

Accident data recorder

Pushbutton 157

Accident data recorder (ADR)

Function description 47-48

AdBlue®

Service product 37-38

ADR button

Accident data recorder 91, 168

Air suspension

Safety precautions 142

Air-conditioning system

Operating instructions 218

Safety precautions 10

Attendant call system 91, 159

Activating 148

Automatic speed limiter

Function description 209

Auxiliary heating

Safety precautions 10-11

Auxiliary heating unit

Activating 229-230

Activating a programmed
switch-on time 233

Deactivating an activated
switch-on time 234

Programming switch-on
times 231-232

Programming the switch-on
duration 235

Auxiliary switch panel 434-435**Axle load transfer** 144

Switch 154

B

Ball hitch trailer coupling

Fixed 32

Batteries

Disconnecting 466-467

Recharging 468

Safety precautions 422

Battery compartment 442**Battery isolating switch** . . . 428-429**Bi-xenon headlamps**

Adjusting the headlamps for
driving on the left or right 477

BlueTec® exhaust gas cleaning system 35-36**Brake Assist** 54**Brakes with anti-locking protection** 50**Braking and stopping** 49**Bus**

raising/lowering 142

Bus stop brake 95, 166

Activating/deactivating 145

Emergency release
switch 95, 167, 419

C

Care and cleaning

Covers, upholstery and ceiling . . . 77

Fabric covers 78-79

Leather covers 81-83

Light-alloy wheels 76

Micro-fibre covers 80

Safety precautions 75

- CC pump**
 Greasing the impeller 361
- Ceiling switch panel** 438-439
- Central locking**
 Left-side luggage compartment 92, 162
 Right-side luggage compartment 92, 163
 System description 251-253
- Changing bulbs** 472-476
- Checking the residual current device** 360
- Compressed-air system**
 Charging another bus 417-418
- Coolant level of the engine and heating system**
 Checking 389
- Cruise control**
 Activating 214-215
- D**
- Daytime driving lights** 92, 123
- Deactivating creep mode** ... 92, 155
- Departure check**
 Daily tasks 14
- Monthly tasks 16
 Weekly tasks 15
- Destination display**
 Control panel 104-105
- Diesel particulate filter**
 Important information 40-41
 Regeneration 42-43
- Display control**
 Pushbutton 91, 156
- Door pushbutton**
 Door I 95, 167
 Door II 95, 167
- Door pushbutton in the driver's area** 106, 241
- Doors**
 Anti-entrapment protection (reversing) as the doors are closed 242
 Emergency valve operation 255-256, 478
 Protection against entrapment in the door opening direction ... 242
- Drive belts**
 Fitting 386-388
 Removing 384-385
- Driver's area**
 Overview 88
 Switches on the left section of the instrument panel 89-92
 Switches on the right section of the instrument panel 94-95
- Driver's area heating**
 Emergency operation 482
- Driver's area interior switch panel** 430-431
- Driver's area lighting** 91, 156
- Driver's power window** 91, 160
- Driver's rest area**
 Overview 110-111
 Switches/controllers 236-237
- Driver's seat**
 Grammer 172-173
 ISRI 6860/875 174-175
- Driver's seat microphone** ... 92, 164
- Driver's window heating/mirror heating** 92, 161
- Driving** 25
- Driving systems**
 Automatic speed limiter 209

- Combined drive/brake cruise control 213
 Overview 208
 Variable speed limiter (Temposet) 210
- E**
- EBS brake system** 53
- Electrical system**
 Measures required for the prevention of damage 423-424
 Overview 426-427
 Safety precautions 421
- Electronic Stability Program (ESP)**
 Deactivating 64
 Function description 62-63
 Switch 91, 154
 System description 55
- Emergency braking** 49
- Emergency hammer** 108-109
- Emergency mirror**
 Fitting 481
- Engine**
 Starting 23-24
 Stopping 26
- Engine oil level**
 Checking with the dipstick 382
- Engine oil level display** 376
- Exterior flaps**
 Overview 118
- F**
- Fire detection system**
 Description 119
- Fire extinguishers** 107
- First-aid kit** 107
- Fresh water tank**
 Draining 293
 Filling inside the bus .. 272-273, 323
 Filling outside the bus 274, 324
- Fuel consumption indicator** 140-141
- Fuel system**
 Bleeding 420
- Fuse assignment**
 Auxiliary switch panel 448-450
 Ceiling switch panel 460-461
 Driver's area interior switch panel 444-445
 Main switch panel (under the driver's area) 446-447
- Power distribution board (PDB) 456-458
- Roof-mounted heating, ventilation and air-conditioning system (Konvekta) 464
- Roof-mounted heating, ventilation and air-conditioning system (Webasto) 462-463
- Fuses**
 Handling 465
- H**
- Hazard warning lamps** 95, 166
- Heating system coolant circuit**
 Bleeding 491-494
 Cleaning the water filter ... 489-490
- Heating/ventilation/air-conditioning**
 Activating the air-conditioning .. 227
 Activating the reheat function .. 228
 Control panel 95, 220-222
 Filter maintenance 484-485
 Manually regulating the blower speed in the driver's area 223
 Manually regulating the blower speed in the passenger compartment 226

- Preselecting the passenger-compartment temperature . . . 224-225
- Scopes of maintenance for the air-conditioning system . . . 486-488
- Horn changeover** 92, 162

I

- Identification plate** 1-2
- Ignition switch** 89, 129
- Instrument cluster** 96-97
- Instrument cluster display screen**
 - Basic settings menu 131
 - Brightness setting 132
 - Description 133-139
 - Operating, function and malfunction displays 368-375

Intercom

- Driver's rest area/kitchenette 92, 165
- Hanging up 92, 164

J

- Jump seat** 176
- Jump-starting**
 - Note 468
 - Procedure 469

L**Lavatory**

- Emptying the fresh water storage tank 357
- Enabling 350-351
- Enabling switch 92, 163
- Switchover between water (WC) and chemical (CC) operation . . . 352

Locking

- Door 1 249
- Door 2 248
- Using the radio remote control (option) 250

Luggage compartment flaps

- Emergency unlocking . . . 257, 479-480

M**Master safety switch**

- (emergency-off switch)** 89, 152

- Mirror adjuster** 91, 153

N

- Night lighting** 91, 158

- Normal level** 92, 160

- Pushbutton 143

- Note symbols** 4

O**On-board diagnostics**

- Activation 470
- Clearing the fault memory 472
- Ending on-board diagnostics . . . 472
- Interpreting the screen display . . 471

On-board kitchenette

- Checking and cleaning the fresh water filter 274, 324
- Enabling switch 92, 163
- First use 270, 320
- General information . . . 266, 308, 319
- Malfunctions 300, 342
- Operation 275, 325
- Replacing fuses . . . 298-299, 339-341
- Switching off 305-306, 346-347
- Switching on 271, 321-322
- Winter operation 293, 336

Open-jaw trailer coupling and ball hitch trailer coupling

- Detachable 32

Operating/malfunction displays

- ABS/ASR 59-61
- Brake system 56-57, 65-69

Central locking	254
Doors	243-244
Fire detection system	119-120
Fuel system/exhaust gas cleaning system	46
Steering	420
Overview of bulbs	497-498

P

Parking brake

Applying	51
General information	89, 130
Releasing	52

Passenger seat

Adjusting	177
-----------	-----

Passenger seat service set

	182-183
--	---------

Passenger stop request system

	92, 161
--	---------

Passenger-compartment heating

Emergency operation	483
---------------------	-----

Passenger-compartment lighting position I+II

	91, 157
--	---------

PDB fuse switch panel

	436-437
--	---------

Pedal-activated continuous braking

Switch	95, 165
--------	---------

Pneumatic test ports

Axle modulator/door 2	416
Behind door 2	414-415
Under the driver's area	412-413

Positioning the jack

	399
--	-----

PSH (pneumatic shift aid) transmission shift system

Operation	187
-----------	-----

R

Raising/lowering the bus

	92, 160
--	---------

Reading lamps

	91, 157
--	---------

Refrigerator

On-board kitchenette	112-113
Tour guide	114-115

Refuelling

AdBlue®	39
Diesel fuel	34

Reverse warning feature

	91, 159
--	---------

Roof hatches

Emergency exit	260-261
Opening/closing manually	259
Pushbutton	91

Roof-mounted system (heating, ventilation, air-conditioning)

Electrical connection	440-441
-----------------------	---------

Rotary light switch

	92, 123
--	---------

Running-in guideline

	23
--	----

S

School bus operation

	91, 159
--	---------

Seat belt

Driver's seat	178
Jump seat	178
Passenger-compartment seating	179

Seat belt reminder

	117, 180
--	----------

Seat squab

Fitting	179
Removing	179

Service cover

	258
--	-----

Skibox

Additional operating instructions	74
fitting	71-72
swivelling	73

Snow chains

	397
--	-----

Spare mirror

	108
--	-----

Spare wheel

	398
--	-----

Steering

Important information 147

Steering column

adjusting 89, 129

Steering column switch

Light and wiper functions . . 89, 124

Retarder and cruise control . 124-128

Storage space for hand luggage . . . 9**Switch panel under the driver's area (main switch panel)** 432-433**T****Tachograph**

DTCO 89, 100-101

Installation position 98

Toilet

Emptying the solid waste container 358

Filling the fresh water storage tank 356

Operation, maintenance 353

Winter operation 359

Tools and emergency equipment 107**Tow bar** 108**Towing and tow-starting** 27-29**Trailer towing** 30

Driving with a trailer 31

Loading a trailer 31

Power supply 33

Trailer coupling maintenance 33

Transmission shift system

Safety precautions 186

Selector lever 190

Transmission shift system (GO 250-8 PowerShift)

Failsafe mode 203-206

Operation 191-202

Transmission shift system (GO 250-8)

System description 187-188

Tyre pressure monitor 395**Tyre pressures table**

295/80 R 22.5 394

Tyres

Flat tyre 396

Inflating using the tyre

inflator connection 409-411

Invisible tyre damage 392

Operating safety and roadworthiness 390

Retreaded tyres 393

Tyre age 392

Tyre condition 392

Tyre load capacity, top speed of tyres and types of tyres 393

Tyre pressure 391

Tyre tread 391

U**Unlocking**

Door circuit at the front right door 245

Door circuit using the radio remote control (option) 246

Door 2 246

Luggage compartment flaps using the pushbuttons in the driver's area 247

Luggage compartment flaps using the remote control (option) 248

V**Variable speed limiter (TempoSet)**

Activating 211-212

Vehicle data 496

W

Water heater fuel filter

Replacing 421

Wheel trims

fitting 408

removing 400

Wheels

Fitting 406-407

Removing 401-405

Windscreen heating 92, 162

Windscreen roller sunblind . . 91, 153

Windscreen washer reservoir . . . 116