

02.2014 EvoBus GmbH

Not to be reprinted, reproduced or translated in any form without prior permission.

Address for orders:

EvoBus GmbH
Service Documentation
D-89231 Neu-Ulm

Printed in Germany

Order no.: A 634 584 85 71

Introduction

The user information documents supplied with each bus are intended for use only by those persons who are qualified to operate the bus. The user information is divided into the following parts:

- The Operating Instructions are designed to answer all important questions concerning the operation of chassis components.
- The Maintenance Record is our guide to the technical care of chassis components. It contains all the information on maintenance intervals and maintenance tasks as well as pages for confirming that the maintenance work has been carried out.

Please make sure that you read the “Safety” section before you operate the vehicle for the first time. Before the bus is driven, please make sure that you

have read and understood the contents of these Operating Instructions.

Our user information describes items of chassis equipment that form part of the standard specification. Items of optional equipment are also described, if their operation needs explanation. As the bus delivered to you has been customised in accordance with your particular order, the actual equipment and features of your bus may not always match the descriptions and illustrations presented here. If the body manufacturer has modified any part of the chassis, the body manufacturer is responsible for providing the description of these modifications. The Operating Instructions and the Maintenance Record are important documents and must always be carried in the bus.

Our buses are subject to ongoing development. You are therefore asked to appreciate that we reserve the right to make modifications to the design, equipment and technical features. For these

reasons, no claims can be made based upon the contents of this user information.

Environmental protection:

The declared policy of EvoBus GmbH is one of integrated environmental protection. This policy starts at the root causes and encompasses in its management decisions all the consequences for the environment which could arise from production processes or the products themselves.

The objectives are for the natural resources which form the basis of our existence on this planet to be used sparingly and in a manner which takes the requirements of both nature and humanity into account. You, too, can help to protect the environment by operating the bus in an environmentally friendly manner. Fuel consumption and wear in the drive train (engine, clutch, transmission, axles, brakes, tyres) are extremely dependent on your driving style.

We hope you enjoy driving your bus.

EvoBus GmbH

Mercedes-Benz Omnibusse

Vehicle identification	1	Towing the bus	21	Acceleration skid control (ASR) (option)	45
Safety	3	Tow-starting the bus	22	Bus stop brake (option)	46
General safety information	4	Refuelling (diesel fuel)	22	Bus stop brake with drive-off lock (option)	47
Fire-prevention measures	7	BlueTec® exhaust gas cleaning system	24	Brake system supply pressures	49
Operation of auxiliary heating	8	AdBlue® service product	26	Continuous brakes operating information	50
Definition of the sales designation	8	Filling with AdBlue®	28	Displaying the engine operating hours	54
General	9	Diesel particulate filter	31	Care and cleaning	55
Preparation for the journey - daily tasks	10	Diesel particulate filter regeneration	33	At a glance	59
Preparation for the journey - weekly tasks	11	Starting regeneration of the diesel particulate filter manually	34	Instrument display panel	60
Maintenance work	11	Operating/malfunction displays: fuel system	36	Warning and indicator lamps	64
Operation	13	Brake system safety precautions	37	On-board computer	66
Running in	15	Braking and stopping	38	On-board computer control rocker switch	70
Starting the engine	15	Brakes with anti-locking protection	38	DTCO tachograph	72
Starting the engine using the pushbutton (option)	17	Applying/releasing the parking brake	39	MTCO tachograph	74
Driving	18	Emergency braking in the event of failure of both brake circuits	40	Vehicle tool kit and emergency equipment (option)	76
Stopping the engine	19	Deactivating the Electronic Stability Program (ESP)	41	Auxiliary heating preset timer (option)	78
		Brake system (BS)	42		
		Anti-lock braking system (ABS)	43		

Table of contents

Driver's area controls 81

Rotary light switch 83

Combination switch for lights and wiper functions 83

Combination switch for continuous brakes and cruise control (option) 86

Adjustable steering column 90

Ignition starter switch 91

Parking brake valve 91

3-button automatic transmission gearshift unit 94

6-button automatic transmission gearshift unit (option) 96

Instrument display panel 97

Screen sequence at start-up 104

Display fields on the on-board computer display screen 105

Adjusting the instrument lighting 107

Malfunction displays: Description 108

Malfunction displays: red warning level - description 109

Malfunction displays on the on-board computer display screen with red status indicator - overview 112

Malfunction displays: yellow warning level - description 113

Malfunction displays on the on-board computer display screen with yellow status indicator - overview 116

Malfunction displays: STOP lamp - description 118

Malfunction displays on the on-board computer display screen with red STOP warning lamp - overview 120

Display screen symbols 121

Vehicle manoeuvrability with the air suspension depressurised 128

Air suspension versions 128

Lowering the bus on the boarding side (kneeling) (option) 129

Raising the bus body to driving ride height 2 (option) 130

General Information / Safety Information 131

Turning the steering wheel when the bus is stationary 131

Switch descriptions 133

Instrument panel switches and pushbuttons 134

Acceleration skid control (ASR)/ Electronic Stability Program (ESP) OFF 138

Diesel particulate filter (DPF) regeneration start/inhibit 138

Master safety switch (country-specific) 139

Transmission shift systems 141

Operation 142

Heating/ventilation/air-conditioning 147

Auxiliary heating preset timer (option) 148

Operating the auxiliary heater (option) 149

<hr style="border: 2px solid orange;"/>	
Driving systems	153
Driving systems (overview)	154
Variable speed limiter (Temposet)	154
Activating the variable speed limiter (Temposet)	155
Combined drive/brake cruise control	157
Activating combined drive/brake cruise control	158
Operating/malfunction displays: driving systems	159
Engine speed increase	162
<hr style="border: 2px solid red;"/>	
Practical advice	165
Safety precautions for work carried out in the engine compartment	168
Electric fuel pump (option)	168
Checking the engine oil level with the dipstick	169
Checking the coolant level of the engine and heating system	170
Removing the drive belts (OM 936)	171
Fitting the drive belts (OM 936)	173
Tyres - operating safety and roadworthiness	177
Tyre pressure	177
Tyre tread	178
Tyre condition	178
Tyre age	178
Invisible tyre damage	179
Tyre load capacity, top speed of tyres and types of tyres	179
Retreaded tyres	180
Tyre pressures table 275/70 R 22.5	182
Tyre pressures table 11 R 22.5	184
Tyre pressures table 295/80 R 22.5	186
Safety measures to be taken in the event of a flat tyre or a wheel change	187
Positioning the jack	188
Removing the wheel trims	189
Fitting a wheel nut cover cap	189
Removing a wheel	191
Fitting wheels	191
Inflating tyres using the tyre inflator connection	193
Pneumatic test ports	196
Charging the compressed-air system (option)	197
Checking the oil level in the steering hydraulics expansion tank	198
Replacing the fuel filter for the auxiliary heater (option)	199
Electrical system safety precautions	201
Safety precautions for handling batteries	201
Measures required for the prevention of damage to buses or components during electric welding work	202
Fuse assignment for driver's area switch panel	204
Fuse assignment (main fuses) for auxiliary switch panel	208
Handling fuses	210
Disconnecting vehicle batteries	211
Recharging vehicle batteries	212

Table of contents

Notes on jump-starting	212
Jump-start procedure	213
On-board diagnostics	214

Technical data

Chassis technical data	218
------------------------------	-----

Index

Vehicle identification number (VIN) (1) is stamped on the cross member to the rear of the driven axle or on the longitudinal frame member in the right-side wheel arch (option).



Note:

It is very important to identify the bus exactly so that the correct technical data can be applied.

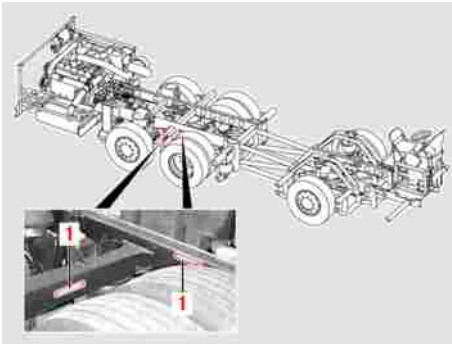

M00_00-0506-71

No.	Designation	Value

General safety information	4
Fire-prevention measures	7
Operation of auxiliary heating	8
Definition of the sales designation	8

General safety information

General safety information

The use of symbols and their meanings

Safety precautions and other important information are highlighted by symbols.

In addition to the instructions provided herein, all generally applicable safety and accident prevention regulations must also be observed, e.g. in Germany, the rules and regulations of the institutions for statutory accident insurance and prevention.

Instructions and information printed on the packaging for components, tools and service products must also be observed.

Where information and instructions are to be observed, it is assumed that the user information is intended for persons who are suitably qualified to carry out the tasks by nature of their education, training and experience.

These persons should, at the same time, be able to identify risks that may arise in the undertaking of their tasks and take the necessary measures to avoid them.

Meaning of symbols:



Danger.

Warning notes for risks to persons



Caution:

Warning notes about damage that may occur in the event of non-compliance



Note:

Notes about important additional information



Environmental protection

Notes about environmental protection measures

▷ Reference to more detailed and additional user information

Notes on vehicle safety

Use only genuine parts that are OMNIplus quality tested and conversion parts and accessories that have been expressly approved by EvoBus for the bus model concerned in order to rule out the possibility of jeopardising road safety and invalidating the warranty and general operating permit.

These parts have been specially tested for their safety, reliability and suitability. You can obtain further information from any OMNIplus Service Partner.

Operating safety

Any work or modifications that have been carried out on the chassis incorrectly may result in malfunctions.

Tampering with electronic components and their software may cause malfunctions. As electronic components are networked, these malfunctions may also cause other, indirectly related systems to malfunction. These malfunctions may jeopardise the operating safety and reliability of the bus.

Retrofitted electrical or electronic devices must possess type-approval complying with Directive 95/54/EC or ECE Directive 10/02.

Materials that are introduced to the bus as a result of installations, conversions or modifications and that are subject to mandatory fire-testing requirements must satisfy the requirements of EU Directive 95/28/EC.

Materials and components of seats and seat fixtures that are introduced to the bus as a result of installations, conversions or modifications must satisfy the requirements of the following directives: 76/115/EEC as amended by 96/38/EC, 74/408/EEC as amended by 96/37/EC, 77/541/EEC as amended by 96/36/EC

At the time of purchase or installation, it must be checked that these materials and components have been certified accordingly. The use of materials or components that have not been granted the relevant certificate may result in the operating permit being invalidated.

We recommend that you have work or modifications carried out by an OMNIplus Service Partner.

EU Directive 2001/85

Registration as class 1: city bus

- Vehicles constructed with areas for standing passengers, to allow frequent passenger movement.

Registration as class 2: interurban bus

- Principally for the carriage of seated passengers. Designed to allow the carriage of standing passengers in the gangway and/or in an area which does not exceed the space provided for two double seats.

Registration as class 3: tourist coach

- Exclusively for the carriage of seated passengers.

Important information for buses classified in accordance with EU Directive 2001/85 into class 2 and 3 (mixed approval):

- The operator of the bus is responsible for ensuring that the bus is restored to the condition consistent with the permissible type of operation of the class concerned.
- For instance, this means that, in the case of a bus being used in accordance with class 2, it is necessary to ensure that the bus is operated with seating having no aisle-side sideways adjustment.

Navigation and global positioning system

If your bus is equipped with a navigation system, you should observe the following instructions and information:

General safety information



Danger.

Always devote your attention primarily to road and traffic conditions. Do not attempt to operate the navigation and positioning system unless the bus is stationary. Please bear in mind that your bus will cover a distance of 14 metres every second at a speed of only 50 km/h.



Caution:

The navigation system is unable to take into consideration the maximum load-bearing capacity of bridges or the required headroom clearance for underpasses. The driver is responsible for checking the load-bearing capacity of bridges and headroom clearances encountered en route.

Operation of radio and mobile communications equipment

e.g. telephone, two-way radio, fax machine, etc.



Danger.

Always devote your attention primarily to road and traffic conditions. Do not operate the display unit, radio or mobile communications equipment unless the traffic situation permits this to be done safely. Please bear in mind that your bus will cover a distance of 14 metres every second at a speed of only 50 km/h.



Caution:

Observe local legal requirements governing the use of mobile phones or on-board telephones/intercoms in force in the country of vehicle operation.

Operation of mobile phones and two-way radios without an exterior aerial

We advise against making or receiving telephone calls in buses not equipped with an exterior aerial as the operation of radio transmitters, which include but are not limited to radio telephones (mobile phones), may cause inadequately

shielded equipment (cardiac pacemakers included) to malfunction.



Note:

If a mobile phone, radio system or fax machine is retrofitted in the bus in a manner that does not comply with EvoBus installation specifications, the operating permit for the bus may be invalidated (EU Directive 95/54/EC).



Note:

Older peripherals (e.g. ticket-printing machines, ticket-cancelling machines, destination displays, etc.) that are still used in new buses must comply with the technical requirements of EC Directive 72/245 EEC.



Caution:

Observe local legal requirements governing the use of mobile phones or on-board telephones/intercoms in force in the country of vehicle operation.

Stickers

There are various warning stickers affixed to your bus. These are intended to make you and others aware of various dangers. Therefore, do not remove any stickers unless it is expressly stated on the sticker that you may do so.



Danger.

If you remove warning stickers, this could result in you or other persons failing to recognise dangers. You or others could be injured as a result.

Fire-prevention measures

Pre-drive measures:

- Check tyre pressures (daily visual check/weekly measurement)
- Check that twin tyres are spaced sufficiently apart

On-road measures:

- Monitor coolant temperature

Post-drive measures:

- Inform a mechanic/next driver about malfunction, if applicable

Parking the vehicle:

- Switch the battery isolating switch to OFF



Caution:

Risk of fire and burns. There is a risk of fires and burns due to the high exhaust temperatures and the hot exhaust pipe for the auxiliary heating. For this reason, do not stop or park the bus over ignitable materials (e.g. grass) when the auxiliary heating is in operation, has recently been in operation or has been operated by the instant heating button/preset timer.



Caution:

Risk of fire and burns. Regeneration of the diesel particulate filter is associated with very high temperatures. For this reason, before regeneration is initiated manually, make sure that there are no flammable materials near the exhaust pipe and exhaust system.

Operation of auxiliary heating

Operation of auxiliary heating



Danger.

Risk of fire and burns. There is a risk of fires and burns due to the high exhaust temperatures and the hot exhaust pipe for the auxiliary heating. For this reason, do not stop or park the bus over ignitable materials (e.g. grass) when the auxiliary heating is in operation, has recently been in operation or has been operated by the instant heating button/preset timer.



Danger.

Risk of poisoning and asphyxiation. The auxiliary heating must not be used in enclosed spaces such as garages or workshops due to the risk of poisoning and asphyxiation. Timer and preselection mode are similarly prohibited.



Danger.

Risk of explosion. The auxiliary heating must be switched off at filling stations and fuel dispensing systems due to the risk of explosion.



Danger.

Risk of fire. The auxiliary heating must remain switched off in places where ignitable vapours or dust can accumulate (e.g. in the vicinity of filling stations, fuel depots, or coal, sawdust or grain stores or similar).



Caution:

The heater must be operated for 10 minutes at least once a month (also during the warm season) when the engine is cold.

Definition of the sales designation

e.g. OC 500 LE 1825h

OC - Omnibus Chassis

500 - series designation

LE - Low Entry

18 - permissible gross weight in tonnes

25 - approximate engine output in hp/10
(approximately 250 hp)

h - horizontal engine orientation

Preparation for the journey - daily tasks 10

Preparation for the journey - weekly tasks 11

Maintenance work 11

Preparation for the journey - daily tasks

Preparation for the journey - daily tasks



Note:

For further information, refer to the “Practical advice” section.

- ▶ Check the fuel level for the engine and auxiliary heating.



Caution:

Switch off the engine and auxiliary heating before refuelling.

- ▶ Check the AdBlue® additive level in the BlueTec® exhaust gas cleaning system.

- ▶ Insert the tachograph recording disc or the driver card.



Note:

If the indicator lamp in the tachograph is lit, no disc or driver card has been inserted.

- ▶ Check tyre pressures and tyre condition (including the spare wheel). Check that the wheel nuts are firmly seated.

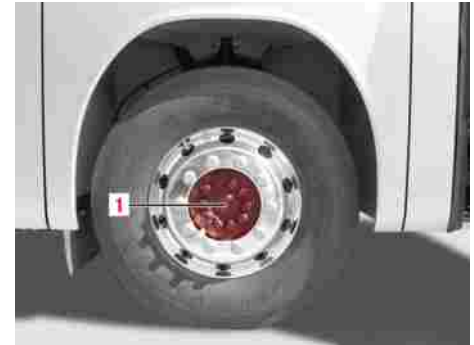

M40_00-0115-71

- ▶ Check wheel hubs (1) on all wheels for leaks inside and out (visual check).



Note:

If the wheel hubs are leaking, there may be grease or oil residue on the tyres or deposits on the parking area on which the bus is standing. Consult an OMNIplus Service Partner in the event of a leak.

Preparation for the journey - weekly tasks

Preparation for the journey - weekly tasks

**Note:**

For further information, refer to the “Practical advice” section.

- ▶ Check the coolant level in the cooling system and top it up if necessary. Check the corrosion inhibitor/anti-freeze concentration each time the coolant has been topped up and correct if necessary.
- ▶ Check the oil level in the hydraulic steering system and top it up if necessary.
- ▶ Check tyre pressures and tyre condition (including the spare wheel). Check that the wheel nuts are firmly seated.
- ▶ Check the condition of all drive belts.

- ▶ Carry out a visual check to ensure there are no leaks in the engine, transmission, driven axle, steering or cooling system.
- ▶ Drain the fuel prefilter in the engine compartment.
- ▶ Check the acid level in the starter batteries.

Maintenance work

- ▶ Carry out the work specified in the Maintenance Record.

**Caution:**

Regular maintenance of the chassis and drive train is essential to maintaining the operating safety and roadworthiness of the bus. The time intervals and the scope of work required are specified in the Maintenance Record supplied with the bus.

**Note:**

Warranty claims based on our terms and conditions of sale and delivery may be rejected if the periodic maintenance tasks have not been carried out at the specified distances or times. Have confirmation of the completed work recorded in the Maintenance Record by an OMNIplus Service Partner.

Running in	15
Starting the engine	15
Starting the engine using the pushbutton (option)	17
Driving	18
Stopping the engine	19
Towing the bus	21
Tow-starting the bus	22
Refuelling (diesel fuel)	22
BlueTec® exhaust gas cleaning system	24
AdBlue® service product	26
Filling with AdBlue®	28
Diesel particulate filter	31
Diesel particulate filter regeneration	33
Starting regeneration of the diesel particulate filter manually	34
Operating/malfunction displays: fuel system	36
Brake system safety precautions	37

Table of contents

Braking and stopping	38
Brakes with anti-locking protection	38
Applying/releasing the parking brake	39
Emergency braking in the event of failure of both brake circuits	40
Deactivating the Electronic Stability Program (ESP)	41
Brake system (BS)	42
Anti-lock braking system (ABS)	43
Acceleration skid control (ASR) (option)	45
Bus stop brake (option)	46
Bus stop brake with drive-off lock (option)	47
Brake system supply pressures	49
Continuous brakes operating information	50
Displaying the engine operating hours	54
Care and cleaning	55

Running in

**Note:**

The way in which the chassis and drive train are treated during the first 5,000 km is critical to their future performance and service life. The load to which the bus is subjected during this period should be increased only gradually. The maintenance and lubrication tasks specified in the Maintenance Record should be carried out conscientiously.

- ▶ Do not place the engine under full load during the running-in period.

**Caution:**

For the first 2,000 km, run in with care. Do not drive at any more than 3/4 of the maximum engine speed for each gear. After 2,000 km gradually increase to an economical engine speed. During the running-in period, do not drive for long distances at the same road speed/engine speed. Varying engine speeds and therefore varying loads demanded of the entire

drive train are favourable to the running-in of the bus.

Starting the engine

- ▶ The parking brake must be applied. Transmission in neutral.
- ▶ Do not depress the clutch pedal while starting the engine.

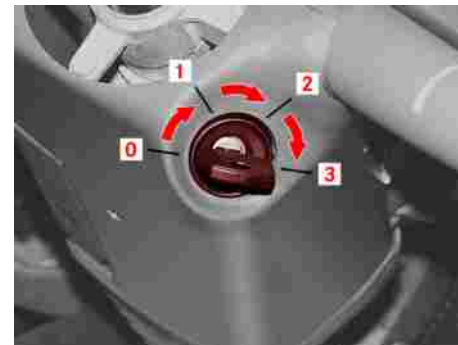

M54_00-0083-01

- ▶ Turn the ignition starter switch to position 2.

During the display check, a warning buzzer sounds for approximately 1 second. The status indicator lights up yellow. All indicator lamps assigned to items of bus equipment light up for approximately 2 seconds in the instrument panel.

Starting the engine

- ▶ Then turn the ignition starter switch to position 3 without depressing the accelerator pedal. If necessary, cancel the starting procedure after a maximum of 15 seconds and wait for about 1 minute before repeating the starting procedure. Turn the key fully back before making a further attempt to start the engine.



Note:

After a maximum of 3 starting attempts, wait (about 15 minutes) before trying again.

- ▶ Release the key when the engine starts.

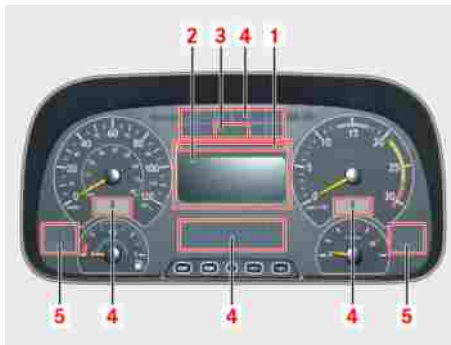

M54.00-1859-71

- ▶ Observe the instrument display panel: STOP lamp (3) must go out. The STOP lamp lights up if the engine oil pressure, the engine oil level or the compressed air in the supply system is too low or the engine temperature is too high.



Caution:

If the STOP lamp does not go out, the operating reliability of the engine is endangered. Switch off the engine immediately and determine the cause.



Danger.

A warning signal sounds for approximately 5 seconds if there is insufficient pressure in the compressed-air supply system. The "STOP" warning lamp does not go out until the required pressure has been reached. Do not release the parking brake until there is sufficient operating pressure.

Starting the engine using the pushbutton (option)

Starting the engine using the pushbutton (option)



Note:

The parking brake must be applied.
Transmission in neutral.

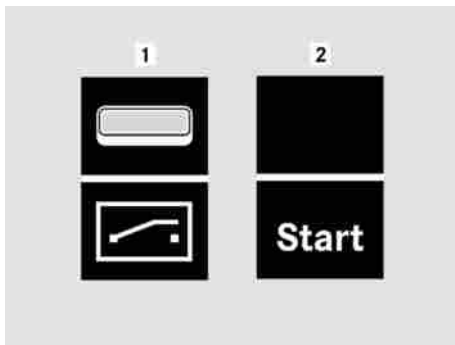

M01_00-0100-01

- ▶ Press rocker switch (1) on the instrument panel.

During the display check, a warning buzzer sounds for approximately 1 second. The status indicator lights up yellow. All indicator lamps assigned to items of bus equipment

light up for approximately 2 seconds in the instrument panel.



Note:

All controls and display elements are supplied with power after the switch has been activated.

- ▶ Then press pushbutton (2) on the instrument panel. If necessary, cancel the starting procedure after a maximum of 15 seconds and wait for about 1 minute before repeating the starting procedure.



Note:

After a maximum of 3 starting attempts, wait (about 15 minutes) before trying again.

- ▶ Release pushbutton (2) when the engine starts.



M54.00-1859-71

- ▶ Observe the instrument panel: STOP lamp (3) must go out. The STOP lamp lights up if the engine oil pressure, the engine oil level or the compressed air in the supply system is too low or the engine temperature is too high.



Caution:

If the STOP lamp does not go out, the operating reliability of the engine is endangered. Switch off the engine immediately and determine the cause.



Danger.

A warning signal sounds for approximately 5 seconds if there is insufficient pressure in the compressed-air supply system. The STOP warning lamp does not go out until the required pressure has been reached. Do not release the parking brake until there is sufficient operating pressure.

Driving



Environmental protection

Never warm up the engine by allowing it to idle with the bus stationary. Instead, drive off and operate the engine at moderate engine speeds.



Note:

The engine should not be placed under full load until it has reached normal operating temperature (75 - 90 °C, depending on operating conditions and the outside temperature).



Danger.

The freedom of movement of the pedals must not be restricted. The operating safety and roadworthiness of the bus would otherwise be at risk. Objects could fall and get caught between the pedals if you were to accelerate or brake suddenly, with the result that you would no longer be able to brake, depress the clutch ped-

al or accelerate. You could cause an accident and endanger yourself and others.

▷ For buses with automatic transmission (option), refer to the “Transmission shift systems” section.

▶ Check the freedom of movement of the pedals



Danger.

Where floor mats and carpets are fitted, make sure that these are safely secured against slipping and that the pedals have sufficient clearance.



Danger.

Do not stow any objects in the driver's footwell.



Danger.

Stow and secure all loose objects in such a way that they cannot get into the driver's footwell when the bus is in motion.

- ▶ Always pull away in 1st gear at 600 - 800 rpm.



Danger.

Test the service brake immediately after pulling away.

- ▶ Keep an eye on the rev counter while driving.



Note:

Keep within the economical range (green zone). Make sure that the engine speed does not enter the danger zone (red zone).



Danger.

Buses with manual transmission: If a warning buzzer sounds during a gearshift, the gear that you have attempted to engage is too low. In this event, be sure to keep the clutch pedal depressed and select a suitable gear for the current road speed.

Stopping the engine

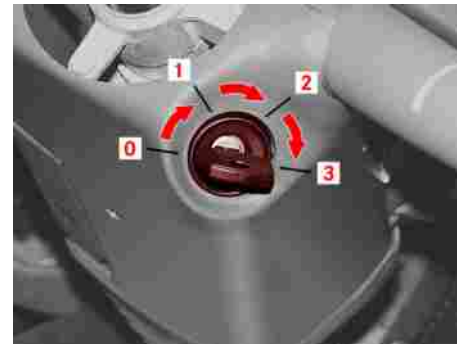

M54_00-0083-01

- ▶ Stop the bus, select transmission neutral, apply the parking brake, turn the ignition starter switch from position 2 (drive position) back to position 1.

Stopping the engine



Caution:

Before you switch off the engine, allow it to continue running at idling speed for approximately 1-2 minutes (to allow the exhaust turbochargers to cool down if the coolant temperature is high or if you have been driving at full engine output (e.g. on hilly roads)).



Note:

Never park the bus with a gear engaged. If a gear is engaged and there is a loss of compressed air, it would no longer be possible to shift the transmission to neutral and, therefore, start the bus.

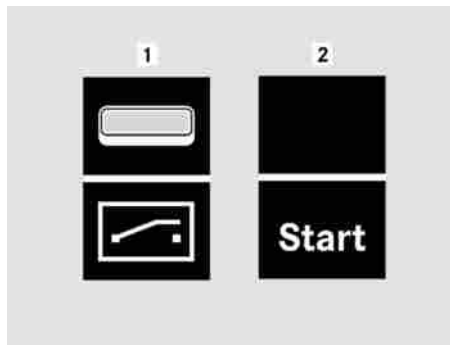

M01_00-0100-01

- ▶ If the bus is not equipped with a key switch (option), switch rocker switch (1) on the instrument panel to OFF.



Note:

The location of the switches is determined by the body manufacturer.



Note:

Whenever the switch is switched to OFF, all consumers and the engine are switched off.



Note:

To switch off, the driver has to slide the safety catch downwards and press the upper section of the switch at the same time.



Caution:

Before you switch off the engine, allow it to continue running at idling speed for approximately 1-2 minutes (to allow the exhaust turbochargers to cool down if the coolant temperature is high or if you have been driving at full engine output (e.g. on hilly roads)).

Towing the bus

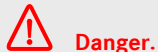
**Danger.**

Observe the instructions and guidelines issued by the body manufacturer.

**Danger.**

Only authorised specialists (recovery service) are permitted to tow away broken-down buses. The rules and regulations in the country concerned must be observed.

**Danger.**

The ignition starter switch of the vehicle being towed must always remain in position 1 during the towing procedure. The steering lock must not be allowed to engage. Failure to comply with this guideline could result in the steering locking.

**Danger.**

In buses with the Electronic Stability Program (ESP), this function must be deactivated without exception

**Danger.**

During towing, it is prohibited to press the “Engine start pushbutton” (option) on the bus being towed.

**Danger.**

The ignition starter switch must not be switched to position 2 while the front axle is raised. The wheels on the driven axle may lock. Failure to comply could result in brake intervention by the ABS/ASR system, which could cause the rear axle to skid.

**Caution:**

Special measures are required in order to protect the transmission if the bus is to be towed: In the interests of safety, the propeller shaft must always be removed. The propeller shaft securing screws at the axle flange must be removed and those at the transmission flange secured against displacement. Failure to comply could result in irreparable damage to the transmission.

**Note:**

Before removal, secure the propeller shaft against dropping.

Tow-starting the bus

Tow-starting the bus



Danger.

Observe the instructions and guidelines issued by the body manufacturer.

- Tow-starting possible only with manual transmission. Buses with automatic transmission (option) cannot be tow-started.



Note:

The bus cannot be tow-started unless the batteries are fully charged (at least 21 V).



Caution:

Always tow-start the bus with the batteries connected. Turn the ignition starter switch to the drive position. Depress the clutch pedal fully, select 2nd or 3rd gear. Have the towing vehicle pull away and then release the clutch pedal and depress the accelerator pedal until the engine starts.



Note:

Jump-starting - refer to the “Practical advice” section

Refuelling (diesel fuel)

The bus has a two-tank system fitted between and to the front of the wheels on the front axle. The fuel tanks are interconnected by a fuel line. It may be possible to refuel from either side of the bus (option). If the fuel tanks on your bus are interconnected, it is necessary to remove the fuel cap from each of the fuel tanks.

Refuel using only commercially available, sulphur-free diesel fuel complying with European standard EN 590 as revised from 2010 onwards (max. 0.001 % sulphur by weight). Fuels containing more than 0.001 % sulphur by weight or other types of fuel such as marine diesel fuel, heating oils or fatty acid methyl ester FAME (biodiesel) or pure vegetable oils are not permitted. These types of fuel would cause irreversible damage to the engine and BlueTec®6 exhaust gas aftertreatment system and considerably reduce expected service life. In the cold season, use winter-grade diesel fuel (effective down to approximately -20 °C to

-22 °C). The addition of flow improvers is not permitted.

Switch off the engine and auxiliary heating before refuelling. Park the bus on a level surface.

Cleanliness is of utmost importance when refuelling. Do not leave cotton rags or cloths in the vicinity of the open filler neck.

**Danger.**

Risk of injury and explosion. Fuel is highly flammable. Fire, naked flames and smoking are therefore prohibited when fuel is being handled.

**Danger.**

Before refuelling, switch off the auxiliary heating to prevent fuel vapours from igniting on the auxiliary heating exhaust system.

**Danger.**

Fuel is toxic and harmful to health. For this reason, make sure that the fuel does not come into contact with skin, eyes or clothing, that you do not inhale fuel vapours and that children are kept away from the fuel.

**Danger.**

If you or others have come into contact with fuel: In case of contact with the eyes, rinse them immediately and copiously with clean water and seek medical attention. Clean affected areas of skin immediately with soap and water. Immediately change out of clothing that has come into contact with fuel. If fuel has been swallowed, seek medical attention immediately.

**Environmental protection**

If handled improperly, fuels constitute a hazard to health and the environment. Fuels must not be allowed to enter the sewerage system, surface water, ground-water or soil.

BlueTec® exhaust gas cleaning system

BlueTec® exhaust gas cleaning system

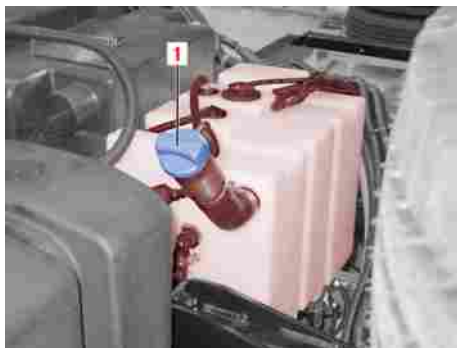

M47_00-0070-71

The BlueTec® exhaust gas cleaning system essentially comprises a supply tank, a catalytic converter and an AdBlue® metering system. It is monitored and controlled electronically. Pollutants in the exhaust gas are converted into environmentally friendly substances by the addition of AdBlue® and the catalytic converter integrated into the silencer. The illustration shows filler opening (1) of the AdBlue® supply tank.



Note:

AdBlue® is consumed at a rate of approximately 3 % of the rate of diesel fuel consumption. For this reason, it is recommended that the AdBlue® supply tank also be refilled at every regular refuelling stop.

To function correctly, the BlueTec® exhaust gas cleaning system requires the addition of a reducing agent (AdBlue®). The addition of AdBlue® does not form part of the routine scope of bus maintenance – it is the responsibility of the vehicle operators to ensure that the AdBlue® supply tank is regularly replenished. Filling and operating the bus with AdBlue® is mandatory for compliance with emission regulations and is thus one of the conditions for the road traffic approval of the bus. The road traffic approval of the bus will be invalidated if the bus is operated without AdBlue®. It would then be against the law to operate the bus on public roads. In some countries, operation of the bus without AdBlue® may be considered to be a crim-

inal offence or a violation of administrative law punishable by fine. Support in the purchase or operation of the bus, e.g. tax relief, road tax, may also be invalidated retrospectively. This may be the case both in the country in which the vehicle is registered and in other countries in which the vehicle is operated.



Danger.

It is essential that work relevant to safety or work on safety-related systems be carried out at a qualified specialist workshop.



Danger.

Always have maintenance work carried out at a qualified specialist workshop which has the necessary knowledge and tools.

**Note:**

AdBlue® freezes at a temperature of approximately -11 °C. The bus is equipped with an AdBlue® preheating system as standard. Winter operation is thus ensured, even at temperatures below -11 °C.

**Environmental protection**

AdBlue® is biologically degradable. Unless it is handled properly, however, AdBlue® constitutes an environmental hazard. Do not allow AdBlue® to enter the sewerage system, surface water, groundwater or soil in significant volumes.

**Danger. Risk of poisoning and injury.**

AdBlue® is not classified as a hazardous substance by German regulations governing hazardous substances. Nevertheless, certain points should be observed when handling AdBlue®.

The AdBlue® line system and the system components connected to it are pres-

surised while the engine is warm. There is a risk of scalding from hot AdBlue® spraying out if the line system is suddenly opened. There is also the risk of skin irritation or damage to the eyes if AdBlue® comes into contact with the skin or eyes.

- Wear gloves
- Wear protective clothing
- Wear safety goggles
- Work on the exhaust gas aftertreatment system should not be commenced until approximately 4 minutes have passed as individual lines continue to be flushed even after the engine has been switched off.
- Switch the ignition starter switch to the "OFF" position and remove the key before work is carried out on the SCR system.
- Allow the AdBlue® line system to cool down
- Open line connections and system component covers/caps slowly.
- Capture any AdBlue® that escapes in a suitable container and dispose of it in an environmentally responsible manner.

- Do not pour AdBlue® into drinks containers.
- Wipe up any spilled AdBlue®, especially as there is a risk of slipping.
- AdBlue® collected in this way must not be poured back into the AdBlue® supply tank.
- Rinse affected areas of skin copiously with clean water.
- Quickly change out of clothing that has come into contact with the substance.
- In case of contact with the eyes, rinse them immediately and copiously with clean water and seek medical attention if necessary.
- If AdBlue® enters the mouth or is swallowed, rinse the mouth out with clean water and then drink plenty of water.
- Seek medical attention if symptoms persist.

AdBlue® service product



M54.00-1860-71

If the AdBlue® service product reaches the reserve level, icon (1) appears on the display screen in conjunction with a yellow alert (2) to remind the driver that an AdBlue® top-up is due. The AdBlue® fill level can be seen on fuel gauge (3).

The driver is informed by an icon on the display screen (see illustration) in conjunction with a yellow alert if the AdBlue® supply tank runs empty or if there is a malfunction in the BlueTec® exhaust gas cleaning system. In addition, the exhaust gas cleaning system (SCR system) malfunction display flashes or lights up in the indicator lamp panel. In this

event, it is necessary to top up the AdBlue® level immediately or remedy the fault.

AdBlue® service product

AdBlue® is a non-flammable, non-toxic, colourless, odourless, water-soluble liquid.



Caution:

Use only AdBlue® complying with DIN 70070/ISO 22241. Special additives are not permitted.



Caution:

If, during a top-up, AdBlue® comes into contact with painted or aluminium surfaces, rinse down these surfaces with water immediately.

Properties of AdBlue® at high temperatures

**Note:**

Ammonia vapours may be released as a product of the decomposition of AdBlue® if the content of the AdBlue® tank heats up to over 50 °C for a lengthy period (e.g. as a consequence of direct sunlight).

**Note:**

Ammonia vapours have an acrid odour. For this reason, you should avoid inhaling any ammonia vapours that may escape when you remove the AdBlue® filler cap. Ammonia vapours are an irritant mainly to skin, eyes and mucous membranes. Ammonia vapours are neither toxic nor hazardous to health in this concentration.

Properties of AdBlue® at low temperatures

**Note:**

AdBlue® freezes at a temperature of approximately -11 °C. The bus is equipped with an AdBlue® preheating system as standard. Winter operation is thus ensured, even at temperatures below -11 °C.

AdBlue® additives

**Caution:**

Do not add any additives to AdBlue®. Do not dilute AdBlue® with tap water. Doing so could destroy the exhaust gas cleaning system. Damage to the exhaust gas cleaning system caused by additives/tap water will invalidate the warranty.

Storage of AdBlue®

**Caution:**

For the storage of AdBlue®, use only containers made from high-alloy CrNi steels or MoCrNi steels complying with DIN EN10088-1/2/3. Containers made of aluminium, copper, cupriforous alloys and non-alloyed or galvanised steels are not suitable for the storage of AdBlue®. If stored in such containers, AdBlue® could dissolve out constituents of these metals and destroy the exhaust gas cleaning system. The vehicle warranty will be invalidated if damage to the exhaust gas cleaning system is found to have been caused by constituents dissolved out of non-approved storage containers.

Disposal of AdBlue®

**Note:**

Observe country-specific legislation and requirements governing the disposal of AdBlue®.

AdBlue® purity

Filling with AdBlue®



Note:

It is prohibited to return to the tank any AdBlue® that has been pumped out, e.g. during a repair, because the purity of the liquid would no longer be guaranteed.

Filling with AdBlue®



Note:

An accidental filling of the AdBlue® supply tank with diesel fuel and vice versa is prevented by various technical precautionary measures.



Note:

AdBlue® is consumed at a rate of approximately 3 % of the rate of diesel fuel consumption. It is recommended that the AdBlue® supply tank also be refilled at every regular refuelling stop.



Caution:

Use only AdBlue® complying with DIN 70070/ISO 22241. Special additives are not permitted.



Caution:

If, during a top-up, AdBlue® comes into contact with painted or aluminium surfaces, rinse down these surfaces with water immediately.



Note:

AdBlue® freezes at a temperature of approximately -11 °C. The bus is equipped with an AdBlue® preheating system as standard. Winter operation is thus ensured, even at temperatures below -11 °C.

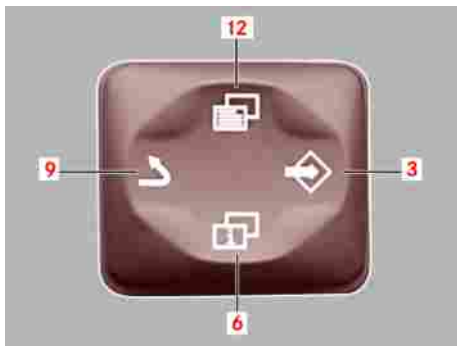

M54_30-0105-71

- ▶ Press button (12) of the control rocker switch repeatedly until the AdBlue® display appears on the display screen.



M47_00-0073-71

- ▶ The AdBlue® level is displayed as a percentage.



M47_00-0068-71

- ▶ If the AdBlue® service product reaches the reserve level, the message “RES” appears on the display screen to remind the driver that an AdBlue® top-up is due. “RES” and “%” flash alternately.



Note:

The driver has previously received a yellow alert.

Filling with AdBlue®



M47_00-0069-71

- ▶ If the AdBlue® supply tank runs empty, the driver is notified by the level gauge indication "0 %" on the display screen. In addition, the exhaust gas cleaning system (SCR system) malfunction display in the indicator lamp panel begins to flash. In this event, it is necessary to top up the AdBlue® level immediately.



Note:

The driver has previously received a yellow alert.



Note:

In the event of a malfunction in the BlueTec® exhaust gas cleaning system, the exhaust gas cleaning system (SCR system) malfunction display in the indicator lamp panel lights up.



M47_00-0071-71

- ▶ If no signal from the AdBlue® supply tank is received, "---%" will appear on the display screen.

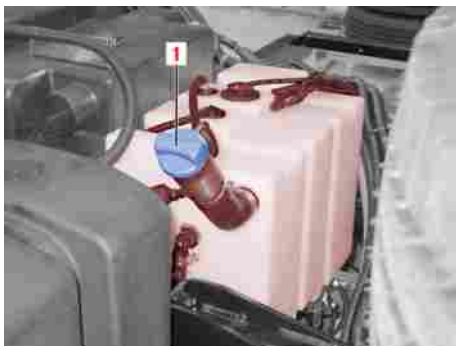

M47_00-0070-71

- ▶ Add AdBlue® to supply tank (1).

**Note:**

The AdBlue® supply tank is located either on the right-hand side to the front of the front axle, in the centre to the front of the front axle, or above the trailing axle (in the centre above the transmission).

Diesel particulate filter

A yellow indicator lamp  in the instrument cluster warns that the diesel particulate filter is nearing a critical load state and indicates a malfunction.

The on-board computer gives prompt warnings of emission-relevant malfunctions or incorrect operation.

If these messages are disregarded, there is a risk of engine power output being reduced or a need to exchange the diesel particulate filter prematurely.

**Note:**

As long as no flashing yellow or constant red malfunction alert appears, it can also be sufficient to alter the load profile (e.g. take the bus for a drive on the motorway) in order to ensure that automatic regeneration of the diesel particulate filter finishes successfully.

**Note:**

In the event of a malfunction in the BlueTec® exhaust gas aftertreatment system, have the system checked and repaired at a qualified specialist workshop.

**Danger.**

Exhaust fumes are produced during the manual regeneration process (parked regeneration). If you were to inhale these exhaust fumes, you could suffer harmful effects such as poisoning. For this reason, the bus should always be parked outdoors. If, however, the bus is parked in an enclosed room, adequate ventilation must be ensured.

**Danger.**

Very hot exhaust fumes are expelled from the exhaust tail pipe during the manual regeneration process (parked regeneration). Keep well clear of the exhaust tail pipe. Otherwise, you could be burned by

Diesel particulate filter

the fumes. The use of an extraction system should be avoided because this will generally not have been designed to withstand the exhaust temperature levels that arise.



Danger.

Make sure that no highly flammable materials, e.g. dry grass or fuels, come into contact with the exhaust system during the manual regeneration process (parked regeneration). Do not leave the bus parked up at a filling station, on dry grass or on harvested crop fields. The hot exhaust system could otherwise cause the highly flammable material to ignite and set the bus on fire.



Danger.

The exhaust tail pipe has been designed in such a way that the exhaust gas temperature falls relatively quickly with increasing distance. For this reason, no other exhaust tail pipe may be fitted.

If the diesel particulate filter load state becomes critical, a yellow indicator lamp  lights up in the instrument cluster. The on-board computer prompts you to start manual regeneration. The manual regeneration process lasts approximately 30 to no more than 60 minutes.



Note:

If this message is disregarded, there is a risk of engine power output being reduced and a need to exchange the diesel particulate filter prematurely.



Danger.

Exposure to diesel soot and soot particles through contact or inhalation is harmful to health and can lead to death. If you need to exchange a diesel particulate filter yourself due to technical problems, be sure to observe the information and instructions in the workshop information and all applicable occupational safety and accident-prevention regulations. Wear gloves and a dust mask. Seal and pack a particle-laden diesel particulate filter in

the original packaging immediately after removal. A particle-laden diesel particulate filter must be labelled and must not under any circumstances be left uncovered indoors.

▷ For instructions on how to initiate diesel particulate filter regeneration manually (parked regeneration), refer to the “Starting regeneration of the diesel particulate filter manually” section.

Diesel particulate filter regeneration

Diesel particulate filter regeneration

Functions:

- Automatic regeneration of the diesel particulate filter
- Inhibiting automatic regeneration of the diesel particulate filter

Automatic regeneration of the diesel particulate filter

Whenever the green “Particulate filter” indicator lamp  in the instrument cluster lights up, this means that the diesel particulate filter is undergoing automatic regeneration.

 Note:

Automatic regeneration does not start unless all necessary operating conditions have been fulfilled, e.g. engine oil or exhaust gas temperatures sufficiently high and engine running.

 Note:

If regeneration is in progress and one of the operating conditions is subsequently no longer fulfilled, the green indicator lamp  goes out prematurely and regeneration is aborted.

 Note:

It restarts automatically when all necessary operating conditions are fulfilled again. Interrupting the drive while the green “Particulate filter” indicator lamp  is lit will prolong the duration of regeneration.

 Note:

If the elevated exhaust gas temperatures associated with regeneration may present a danger, e.g. where the heat produced may jeopardise safety, it is possible to inhibit the automatic regeneration process.

Inhibiting automatic regeneration of the diesel particulate filter

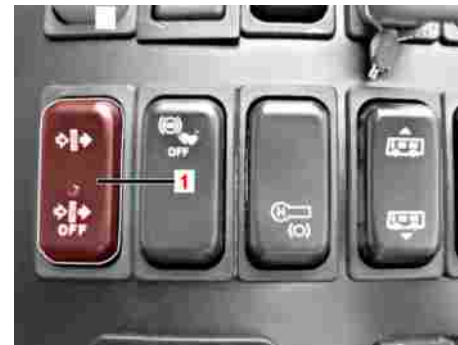

M54.25-0136-71

If the elevated exhaust gas temperatures associated with regeneration may present a danger, e.g. where the heat produced may jeopardise safety, it is possible to inhibit the regeneration process. Neither automatic nor manual regeneration can then be initiated and regeneration is stopped if it is already in progress.

Press the lower section of pushbutton (1).

Starting regeneration of the diesel particulate filter manually



Note:

The LED in the pushbutton has no function. With the regeneration inhibitor activated, the yellow “Particulate filter” indicator lamp in the instrument cluster lights up continuously.



Caution:

Leave the regeneration inhibitor activated only for as long as the danger exists. Whenever you activate the regeneration inhibitor, regeneration will continue to be inhibited even after the next engine start.



Note:

There would otherwise be a risk of rapid loading of the diesel particulate filter.

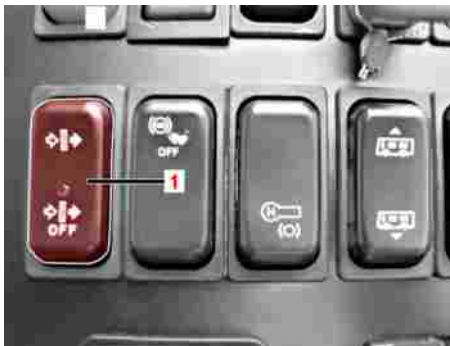

M54.25-0136-71

To deactivate, press the lower section of inhibit pushbutton (1) again.



Note:

The yellow “Particulate filter” indicator lamp in the instrument cluster goes out.

Starting regeneration of the diesel particulate filter manually

- ▶ Pull over safely with regard for other traffic and leave the engine running. Maintain a minimum distance of 2 metres from other vehicles, objects and all flammable materials.



Note:

If the diesel particulate filter load state becomes critical, an indicator lamp  lights up in the instrument cluster. The on-board computer displays a yellow event window prompting you to start manual regeneration. The manual regeneration process lasts approximately 30 to no more than 60 minutes.

- ▶ Apply the parking brake.
- ▶ Shift the transmission to neutral N.
- ▶ Take your foot off the accelerator pedal.

Starting regeneration of the diesel particulate filter manually

- ▶ If active, deactivate the regeneration inhibitor.

**Note:**

refer to “Inhibiting automatic regeneration of the diesel particulate filter”.

- ▶ Press and hold the upper section of “Manual regeneration” pushbutton (1) for approximately 3 seconds.

**Note:**

Manual regeneration cannot be started unless the engine oil and exhaust gas temperatures are sufficiently high, the AdBlue® is not frozen and the system is functioning normally.

The green “Particulate filter” indicator lamp  in the instrument cluster comes on and engine speed is increased.

When regeneration has finished, the green “Particulate filter” indicator lamp  in the instrument cluster goes out and engine speed drops to idling speed.

**Note:**

Regeneration will be aborted automatically if you deselect transmission neutral position, release the parking brake or activate the regeneration inhibitor by pressing the lower section of the “Regeneration inhibitor” pushbutton.

**Note:**

Engine speed drops to idling speed if the process is aborted.

**Note:**

Regeneration cannot be started unless all necessary operating conditions have been fulfilled, e.g. engine oil or exhaust gas temperatures sufficiently high. If the on-board computer prompts manual regeneration at low outside temperatures, start the regeneration process before the vehicle is parked. If you were to park the vehicle without initiating regeneration, you would not be able to start the regeneration process manually until after a subsequent engine warm-up phase. If

you were to park the vehicle without initiating regeneration and the AdBlue® were frozen, you would not be able to start the regeneration process manually until after a thawing period of up to 60 minutes.

Operating/malfunction displays: fuel system

Operating/malfunction displays: fuel system

Fuel reserve



Fuel level below approximately 14% of tank capacity

AdBlue® level



If the AdBlue® service product reaches the reserve level, this icon appears on the display screen in conjunction with a yellow alert to remind the driver that an AdBlue® top-up is due.



Note:

The AdBlue® level can be called up using the OBD (on-board diagnostics).

Exhaust gas cleaning malfunction

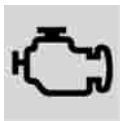

The malfunction indicator lamp on the indicator lamp panel lights up in the event of a malfunction in the exhaust gas cleaning system (SCR system).



Danger.

Have the malfunction rectified by an OMNIplus Service Partner immediately.

Fault in the exhaust gas cleaning system



The malfunction indicator lamp on the indicator lamp panel flashes in the event of a fault in the exhaust gas cleaning system (display if permissible NOx values exceeded, if NOx sensor fitted) or if the AdBlue® supply tank runs empty. If the malfunction alert was triggered by the AdBlue® supply tank running empty, it is necessary to top up the AdBlue® level immediately. If the AdBlue® supply tank has run empty, the driver must have actively acknowledged the AdBlue® level operating display at some time previously.

Brake system safety precautions

Brake system safety precautions



Caution:

The braking characteristics of the bus may change if a yellow warning level malfunction in the brake system appears on the instrument cluster display screen. Adopt a particularly cautious driving style. Have the malfunction rectified as soon as possible by an OMNIplus Service Partner.



Danger.

The braking characteristics of the bus have changed if a red warning level malfunction in the brake system is displayed. Pedal travel may increase under braking. ABS has been disabled. Stop the bus immediately and disable it (traffic conditions permitting). Have the malfunction rectified by an OMNIplus Service Partner immediately.



Danger.

Have NOx faults rectified immediately by an OMNIplus Service Partner.

Engine torque reduction (applicable only to buses with NOx sensor)



M54_30-0143-71

Engine torque is reduced to approximately 60 % in the event of a NOx fault (display if permissible NOx values exceeded). In this situation, a fault is also present in the exhaust gas cleaning system, i.e. the malfunction indicator lamp flashes and the red status indicat-

or lights up. If the fault was caused by the AdBlue® supply tank running empty, the AdBlue® level operating display is also displayed. The AdBlue® supply tank must be filled immediately.



Danger.

Have NOx faults rectified immediately by an OMNIplus Service Partner.

Braking and stopping

Braking and stopping

- ▶ Whenever the bus is driven for long distances downhill, you should make use of the braking effect of the engine by shifting into a lower gear. Use the continuous brakes to relieve the load on the service brake.



Note:

Except for emergencies, the service brake does not usually need to be applied sharply.



Danger.

Always apply the parking brake before you disembark. On uphill and downhill gradients, you must also chock the wheels and turn the steering towards the kerb.

- ▶ Switch off the engine using the ignition starter switch

Brakes with anti-locking protection

- ▶ In a hazardous situation, the brake pedal should be depressed fully. This ensures that all wheels are braked with ABS assistance and optimum deceleration is achieved.
- ▶ On a slippery road surface, you should also declutch so that the braking effect of the engine cannot affect the ABS control intervention.



Note:

The retarder is deactivated automatically for the duration of an ABS control intervention.



Danger.

The anti-locking protection of ABS does not relieve the driver of the responsibility for adopting a driving style which takes traffic and road conditions into account. While the directional stability and steerability of the bus are improved under braking, ABS is not able to avert the consequences of driving at an unsafe dis-

tance from the vehicle in front or driving too fast through corners.



Danger.

If the bus is towing a trailer that does not have ABS, this trailer could be overbraked if the brakes were applied with maximum force. In this case, the driver must keep an eye on the trailer in the rear-view mirror. The bus equipped with ABS remains steerable, thereby enabling the driver to keep the entire vehicle combination stable.

Applying/releasing the parking brake

Applying/releasing the parking brake



Note:

Precondition: operating pressure at least 5.8 bar to 6.4 bar



Danger.

Do not apply the parking brake unless the bus is stationary. Always apply the parking brake before you leave the driver's area. On steep uphill and downhill gradients, you should also chock the wheels and turn the steering towards the kerb.

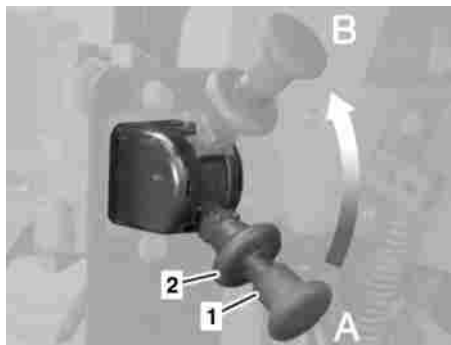

M42_20-0003-01

- Move parking brake lever (1) down into position A and engage it.



Danger.

Check the hand lever for full engagement. To do so, attempt to press the hand lever in direction "B" without pulling release ring (2) out of the detent position. The lever must not move.

The parking brake is applied (air venting noise can heard when it is operated).

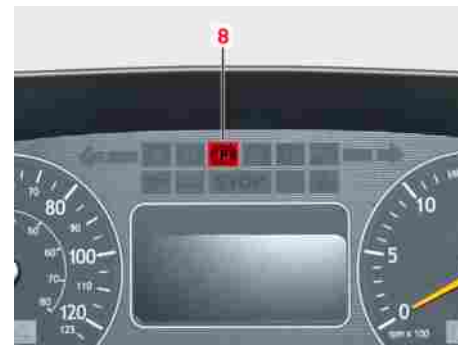

M54.00-1862-71

- Indicator lamp (8) lights up.
 - Raise locking ring (2) and pull parking brake lever (1) upwards into position "B".
- The parking brake is released (air charging noise can be heard).

Emergency braking in the event of failure of both brake circuits



M54.00-1862-71

Indicator lamp (8) goes out.



Caution:

To guarantee a faultless release of the parking brake, the supply pressure must be at least 6.4 bar. If parking brake indicator lamp (8) does not go out even if there is sufficient supply pressure available, there is a defect in the brake spring cylinder circuit or the emergency release circuit. Have the brake system inspected by an OMNIplus Service Partner.



Note:

A continuous warning tone sounds if the ignition starter switch is switched to OFF while the parking brake is released.

Emergency braking in the event of failure of both brake circuits



Danger.

A failure in brake circuits 1 and 2 will jeopardise the operating safety and road-worthiness of the bus. Stop the vehicle immediately (traffic conditions permitting). Have the brake system checked by an OMNIplus Service Partner immediately.



Note:

In the event of a failure in brake circuits 1 and 2, it is possible to initiate emergency braking using the parking brake lever.

Deactivating the Electronic Stability Program (ESP)

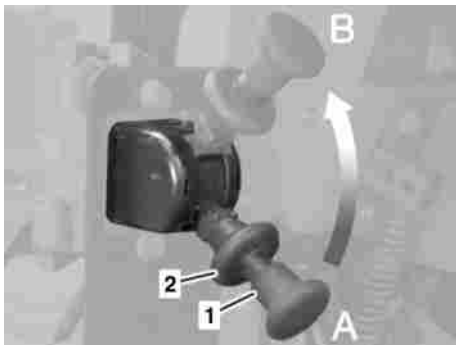

M42_20-0003-01

- Pull the hand lever gradually towards “A” and hold it in the desired position to prevent it from automatically returning to released position “B”.



Danger.

If it is necessary to perform emergency braking using the parking brake, do not allow the parking brake lever to engage in the parking position. Keep release ring (1.1) in the applied position.

The bus is braked at the rear wheels only.



Note:

Parking brake lever (1) can be moved rearwards to any position to enable the driver to prevent the rear wheels from locking and to moderate the braking effect.



Danger.

Risk of accident. Applying the parking brake deactivates the anti-lock braking system (ABS). You should exercise even more caution when driving on slippery roads because there would be a risk of rear wheels locking.

Deactivating the Electronic Stability Program (ESP)



Note:

It is recommended that ESP be deactivated if traction problems are experienced when driving with anti-skid chains fitted or on loose surfaces (e.g. sand and gravel).



Danger.

Risk of accident. The bus may skid out of control if ESP has been deactivated and the drive wheels start to spin.

Brake system (BS)



M54.25-0137-71

- ▶ Press ESP OFF pushbutton (1).



The control functions of the dynamic drive control (FDR) and acceleration skid control (ASR) are disabled. The yellow ESP indicator lamp lights up.



Note:

Pressing the pushbutton again or switching the ignition starter switch to OFF and back to ON reactivates ESP.

Brake system (BS)



Note:

The electronic brake system (BS) manages the braking of the bus. The brake system (BS) combines the following integral functions: anti-lock braking system (ABS), acceleration skid control (ASR), Electronic Stability Program (ESP), drive-off lock and bus stop brake. This combination is designed to provide a faster braking effect at the wheel brakes, and optimum distribution of braking force to individual axles. It is possible to have the continuous brakes (engine brakes/rearder) activated automatically whenever the brake pedal is depressed (continuous brake integration).



Note:

ASR, ESP, drive-off lock, bus stop brake and continuous brake integration are optional functions.

Anti-lock braking system (ABS)

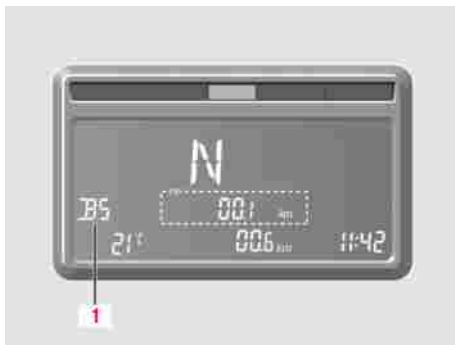

M54_30-0120-71

- ▶ **Malfunction display:** A malfunction in the electronic brake system is indicated on the display screen by “BS” (1).



Danger.

The driving and braking characteristics of the bus may change. In the event of a yellow alert, adopt a cautious driving style. Have the malfunction rectified by an OMNIplus Service Partner. In the event of a red alert, stop the bus at the earliest opportunity (traffic conditions permitting) and notify an OMNIplus Service Partner.



Note:

The status lamp and, if applicable, the “ABS” indicator lamp in the indicator lamp panel light up red or yellow, depending on the fault severity.

- ▶ Each wheel is equipped with sensors that continuously record the rate of brake pad wear.



An overly worn brake pad is indicated on the display screen (refer to the “Operation” section).



Danger.

The driving and braking characteristics of the bus may change. Adopt a cautious driving style. Have the malfunction rectified by an OMNIplus Service Partner.

Anti-lock braking system (ABS)



Note:

The anti-lock braking system (ABS) prevents the wheels from locking above a speed equivalent to walking pace, regardless of the road conditions.



Danger.

In the event of danger, the brake pedal should therefore be fully depressed. This ensures that all wheels are braked with ABS assistance and optimum deceleration is achieved. On a slippery road surface, you should also declutch so that the braking effect of the engine cannot affect the ABS control intervention.



Danger.

The anti-locking protection of ABS does not relieve the driver of the responsibility for adopting a driving style which takes traffic and road conditions into account. While the directional stability and steerability of the bus are improved un-

Anti-lock braking system (ABS)

der braking, ABS is not able to avert the consequences of driving at an unsafe distance from the vehicle in front or driving too fast through corners.

- ▶ Function check: Switch the ignition starter switch to ON.



M54.00-1864-71

ABS indication display (3) lights up on the display screen for approximately 2 seconds.



Danger.

The indicator must light up and go out after approximately 2 seconds or immediately as soon as the bus pulls away. If the indicator does not go out, or if it lights up while the bus is in motion, neither ABS nor ASR is guaranteed to function correctly. Adopt a cautious driving style and have the malfunction rectified by an OMNIplus Service Partner.



M54.00-1865-71

- ▶ If the continuous brakes are active and one or both of the wheels on the rear axle threaten to lock, the continuous brakes will be deactivated automatically by ABS. However, “Continuous brake” indicator lamp (10) will remain lit if the continuous brake switch remains pressed in.

Acceleration skid control (ASR) (option)

Acceleration skid control (ASR) (option)

i **Note:**

Acceleration skid control (ASR) prevents the drive wheels from spinning when the bus pulls away or accelerates, regardless of the road conditions.

! **Danger.**

Risk of accident. ASR does not relieve the driver of the responsibility for adopting a driving style which takes traffic and road conditions into account. The bus could skid if ASR has been switched off and the drive wheels start to spin.



M54.00-1861-71

- ▶ Indicator lamp check: Switch the ignition starter switch to ON.
“ASR” indicator lamp (9) lights up and must go out after approximately 2 seconds.
- ▶ ASR is activated automatically if the drive wheels on one or both sides start to spin.
“ASR” indicator lamp (9) lights up.

- ▶ If the drive wheels on one side start to spin, they will be braked automatically.
- ▶ If the drive wheels on both sides start to spin, engine power output will be reduced automatically.

i **Note:**

Drive/brake cruise control cannot be activated (or switched on). If cruise control was active at the time of the ASR intervention, it will be deactivated automatically and then reactivated as soon as the ASR intervention has taken place.

- ▶ ASR can be switched off manually: Press the “ASR” pushbutton.

! **Danger.**

The bus could skid if ASR has been switched off and the drive wheels start to spin.

Bus stop brake (option)



“ASR” indicator lamp (9) flashes.



M54.00-1861-71

- ▶ Press the “ASR” pushbutton again.

Driving with “ASR”, “ASR” indicator lamp (9) must go out.



Note:

Acceleration skid control is reactivated automatically if the engine is switched off and on again.

Bus stop brake (option)

- ▶ The bus stop brake is activated when the relevant switch on the instrument panel is pressed.



Note:

The bus stop brake requires less compressed air than the parking brake. At bus stops, therefore, you should give priority to the use of the bus stop brake where possible.



Caution:

Do not operate unless the bus is stationary.

Bus stop brake with drive-off lock (option)



Danger.

Risk of accident. Always apply the parking brake correctly before you leave the driver's area. To park the bus, always apply the parking brake. If necessary (e.g. on steep uphill or downhill gradients), chock the wheels as an additional measure to prevent the bus from rolling away and turn the steering towards the kerb.



M54.00-1867-71

- Response on the bus when the bus stop brake is active:

Indicator lamp (14) lights up in the instrument display panel.

All wheel brakes are automatically braked with 2.0 bar compressed air.

Bus stop brake with drive-off lock (option)



Danger.

If the drive-off lock is not used as intended, the vehicle could roll away. This could result in an accident with serious or fatal injuries. For this reason, always apply the parking brake before you start/stop the engine or leave the driver's area. Do not under any circumstances use the drive-off lock as a parking brake or hillholder. Apply the parking brake whenever you come to a stop on a steep uphill or downhill gradient of more than 15 % or pull into a bus stop on a steep uphill or downhill gradient of more than 15 %.

Bus stop brake with drive-off lock (option)



Note:

The only difference between the “bus stop brake with drive-off lock” and the standalone “bus stop brake” is in the function range that each system has to offer. With the switch pressed in, the “bus stop brake with drive-off lock” system not only applies all wheel brakes but also inhibits its idling speed increases associated with accelerator pedal operation.



Note:

The “bus stop brake with drive-off lock” may (depending on the body manufacturer) also be controlled by other components (e.g. door or luggage compartment flaps).



Note:

Buses with a drive-off lock have an emergency release switch.



M54.00-1867-71

- ▶ The automatic bus stop brake is not deactivated until all activation conditions are no longer in effect (e.g. passenger doors no longer open) and the accelerator pedal is subsequently depressed.

Indicator lamp (14) must go out.

- ▶ “Emergency off” switch in conjunction with “automatic bus stop brake”.
- ▶ In emergencies (e.g. technical defect), it is possible to deactivate the automatic bus stop brake using the emergency release switch. This makes it possible to continue

the journey but with certain function limitations.



Danger.

Make sure that the door and all luggage compartment flaps are securely closed before you operate the emergency switch. Adopt a cautious driving style, and always apply the parking brake when the bus is stationary because it is no longer possible to activate the bus stop brake using the switch on the instrument panel. Have the fault rectified by an OMNIplus Service Partner as soon as possible.



Operation: Raise the switch cover and pull up the yellow pin. To reset the switch: Press the yellow pin in and close the cover.

Brake system supply pressures



Note:

To ensure maximum operating safety and reliability, the supply pressures in the individual compressed-air circuits for the brake system (10 bar) and auxiliary consumers (8.5 bar) must be charged to an appropriate level. The auxiliary consumers circuit will not be charged until brake circuits 1 and 2 have been charged. The supply pressure required for the service brake is 10 bar.



M54.00-1863-71

- ▶ The brake circuit with the lower supply pressure is automatically indicated by indicator lamp (1) or (2). Display (3) is the pressure reading for this brake circuit.



M54.00-1866-71

If the supply pressure in brake circuit 1 or 2 drops below 6.8 bar or if the pressure in the parking brake circuit drops below 5.5 bar, a red alert appears and the STOP lamp and brake failure indicator lamp (5) light up.



Danger.

Stop the vehicle immediately (traffic conditions permitting). Have the brake system inspected by an OMNIplus Service Partner.

Continuous brakes operating information



Danger.

There is a sensor fault if no warning is displayed on the display screen and there is no pressure reading on the pressure gauge. Stop the vehicle immediately (traffic conditions permitting). Have the brake system inspected by an OMNIplus Service Partner.

- ▶ In the event of high compressed-air consumption (e.g. raising/lowering system in effect and bus manoeuvring), stop driving until the indicator lamp has gone out. The malfunction warning is not cleared until the pressure has risen back above 7.2 bar.
- ▶ Indicator lamp (5) lights up if the supply pressure in the auxiliary consumers circuit (option) drops below 5.5 bar.



Danger.

Malfunctions may occur in the air suspension system, door system or clutch mechanism. Adopt a cautious driving style. Have the compressed-air system checked immediately by an OMNIplus Service Partner.



Continuous brakes operating information



Note:

The bus is equipped with engine brakes (wear-free auxiliary brakes) and a retarder (option). The continuous brakes are activated on demand using the “combination switch for continuous brakes and cruise control” (refer to the “Driver's area controls” section). It is also possible to have the continuous brakes activated automatically whenever the brake pedal is depressed (continuous brake integration) (option).

Continuous brakes operating information

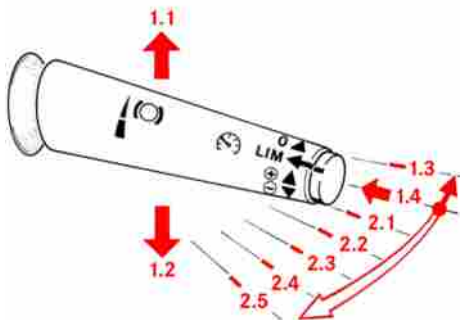

M54_00-0082-01

- ▶ The continuous brakes are activated with the combination switch in position 2.1-2.2 (2.1-2.5) (depending on the version).



M54.00-1865-71

- ▶ “Continuous brake” indicator lamp (10) lights up when the continuous brakes are activated.



Caution:

Do not activate the retarder if the “Continuous brake” indicator lamp lights up with the lever in position “0”. Have the malfunction checked by an OMNIplus Service Partner.



This icon may also appear.

- ▶ Two different engine braking stages are available (exhaust flap and constantly open throttle). The effect of the engine brake is dependent on the engine speed (high engine speed = high engine braking output). The engine brake is effective only at engine speeds above 900 rpm and is available up to an engine speed of approximately 2,300 rpm. Keep an eye on the optimum operating range for the engine brakes (yellow zone) in the rev counter.



Note:

How the engine braking stages are controlled (from lever position 1) is determined by the drive control system under consideration of various factors.

Continuous brakes operating information



M54.00-1865-71

- ▶ Retarder (option) with manual transmission: 4 braking stages are available (from switch position 2.2).



Caution:

Only ever move the combination switch through one stage at a time when attempting to achieve the necessary braking torque (do not jerk it directly to the required position). Except in an emergency, it is prohibited to force the combination switch directly to the required position in one action. However, it is acceptable to skip several stages at once if you are reducing the braking torque.



Note:

Preconditions for retarder operation: Accelerator pedal fully released, bus travelling faster than 15 km/h.



Note:

For the optimum braking torque to be achieved, the engine should be turning within its upper speed range so that the coolant does not overheat.

- ▶ Retarder protection function: The braking effect of the retarder is automatically reduced in line with a specified coolant temperature characteristic curve and is reduced to zero at a coolant temperature of over 115 °C.



The “Retarder temperature” display appears on the display screen and

“Continuous brake” indicator lamp (10) flashes.



Danger.

The retarder's braking effect is reduced or may even be deactivated. Reduce bus speed, shift down and keep the speed of the bus constant by making use of the braking effect of the engine.

- ▶ The retarder is deactivated automatically in response to accelerator pedal operation or an ABS control intervention.



Danger.

Retarder braking torque is reduced to zero.



Danger.

If an ABS fault alert is displayed, the retarder will not be deactivated in the event of an ABS control intervention - risk of skidding.

Continuous brakes operating information

- ▶ The “Retarder cannot be deactivated” display appears on the display screen if the retarder can no longer be deactivated.



Danger.

Risk of accident. Adopt a particularly cautious driving style. Do not continue to use the retarder. Have the malfunction rectified by an OMNIplus Service Partner.

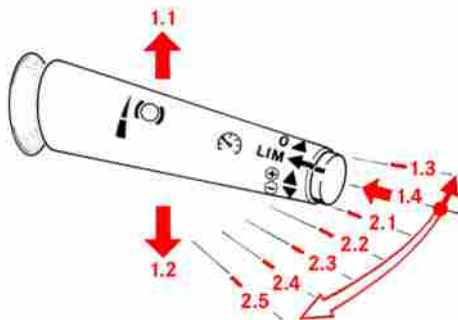

M54_00-0082-01

- ▶ Retarder (option) with automatic transmission: 3 braking stages are available (from switch position 2.3).



Note:

Preconditions for retarder operation: Accelerator pedal fully released, forward drive range (1-D) selected, bus travelling faster than 3 km/h.



Note:

Whenever the retarder is active, the transmission is prevented from shifting into the next gear up (upshift inhibitor).



Danger.

If the accelerator pedal is depressed while the continuous brakes are active, the continuous brakes will be deactivated and the upshift inhibitor will be cancelled.



The braking effect of the retarder is automatically reduced in line with a specified oil temperature characteristic curve.

Displaying the engine operating hours



Danger.

The braking output is reduced.

Displaying the engine operating hours

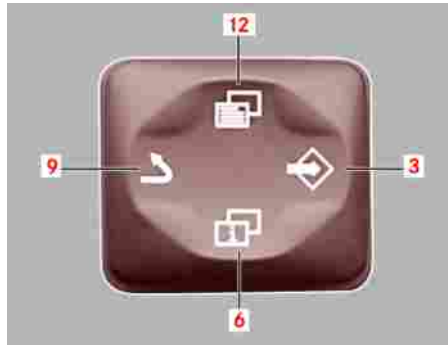

M54_30-0105-71

- ▶ Press button (12) of the control rocker switch repeatedly until the “OEL” (OIL) oil level menu appears on the display screen.



Note:

Applies only to buses with electronic oil level detection (option). In vehicles without electronic oil level detection, the operating hours are called up directly by means of button (12).

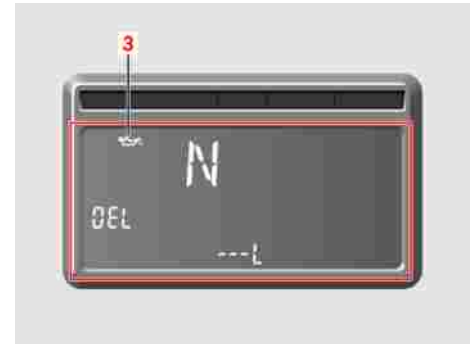

M54_30-0170-71

- ▶ Oil level menu with oil level symbol (3).

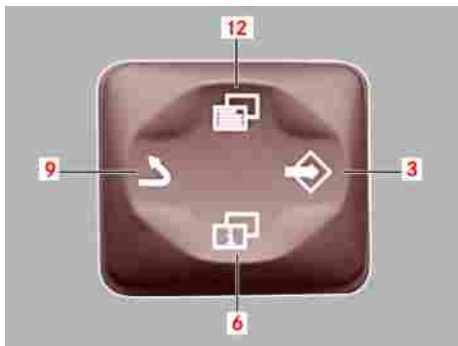

M54_30-0105-71

- ▶ Press button (6) of the control rocker switch

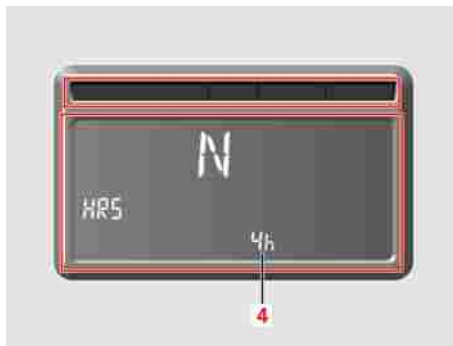

M54_30-0171-71

- ▶ Engine operating hours (4) are displayed.

Care and cleaning



Note:

Observe the laws and regulations in all countries concerned.



Danger.

Risk of injury. Whenever work is carried out on the bus, all applicable safety regulations must be observed (e.g. operating instructions, environmental laws and regulations, occupational safety and accident prevention regulations, etc.).



Danger.

Risk of poisoning. Observe the instructions for use of the care and cleaning products.

Care and cleaning



Danger.

Risk of poisoning. Always keep care and cleaning products sealed and out of the reach of children.



Danger.

Risk of poisoning. Diesel, regular and premium-grade fuels are harmful to health. They should not be used as a cleaning product.



Danger.

Risk of fire. Diesel, regular and premium-grade fuels are highly flammable. They should not be used as a cleaning product.



Danger.

Do not use round-spray jets to clean tyres or suspension air bags. The pulsating jet of water could cause concealed damage to the tyre substructure or suspension air bags. This damage would not become

apparent until much later and could cause the tyre or suspension air bag to burst. You could then lose control of your bus and cause an accident, which could result in injury to yourself and others.



Caution:

Do not work with high-pressure cleaners or steam cleaners in the region of axle seals (e.g. hubs, drive flange) and axle breathers. In automatic vehicle washes, make sure that these areas will not be severely subjected to jets of water.



Caution:

We recommend that only tested and approved care products should be used. Information about acceptable care products can be obtained from your OMNIplus Service Partner.



Caution:

For cleaning work in the engine compartment, the use of cleaning agents containing acetone or chloroethylene is prohibited.



Caution:

If you are using a steam cleaner to perform cleaning work in the engine compartment, do not aim the jet directly at belt tensioners or idler pulleys.



Caution:

Stone chips and impurities, especially insect remains, bird droppings, tree resins, oils and greases, fuels and tar stains, should be remedied immediately with the use of approved care products.



Caution:

The bus must be cleaned more frequently in winter to remove salt residues from road gritting.



Environmental protection

Dispose of empty containers, cleaning cloths and polishing wads in an environmentally responsible manner.

Instrument display panel	60
Warning and indicator lamps	64
On-board computer	66
On-board computer control rocker switch	70
DTCO tachograph	72
MTCO tachograph	74
Vehicle tool kit and emergency equipment (option)	76
Auxiliary heating preset timer (option)	78

Instrument display panel

Instrument display panel



Caution:

A warning buzzer sounds if the maximum permissible engine speed is exceeded. The engine quietens after the maximum permissible engine speed has been exceeded. For this reason, you should not judge how to drive or change gear by ear but by the display in rev counter (5). Avoid overrevving in the red danger zone. There is a risk of engine damage.

Instrument display panel

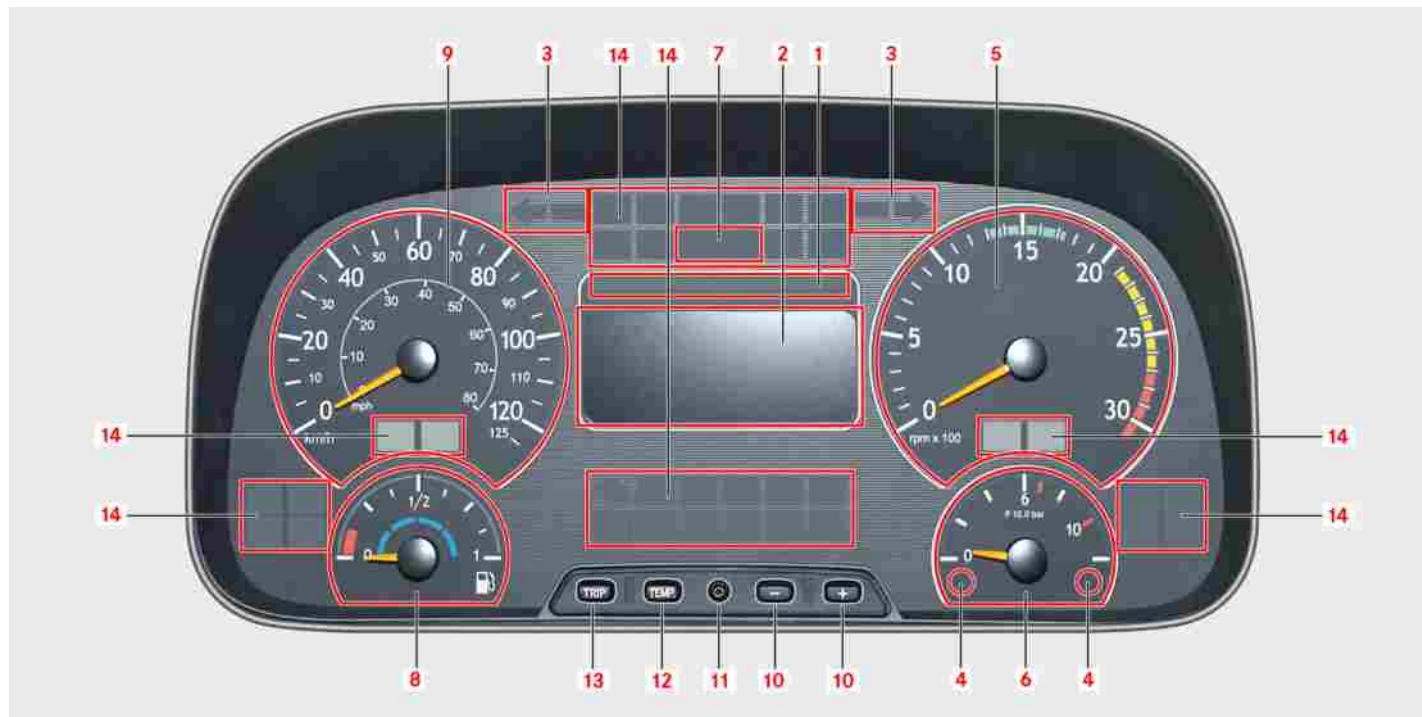

No.	Description	Page
1	Red/yellow malfunction lamp	
2	Display screen	
3	Turn signals/hazard warning lamps	
4	Brake circuit 1 and 2 supply pressure	
5	Engine speed display	
6	Supply pressure gauge for brake circuit 1 or 2	
7	Red STOP warning lamp	
8	Fuel level and Ad-Blue® gauge	
9	Speedometer	
10	Instrument lighting dimmer	
11	Reset button	

No.	Description	Page
12	Outside temperature/coolant temperature toggle button	
13	Reset trip meter to "0"	
14	Indicator lamp panel	

Warning and indicator lamps

No.	Description	Page
1	Main-beam head-lamps	
2	Brake failure	
3	Parking brake	
4	Engine protection	
5	ABS	
6	Trailer ABS (option)	
7	Stop request indication display	
8	Centring of the auxiliary steering (3-axle buses only)	
9	DPF cleaning (diesel particulate filter)	
10	Hazard warning lamps	

No.	Description	Page
11	Emission-relevant fault malfunction display (MIL)	
12	ESP	
13	Fire in engine compartment (option)	
14	Flame-start system (option)	
15	V-belt break (option)	
16	Hillholder	
17	Alternator 1	
18	DPF cleaning (diesel particulate filter)	
19	Automatic engine start-stop (option)	
20	Pull-away aid (option)	

No.	Description	Page
21	DPF status (diesel particulate filter)	
22	Bus stop brake	
23	ESP	
24	Distance warning	
25	Continuous brake	
26	Continuous brake malfunction	
27	Not assigned	
28	Diesel particulate filter (DPF) manual regeneration	
29	Additional indicator lamps (option)	

On-board computer

On-board computer



Note:

Using control rocker switch (2) and the button console on instrument panel (4), it is possible to call up and view displays and bus information on on-board computer display screen (1) and make changes to settings.



Danger.

Operating the on-board computer while the bus is in motion distracts your attention from the situation on the road. You could lose control of the bus and thereby cause an accident. For this reason, do not operate the on-board computer unless the bus is stationary and the parking brake is applied.



Note:

The on-board computer is active whenever the key is in the drive position in the ignition lock.

On-board computer



No.	Description	Page
1	Display screen	
2	On-board computer control rocker switch	70
4	Button console	

On-board computer control rocker switch

On-board computer control rocker switch

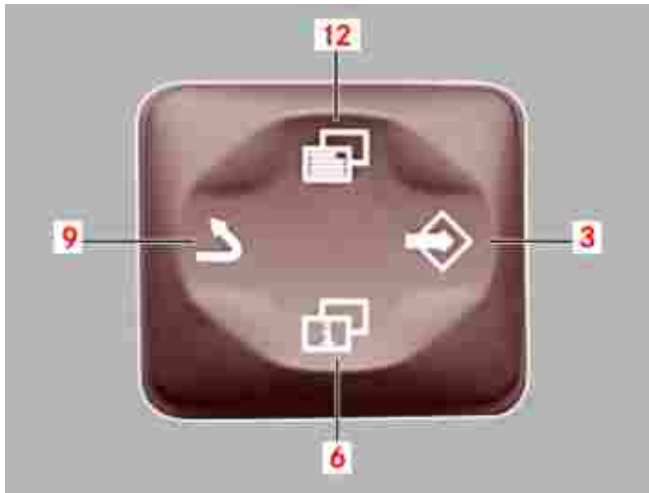



This control rocker switch is used to control the on-board computer, e.g. to call up displays or change settings.

- 12 Scroll
- 3 Adjustment
- 6 Info
- 9 Back

DTCO tachograph

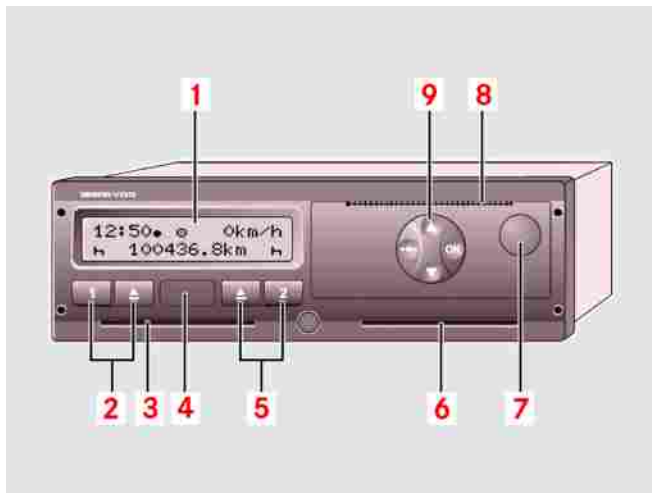
DTCO tachograph



- 1 Display screen: Screen displays vary according to the operating state of the bus.
 - ▷ Refer to “Display variants” in the manufacturer's operating instructions.
- 2 Key panel, driver 1
 -  **Note:**
Activity button, driver 1/card slot ejector button, driver 1
- 3 Card slot, driver 1: Driver 1, the current driver of the bus, inserts his driver card into card slot 1.
- 4 Download/calibration interface: There is an interface under the cover. This interface cannot be enabled without an inserted company card, control card or workshop card.
 - ▷ For details, refer to “Access rights for tachograph cards” in the manufacturer's operating instructions.
- 5 Key panel, driver 2
 -  **Note:**
Activity button, driver 2/card slot ejector button, driver 2
- 6 Card slot, driver 2: Driver 2, who is not currently driving the bus, inserts his driver card into card slot 2.
- 7 Printer drawer release button: This button is used to release the printer drawer, for example, for inserting a new roll of paper.
- 8 Tear-off edge
- 9 Menu buttons: Buttons for entering, displaying or printing data.
 - ▷ Refer to “Calling up menu functions” in the manufacturer's operating instructions.

MTCO tachograph

MTCO tachograph

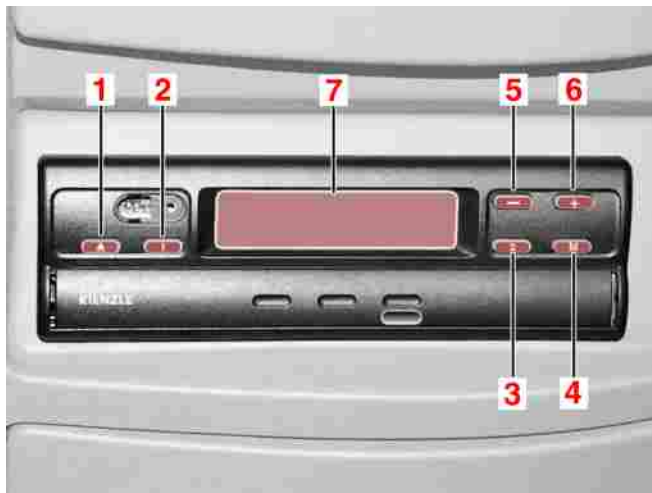

- 1 Button for opening the recording sheet tray: Driver 1 inserts his labelled recording sheet into the recording sheet tray and on top of the partition plate with the front side of the sheet facing upwards. Driver 2 inserts his labelled recording sheet into the recording sheet tray and underneath the partition plate with the front side of the sheet facing upwards. The recording sheets must be swapped over whenever the drivers change over.
- 2 Button for setting the required time group for driver 1: Press and hold the button until the required time group appears on the display screen.
- 3 Button for setting the required time group for driver 2: Press and hold the button until the required time group appears on the display screen.
- 4 Menu selection button: Various selection menus are available (refer to the manufacturer's operating instructions).
- 5 Button (-): : Move back within the menu
- 6 Button (+): : Move forward within the menu
- 7 Display screen (illuminated when ignition starter switch ON): The basic display (date, time and total distance) appears if there are no fault alerts. If the tachograph detects a fault, this is indicated on the display screen by a flashing 4-digit fault code. The function check in the tachograph lights up simultaneously. The faults below can be corrected by the operator:
 - ▷ If other fault codes are displayed: Visit your nearest OMNIplus Service Partner and have the fault rectified.

**Note:**

Always use the appropriate recording sheets (refer to the manufacturer's operating instructions).

**Note:**

8000 = driving without a recording sheet

**Note:**

8100 = recording sheet for driver 1 not inserted

Vehicle tool kit and emergency equipment (option)



Note:

8200 = recording sheet for driver 2 not inserted



Note:

8300 = the time on the recording sheet tray does not correspond to the time on the display screen (e.g. after a power interruption or time adjustment). Fault elimination: Remove both recording sheets, close the recording sheet tray minus the recording sheets, the time on the display screen and the recording sheet tray are (audibly) synchronised, open the recording sheet tray and reinsert the recording sheets.

Vehicle tool kit and emergency equipment (option)

Scope of tools and emergency equipment:

- Warning triangle
- Ramp
- Hydraulic jack 10 t maximum load with base board and pump lever (enclosed manufacturer's operating instructions must be strictly observed).
- Wheel chock
- WAF 32 socket spanner; spanner and extension
- Retainer for towing pin
- Tool box (with tyre inflation hose, torch, open-ended spanner set, screwdriver set, pliers)

Auxiliary heating preset timer (option)

Auxiliary heating preset timer
(option)

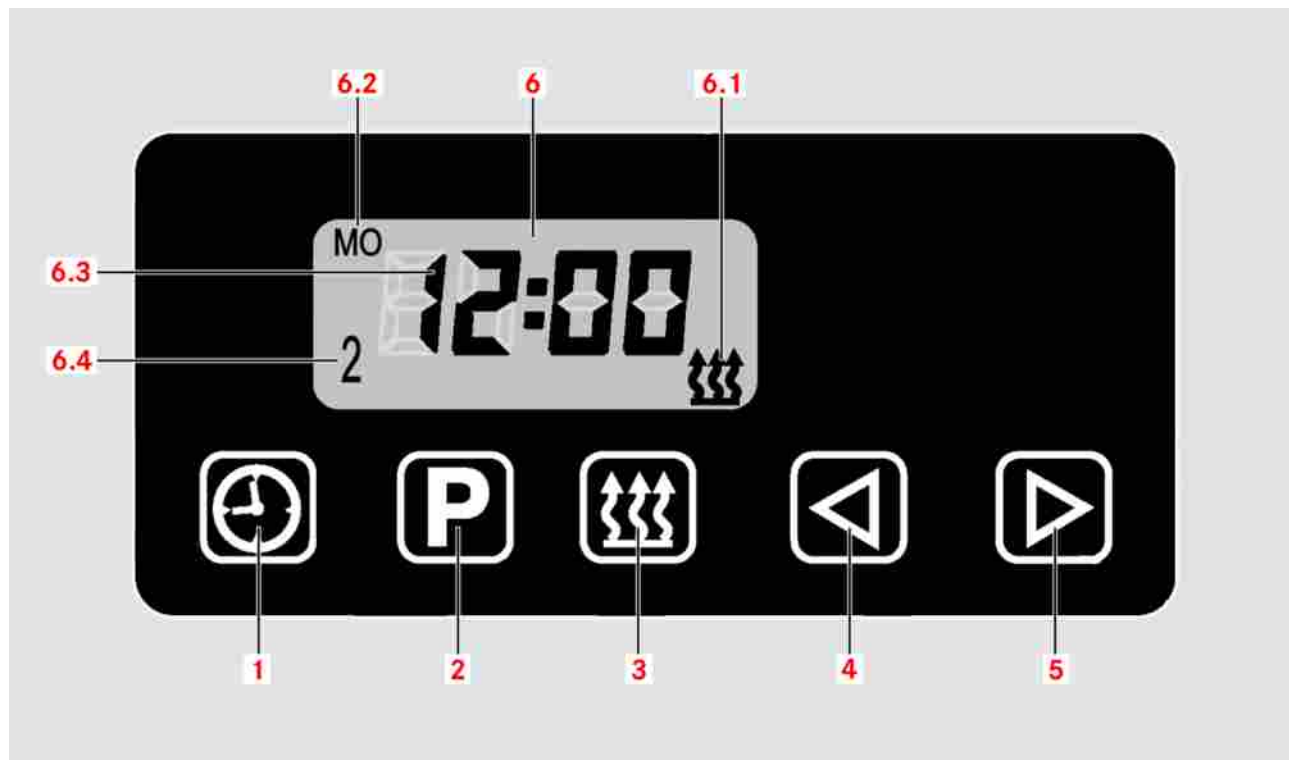

▷ For notes on safety and operation, refer to the “Heating/ventilation/air-conditioning” section

- 1 Time button
- 2 Program selection
- 3 Instant heating
- 4 Back
- 5 Forward
- 6 Screen display
- 6.1 Operating display
- 6.2 Weekday
- 6.3 Time display
- 6.4 Storage location

Rotary light switch	83
Combination switch for lights and wiper functions	83
Combination switch for continuous brakes and cruise control (option)	86
Adjustable steering column	90
Ignition starter switch	91
Parking brake valve	91
3-button automatic transmission gearshift unit	94
6-button automatic transmission gearshift unit (option)	96
Instrument display panel	97
Screen sequence at start-up	104
Display fields on the on-board computer display screen	105
Adjusting the instrument lighting	107
Malfunction displays: Description	108
Malfunction displays: red warning level - description	109
Malfunction displays on the on-board computer display screen with red status indicator - overview	112
Malfunction displays: yellow warning level - description	113

Table of contents

Malfunction displays on the on-board computer display screen with yellow status indicator - overview	116
Malfunction displays: STOP lamp - description	118
Malfunction displays on the on-board computer display screen with red STOP warning lamp - overview	120
Display screen symbols	121
Vehicle manoeuvrability with the air suspension depressurised	128
Air suspension versions	128
Lowering the bus on the boarding side (kneeling) (option)	129
Raising the bus body to driving ride height 2 (option)	130
General Information / Safety Information	131
Turning the steering wheel when the bus is stationary	131

Rotary light switch

combines the following functions:

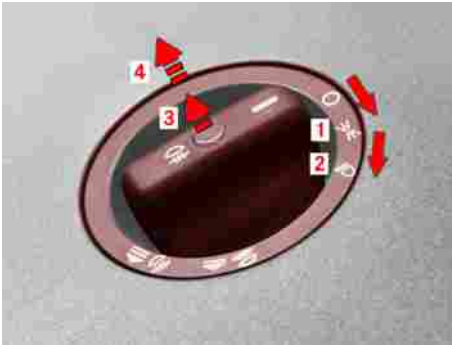

M54_00-0068-01

- 0 Switched off
- 1 Side lamps
- 2 Headlamps Dipped-beam headlamps/main-beam headlamps (depending on combination switch position) with the ignition starter switch in position 2 (drive position)

- 3 Front foglamps (pull switch to 1st detent) In addition to the side lamps, dipped-beam headlamps or main-beam headlamps if the ignition starter switch has been switched to ON
- 4 Rear foglamp (pull switch to 2nd detent) In addition to the front foglamps. The indicator lamp in the rotary light switch lights up.

Combination switch for lights and wiper functions

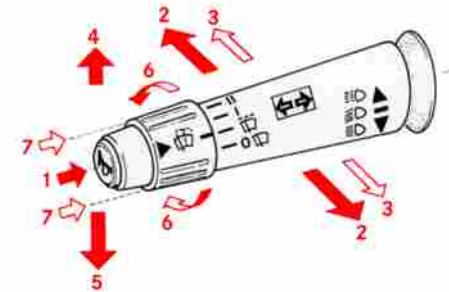

M54_00-0081-01

- 1 Horn: Press button
- 2 Indicate left and right with automatic reset: Press the switch stalk beyond the pressure point until it engages in position.
- 3 Lane change: Push the switch stalk to the stop, hold it there and release it - the stalk returns to the centre position
- 4 Headlamp flasher: Pull the stalk upwards

Combination switch for lights and wiper functions

- 5 Main-beam and dipped-beam headlamps: Lever up = dipped-beam, lever down = main-beam headlamps (in both positions until engagement)
- 6 Windscreen wipers: Turn the sleeve on the switch stalk: speed 0 = off, speed INT = intermittent, speed I = normal, speed II = rapid
- 7 Wipe and wash: Press the sleeve on the switch stalk inwards towards the steering column. With windscreen wipers switched off = windscreen wipe and wash

Driver's area controls

Combination switch for continuous brakes and cruise control (option)

Combination switch for continuous brakes and cruise control (option)

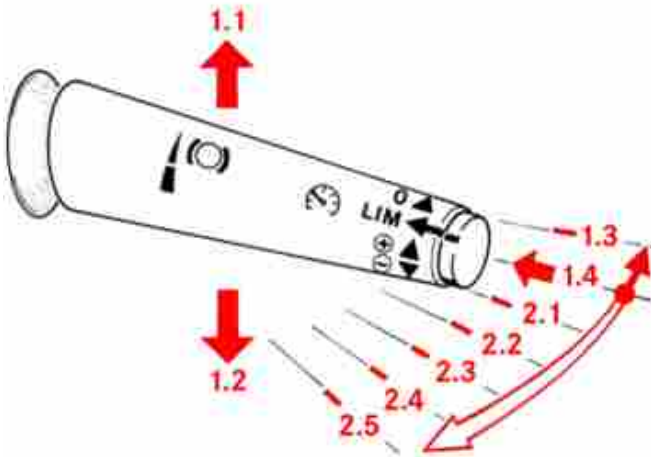

Combination switch for continuous brakes and cruise control (option)

The following functions can be activated using the combination switch:

**Note:**

Operation of the continuous brakes (retarder, engine brake, constantly open throttle)

**Note:**

Drive cruise control (constant speed by means of engine control) (option)

**Note:**

Variable speed limiter (Temposet - limitation of maximum speed) (option)

**Note:**

Engine idling speed increase

Continuous brakes

The continuous brakes cannot be activated unless the accelerator pedal is fully released, a forward drive range has been

selected and the bus is travelling faster than 3 km/h. Whenever the continuous brakes are active, the transmission is prevented from shifting into the next gear up (upshift inhibitor).

2.1 - 2.2 Engine brake flap active or engine brake flap and constantly open throttle active.

**Note:**

In these switch positions, either the engine brake flap alone is active, or both the engine brake flap and the constantly open throttle are active, depending on various factors (e.g. road speed, engine speed).

2.3 Engine brake, constantly open throttle and retarder stage 1 active.

2.4 Engine brake, constantly open throttle and retarder stage 2 active.

2.5 Engine brake, constantly open throttle and retarder stage 3 active.

**Danger.**

If the accelerator pedal is depressed while the continuous brakes are active, the continuous brakes will be deactivated and the upshift inhibitor will be cancelled.

**Danger.**

The braking effect of the retarder is automatically reduced in line with a specified oil temperature characteristic curve. The braking output is reduced.

Combination switch for continuous brakes and cruise control (option)



Danger.

As long as ABS is fully functional, an activated continuous brake will be deactivated automatically if one or both of the wheels on the driven axle threatens to lock. If an ABS fault alert is displayed, there is no guarantee that the continuous brake will be deactivated correctly - risk of skidding.



Note:

It is also possible to have the continuous brakes activated automatically by the "continuous brake integration" function (option) whenever the brake pedal is depressed.

Drive cruise control (option)

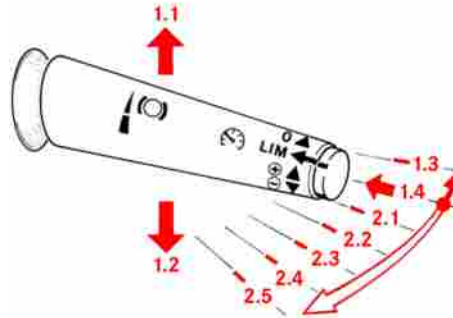

M54_00-0082-01

Drive cruise control cannot be activated unless the bus is travelling faster than 15 km/h. The service brake pedal must be fully released and the continuous brakes must not be active.

1.1 Tap briefly (< 0.5 seconds) = current driving speed is set and appears on the display screen. Tap briefly again (< 0.5 seconds) = set speed increased in increments of 0.5 km/h. Press and hold (> 0.5 seconds) = bus speed increased until switch released. When the combination switch is released, the current speed is set as the new value.

1.2 Tap briefly (< 0.5 seconds) = current speed is set and shown on the display screen, or resumption of last stored speed (memory). Tap briefly again (< 0.5 seconds) = set speed reduced in increments of 0.5 km/h. Press and hold (> 0.5 seconds) = bus speed reduced until switch released. When the combination switch is released, the current speed is set as the new value.

Combination switch for continuous brakes and cruise control (option)

1.3 Cruise control is deactivated and the last stored speed is retained by the control unit.

**Note:**

Drive cruise control is deactivated automatically as soon as the service brake is applied or the continuous brakes are activated.

**Danger.**

Do not use cruise control on a slippery road surface - there is a risk of skidding. Do not use cruise control unless road and traffic conditions permit a constant speed to be maintained. On steep uphill or downhill gradients, it may not be possible for the set speed to be maintained. Take your foot off the accelerator pedal when cruise control is active.

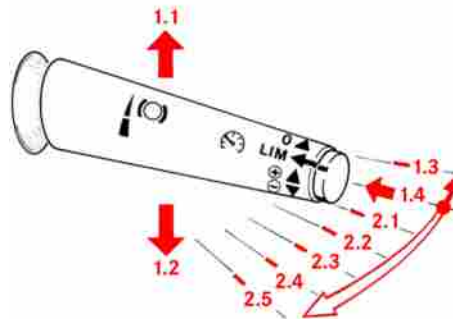
Variable speed limiter (option)

M54_00-0082-01

1.4 Press button briefly = speed limiter (LIM): The current speed is set as the maximum speed. The set value is shown on the display screen. The driver has to continue to use the accelerator pedal. Keep button pressed: The set limit speed will continue to be increased until the control is released. To deactivate: Move combination switch to position 1.3 or activate cruise control.

**Note:**

The speed limiter can be activated at speeds above 10 km/h; between 10 km/h and 15 km/h it is always limited to 15 km/h. It is possible to override the set speed temporarily by depressing the accelerator pedal beyond the stop (kickdown).

Adjustable steering column

Engine speed increase



Precondition: bus stationary, engine running.



Note:

This symbol is displayed together with a yellow alert in the event of an engine speed increase.

- 1.1 The engine speed is infinitely variable up to a maximum of 750 rpm.
- 1.3 Engine speed increase off, normal idling speed

Adjustable steering column

Pushbutton for adjusting the height and angle of the steering wheel. Set the steering column to the release position by pressing the lower section of pushbutton (1).



Danger.

Do not make adjustments unless the bus is stationary. Re-engage the steering column after you have adjusted the steering wheel to a suitable position. To do this, press the upper section of pushbutton (1).



Danger.

After the adjustable steering column has been adjusted, the driver must check that all instruments and indicator lamps are still visible.



Note:

The steering column is re-engaged automatically if pushbutton (1) is not pressed again within approximately 12 (±5) seconds.

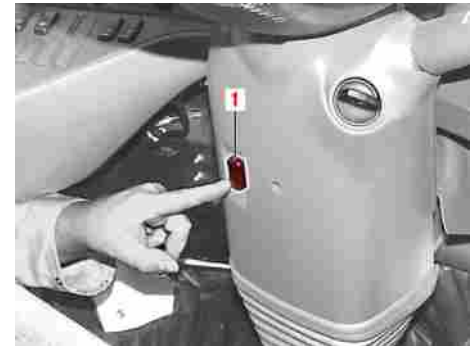

M46_00-0030-01

▷ For notes on safety and operation, refer to the “Driver's area controls” section of the Operating Instructions.

Ignition starter switch

**Danger.**

Never lock the steering while the bus is in motion. Remove the key whenever you disembark, even if only for a short time.

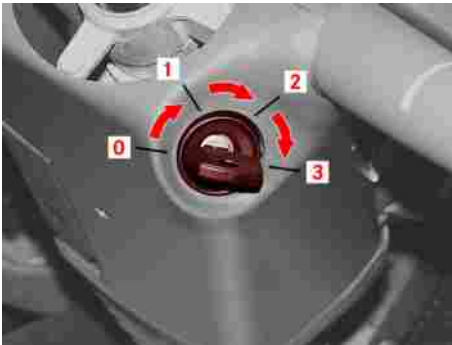

M54_00-0083-01

- 0 Parked position, insert or take out the key in this position; the side lamps can be switched on.
- 1 Steering unlocked, all consumers can be switched on.
- 2 Drive position

3 Starting position

Parking brake valve

**Danger.**

The parking brake spring actuators require a release pressure of 5.8 to 6.4 bar. At low supply pressures, there is a risk that the brake may not be fully released, that the friction pads may make slight contact while the bus is in motion and that the brake may be subjected to unnecessarily high thermal loads. The indicator lamp in the instrument display panel must go out when the parking brake is released. The emergency release device is combined with the parking brake valve and is operated in exactly the same way as the normal parking brake. The valve automatically switches over to the air reserve for the emergency release device and the spring actuators are released.

Parking brake valve



Danger.

Risk of skidding. The braking effect of ABS is cancelled if you apply the parking brake while the vehicle is in motion.



Danger.

Check hand lever (1) for full engagement. To do so, attempt to press the hand lever in the “release” direction (B) without pulling release ring (2) out of the detent position. The lever must not move.

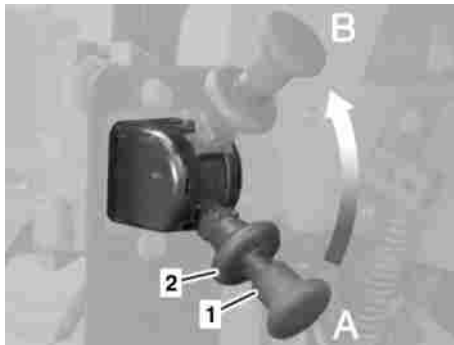

B Parking brake released

▷ For notes on safety and operation, refer to the “Operation” section.

M42_20-0003-01

A Parking brake applied

3-button automatic transmission gearshift unit

3-button automatic transmission
gearshift unit



3-button automatic transmission gearshift unit

- D Drive range D: The transmission shifts between gears 1 and 5 automatically.
- N Drive position N: Transmission in neutral. No gear is selected.
- R Drive position R: Reverse gear is selected.

Driver's area controls

6-button automatic transmission gearshift unit (option)

6-button automatic transmission gearshift unit (option)

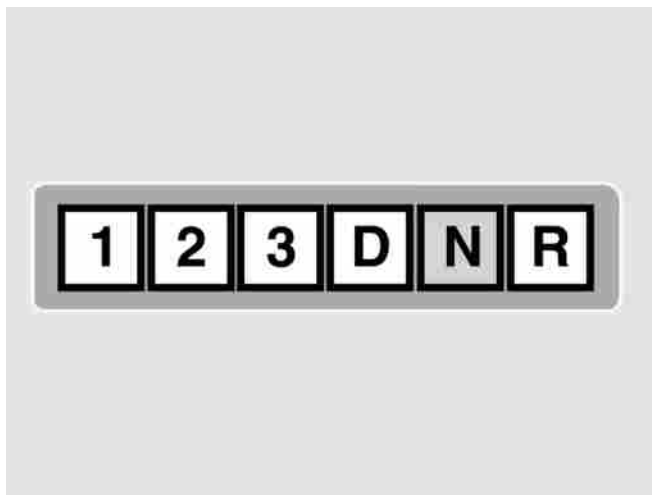

- 1 Drive range 1: Only 1st gear is selected.
- 2 Drive range 2: The transmission shifts between gears 1 and 2 automatically.
- 3 Drive range 3: The transmission shifts between gears 1 and 3 automatically.
- D Drive range D: The transmission shifts between gears 1 and 5 automatically.
- N Drive position N: Transmission in neutral. No gear is selected.
- R Drive position R: Reverse gear is selected.

Instrument display panel

Instrument display panel (INS20 10)

Detailed description

Indicator lamp for alternator 1 (1)



M54.00-1871-71

Lights up if there is a problem with the charging voltage from alternator 1.



Danger.

If the indicator lamp does not go out or if it lights up while the engine is running, stop the vehicle (traffic conditions permitting) and switch off the engine. Determine and rectify the cause (e.g. check V-belt and replace if necessary, refer to the "Practical advice" section).

Instrument display panel

Indicator lamp for hazard warning lamps/school bus warning lamps (2)

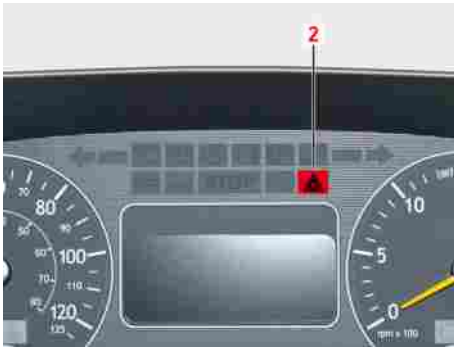

M54.00-1872-71

Lights up whenever the hazard warning lamps/school bus warning lamps are switched on.

ABS indicator lamp (3)



M54.00-1864-71

Lights up after the ignition starter switch has been switched to ON. If the display does not go out at the latest once the bus has pulled away or if it lights up while the bus is in motion, this indicates that the anti-lock braking system (ABS) and acceleration skid control (ASR) are fully or partly inoperational.



Danger.

The driving and braking characteristics of the bus may change. Adopt a cautious driving style. Have the malfunction rectified by an OMNIplus Service Partner.



Note:

The status indicator lights up red or yellow, depending on the fault severity.

Brake failure indicator lamp (5)

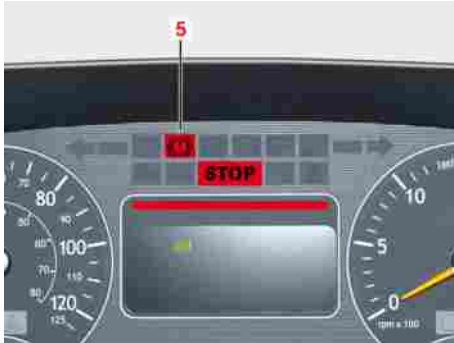

M54.00-1866-71

Insufficient supply pressure in brake circuits 1, 2 (under 6.8 bar) or 3 (under 5.5 bar).

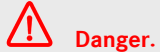

Danger.

Stop the vehicle immediately (traffic conditions permitting). Have the brake system inspected by an OMNIplus Service Partner. In the event of high compressed-air consumption (e.g. raising/lowering system in effect and bus manoeuvring), stop driving until the indicator lamp has gone out. The malfunction warning is not

cleared until the pressure has risen back above 7.2 bar.

Brake failure indicator lamp

Insufficient supply pressure in brake circuits 1, 2 (under 6.8 bar) or 3 (under 5.5 bar).

Exhaust gas cleaning system (SCR system) malfunction display (6)



M54.00-1874-71

Malfunction indicator lamp (6) lights up in the event of a malfunction in the exhaust gas cleaning system (SCR system). Malfunction indicator lamp (6) flashes in the event of a fault in the exhaust gas

cleaning system (display if concentration exceeded by more than 1.5 g/kWh NOx) or if the AdBlue® supply tank runs empty.

Parking brake indicator lamp (8)



M54.00-1862-71

“Parking brake” indicator lamp (8) lights up when the parking brake is applied.

Instrument display panel

“ASR active” indicator lamp (9)



M54.00-1861-71

Acceleration skid control (ASR) (option) prevents the drive wheels from spinning when the bus pulls away or accelerates, regardless of the road conditions. “ASR” indicator lamp (9) lights up whenever ASR is intervening and also during the display check.



Danger.

Risk of accident. ASR does not relieve the driver of the responsibility for adopting a driving style which takes traffic and road conditions into account. The bus could skid if ASR has been switched off and the drive wheels start to spin.

Continuous brake indicator lamp (10)



M54.00-1865-71

“Continuous brake” indicator lamp (10) lights up when the continuous brakes are active.



Caution:

If the indicator lamp does not go out when the continuous brakes are deactivated: do not continue to use the continuous brakes, have the malfunction rectified by an OMNIplus Service Partner.

Indicator lamp for V-belt break (11) (option)



M54.00-1878-71

Lights up if a V-belt break is detected.



Danger.

Stop the bus (traffic conditions permitting) and switch off the engine. Determine the cause and rectify it.

Indicator lamp for fire in engine compartment (12) (option)

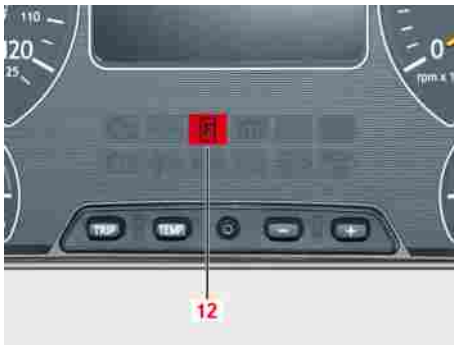

M54.00-1879-71

“Engine compartment fire” indicator lamp (12) lights up if a fire is detected in the engine compartment.



Note:

In addition to indicator lamp (12), the event is indicated by the red status lamp, the STOP warning lamp and a warning buzzer.



Danger.

Stop the bus immediately, road and traffic conditions permitting. Urge passengers to disembark. Initiate firefighting measures.

“Stop request” indicator lamp (13)

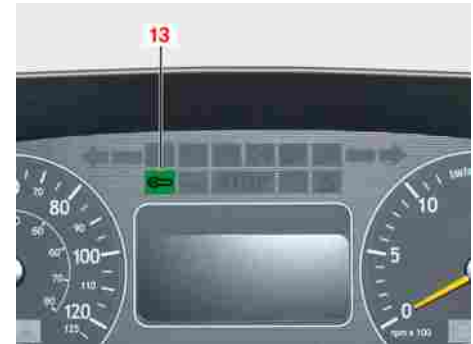

M54.00-1880-71

Lights up whenever a passenger makes a stop request.

Instrument display panel

Bus stop brake/drive-off lock indicator lamp (14)



M54.00-1867-71

“Bus stop brake/drive-off lock” indicator lamp (14) lights up when the bus stop brake or drive-off lock (option) is active.



Note:

The bus stop brake is activated whenever the switch in the instrument panel is pressed.



Note:

The drive-off lock is activated when doors are opened, for example.

Flame-start system indicator lamp (15)

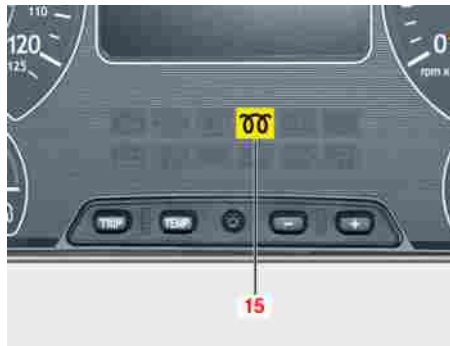

M54.00-1882-71

The flame-start system (option) is a cold-start aid for very cold outside temperatures (below $-20\text{ }^{\circ}\text{C}$) and is activated at outside temperatures of below approximately $-4\text{ }^{\circ}\text{C}$. Switch on the driving switch. “Flame-start system” indicator lamp (15) must light up. Wait until the

indicator lamp has gone out and start the engine within 30 seconds.



Environmental protection

The flame-start system reduces pollutant emissions (after the engine start) at outside temperatures of below $-4\text{ }^{\circ}\text{C}$. In addition, the starter motor and the batteries are spared and the starting time is reduced.

Continuous brake indicator lamp (10)



M54.00-1883-71

Indicator lamp (10) lights up in the event of a retarder malfunction.

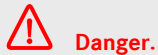
**Danger.**

Risk of accident. The retarder must no longer be used if the indicator lamp lights up in conjunction with a red warning level malfunction. Red warning level malfunctions indicate that the operating safety or roadworthiness of the bus is at risk. The driving and braking characteristics of the bus may change. The bus must be stopped immediately (traffic conditions permitting) and an OMNIplus Service Partner must be notified.

**Caution:**

The retarder must no longer be used if the indicator lamp lights up in conjunction with a yellow warning level malfunction. While it is permitted to drive on carefully, you should have the bus inspected by an OMNIplus Service Partner at the earliest opportunity.

Indicator lamp for centring of the auxiliary steering (13) (3-axle buses only)



M54.00-1884-71

Indicator lamp (13) flashes whenever centring is in progress and lights up constantly while the trailing axle is centred and locked in the centre position.

Indicator lamp for centring of the auxiliary steering (3-axle buses only)

The indicator lamp flashes whenever centring is in progress and lights up constantly while the trailing axle is centred and locked in the centre position.

MSS (automatic engine start-stop) indicator lamp (18) (option)



M54.00-1885-71

MSS indicator lamp (18) lights up while the automatic engine start-stop function is active.

Screen sequence at start-up

Red indicator lamp for alternator 2 malfunction (option) (19)



M54.00-1886-71

Lights up whenever the ignition starter switch is switched to ON and must go out when the engine is started.



Danger.

If the indicator lamp does not go out or if it lights up while the engine is running, stop the vehicle (traffic conditions permitting) and switch off the engine. Determine and rectify the cause (e.g. check V-belt and replace if necessary; refer to "Practical advice").

Red indicator lamp for alternator 3 malfunction (option) (20)



M54.00-1886-71

Lights up whenever the ignition starter switch is switched to ON and must go out when the engine is started.



Danger.

If the indicator lamp does not go out or if it lights up while the engine is running, stop the vehicle (traffic conditions permitting) and switch off the engine. Determine and rectify the cause (e.g. check V-belt and replace if necessary; refer to "Practical advice").

Screen sequence at start-up

Screen sequence at start-up

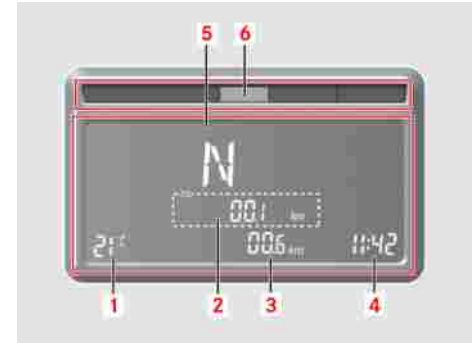

M54_30-0106-71

A warning buzzer sounds for approximately 1 second after the ignition starter switch has been switched to ON. Status indicator (6) lights up yellow. All indicator lamps in the instrument panel light up for approximately 2 seconds. Once the display check is complete, outside temperature/coolant temperature display (1), trip meter (2), total distance recorder (3), time (4) and gear/drive range indicator (5) appear on the display screen.

Display fields on the on-board computer display screen



Note:

If the on-board computer detects malfunctions in the system, the alerts are displayed in succession on the display screen and status indicator (6) lights up red or yellow.

Display fields on the on-board computer display screen

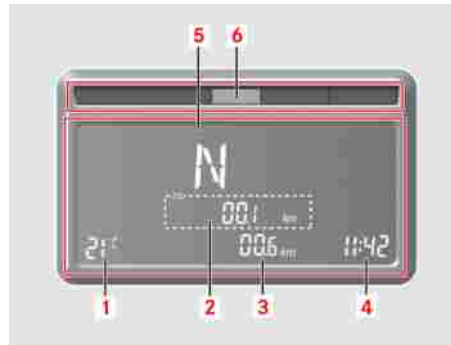

M54_30-0106-71

Outside temperature/coolant temperature display (1), trip meter (2), total distance recorder (3), time (4), gear/drive range indicator (5) and status indicator (6) appear on the display screen.



Note:

In buses with an MB GO transmission variant, only N (neutral) or R (reverse gear) is displayed on the display screen.

Toggle outside temperature/coolant temperature



M54.00-1887-71

Press button (1) to toggle the outside temperature/coolant temperature.

Display fields on the on-board computer display screen

Outside temperature

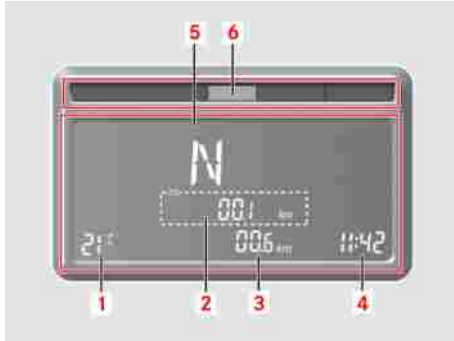

M54_30-0106-71

A minus symbol (-) before temperature reading (1) indicates that the temperature is below 0 °C.



Danger.

The road may still be icy even if the outside temperature display shows a temperature of just above the freezing point. This is especially the case in wooded areas or on bridges. Extreme changes in the outside temperature are not displayed until a delay has elapsed.

Reset trip meter to "0"



M54.00-1888-71

Press and hold button (1) to reset the trip meter to "0".



Note:

The ignition starter switch must be ON.

Setting the time

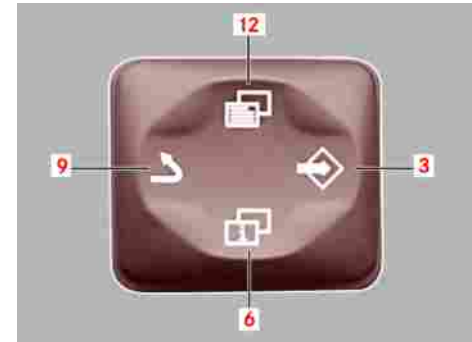

M54_30-0105-71

Press button (12) of the control rocker switch repeatedly until the time value appears on the display screen. Press button (6). The hour figures flash. To set the hours, press button (3). Press button (6). The minute figures flash. To set the minutes, press button (3). To store the set time, press button (6). Press button (9) to return to the basic display.

Adjusting the instrument lighting



Note:

If the control rocker switch is not pressed for a period of 20 seconds, the display returns to the first item in the menu and the set values are not stored.

Adjusting the instrument lighting



M54.00-1889-71

Press and hold button (1) = instrument lighting dimmer, press and hold button (2) = instrument lighting brighter



Note:

The ignition starter switch must be ON.



Note:

The brightness of the instrument lighting cannot be adjusted unless the side lamps or dipped/main-beam headlamps are switched on.



Note:

The Stop warning lamp, the indicator lamp for turn signals/hazard warning lamps and the parking brake indicator lamp cannot be dimmed and always light up at maximum brightness. Malfunction symbols appear for approximately 10 seconds at maximum brightness before fading to the brightness level set. The brightness of all other elements is infinitely variable.



Note:

The brightness level remains stored whenever the ignition starter switch is switched to position 0.

Malfunction displays: Description

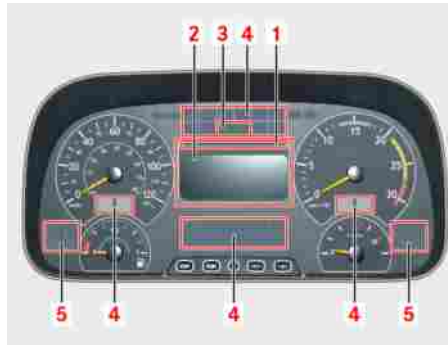

M54.00-1859-71

Display messages are operating information, malfunction alerts or warnings that are automatically displayed on display screen (2). Status indicator (1) lights up yellow or red, depending on the significance of the event. An indicator lamp (4) in the instrument panel may light up in addition to the display message being shown. Display messages can be cleared and called up at a later time. If an indicator lamp (4) lights up in addition to the display message, this will not go out even after the display message has been acknowledged. In the event of highly

significant malfunctions, the display message is accompanied by a warning tone and STOP lamp (3).



Danger.

Risk of accident. If the STOP lamp does not go out, or if it lights up while the bus is in motion, the operating safety or roadworthiness of the bus is at risk. The driving and braking characteristics of the bus may change. The bus must be stopped immediately (traffic conditions permitting) and an OMNIplus Service Partner must be notified.



Danger.

Risk of accident. Red warning level malfunctions indicate that the operating safety or roadworthiness of the bus is at risk. The driving and braking characteristics of the bus may change. The bus must be stopped immediately (traffic conditions permitting) and an OMNIplus Service Partner must be notified.

Malfunction displays: red warning level - description



Caution:

In the event of a yellow warning level malfunction, it is permissible to drive on carefully but the bus should be checked by an OMNIplus Service Partner at the earliest opportunity.

Red/yellow status indicator

To distinguish alerts on the display screen by their significance, the segment in status indicator (1) of the on-board computer lights up yellow or red. The yellow status indicator may appear in response to a particular operating state or malfunction. Malfunctions of a high priority are indicated by a red status indicator.

STOP warning lamp

Severe malfunctions are accompanied by STOP lamp (3) lighting up.

Malfunction displays: red warning level - description

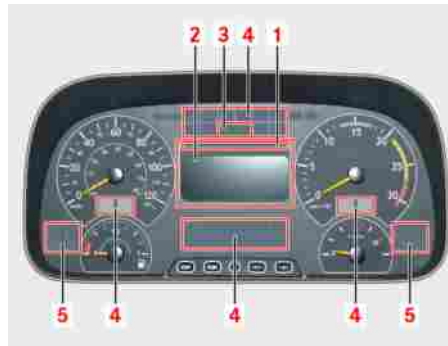

M54.00-1859-71

Red status lamp (1) lights up in the event of a high-priority malfunction.



Danger.

Risk of accident. Red warning level malfunctions (1) indicate that the operating safety or roadworthiness of the bus is at risk. The driving and braking characteristics of the bus may change. The bus must be stopped immediately (traffic conditions permitting) and an OMNIplus Service Partner must be notified.

Acknowledging red warning level display messages

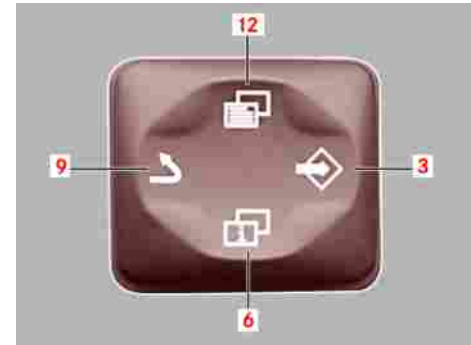

M54_30-0105-71

The driver can acknowledge display messages using pushbutton (9) of the on-board computer's control rocker switch.

Malfunction displays: red warning level - description

Viewing red warning level display messages

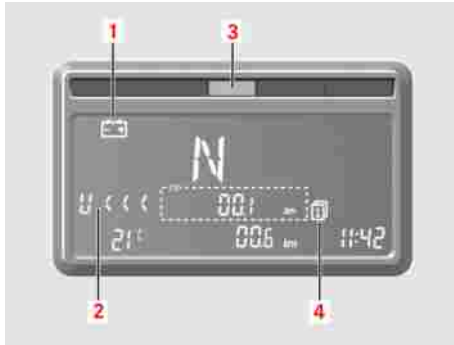

M54_30-0141-71

Whenever the driver acknowledges a display message, red warning lamp (3) goes out and malfunction symbol (1) and, if applicable, system abbreviation (2) are cleared. After the display message has been acknowledged, it is stored in the diagnostics memory, i.e. the Fault info menu, and can be called up at any time using control rocker switch button (6). Info symbol (4) on the display screen indicates the presence of a stored display message.



Note:

Depending on the priority, a warning buzzer may also sound.

Malfunction displays on the on-board computer display screen with red status indicator - overview

Malfunction displays on the on-board computer display screen with red status indicator - overview

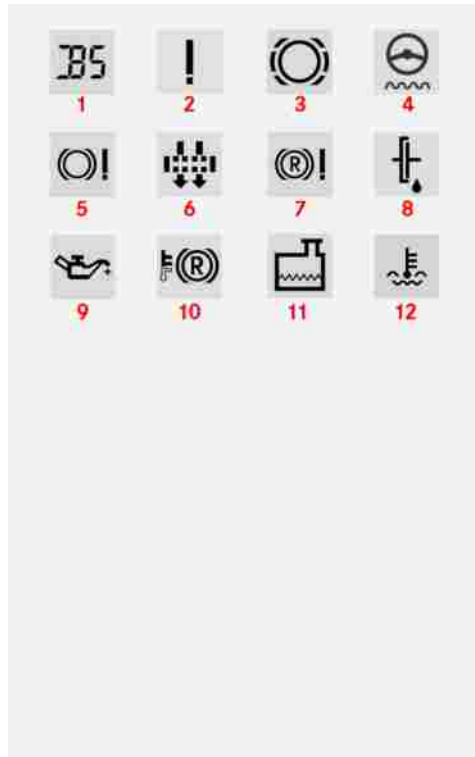

Malfunction displays: yellow warning level - description



Caution:

The brightness of the segments on the on-board computer display screen depends on the instrument lighting brightness setting. Malfunctions, however, are displayed at maximum brightness for a brief time even if the instrument lighting has been dimmed.



Note:

A system abbreviation may accompany the malfunction on the display screen, as shown in the example (1).

- 1 Brake system malfunction (example)
- 2 CAN bus malfunction
- 3 Brake pad wear
- 4 Steering oil level too low
- 5 Brake supply pressure too low

- 6 Engine air cleaner contaminated
- 7 Retarder cannot be deactivated
- 8 Oil level in the clutch fluid reservoir too low
- 9 Engine oil pressure too low
- 10 Retarder overheated
- 11 Engine coolant level too low
- 12 Engine coolant too hot (with temperature reading in °C)

Malfunction displays: yellow warning level - description

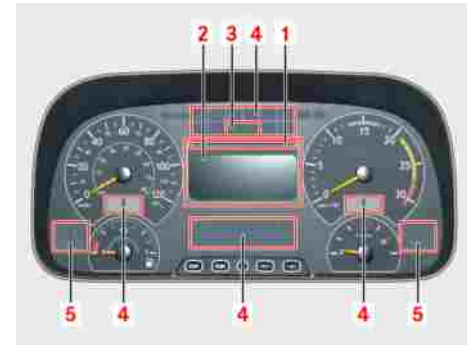

M54.00-1859-71

Yellow status lamp (1) lights up in the event of malfunctions of lower priority.



Caution:

In the event of a yellow warning level malfunction, it is permissible to drive on carefully but the bus should be checked by an OMNIplus Service Partner at the earliest opportunity.

Malfunction displays: yellow warning level - description

Acknowledging yellow warning level display messages

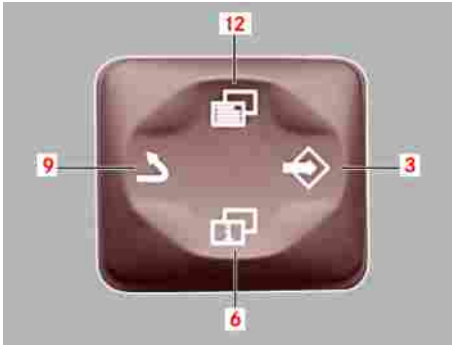

M54_30-0105-71

The driver can acknowledge display messages using pushbutton (9) of the on-board computer's control rocker switch.

Viewing yellow warning level display messages

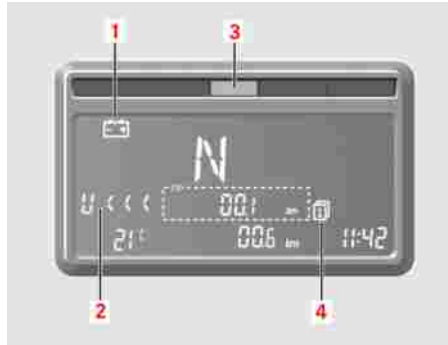

M54_30-0141-71

Whenever the driver acknowledges a display message, yellow warning lamp (3) goes out and malfunction symbol (1) and, if applicable, system abbreviation (2) are cleared. After the display message has been acknowledged, it is stored in the diagnostics memory, i.e. the Fault info menu, and can be called up at any time using control rocker switch button (6). Info symbol (4) on the display screen indicates the presence of a stored display message.

Driver's area controls

Malfunction displays on the on-board computer display screen with yellow status indicator - overview

Malfunction displays on the on-board computer display screen with yellow status indicator - overview



Malfunction displays on the on-board computer display screen with yellow status indicator - overview



Caution:

The brightness of the segments on the on-board computer display screen depends on the instrument lighting brightness setting. Malfunctions, however, are displayed at maximum brightness for a brief time even if the instrument lighting has been dimmed.



Note:

A system abbreviation may accompany the malfunction on the display screen, as shown in the example (1).

1	Brake system malfunction (example)	5	Auxiliary heating active	19	Engine oil level too low
2	Driver's door open (option)	6	Auxiliary steering oil filter dirty (option) (3-axle buses only)	20	AdBlue® reserve reached
3	Luggage compartment flap open (option)	7	Auxiliary steering oil level too low (option) (3-axle buses only)	21	Fuel reserve reached
4	Windscreen washer fluid level too low	8	Kneeling second level (option)	22	Engine protection function active
		9	Bus not at normal level (option)	23	Engine coolant too hot
		10	Raise bus (option)	24	Transmission air supply too low
		11	Lower bus (option)	25	Clutch overheated
		12	Lower target level reached (option)	26	Transmission malfunction
		13	Protection against entrapment active - kneeling process obstructed (option) (arrow flashes)	27	Auxiliary consumers supply pressure (option)
		14	Auxiliary consumers supply pressure too low (option) (arrow and encircled area flash)	28	Power take-off (option)
		15	Battery undervoltage		
		16	Cruise control active		
		17	Speed limiter active		
		18	Engine oil pressure too low		

Malfunction displays: STOP lamp - description

Malfunction displays: STOP lamp - description

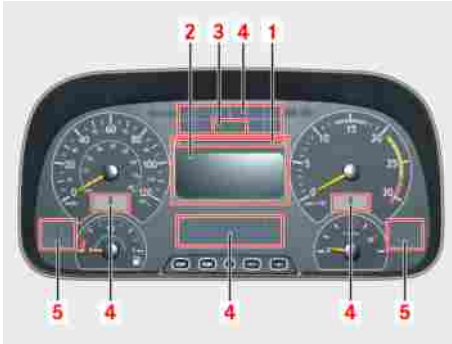

M54.00-1859-71

In the event of highly significant malfunctions, the display message is accompanied by a warning tone and STOP lamp (3)



Note:

It is not possible to acknowledge (switch off) the STOP lamp.



Danger.

Risk of accident. If the STOP lamp does not go out, or if it lights up while the bus is in motion, the operating safety or road-worthiness of the bus is at risk. The driving and braking characteristics of the bus may change. The bus must be stopped immediately (traffic conditions permitting) and an OMNIplus Service Partner must be notified.

Malfunction displays on the on-board computer display screen with red STOP warning lamp - overview

Malfunction displays on the on-board computer display screen with red STOP warning lamp - overview

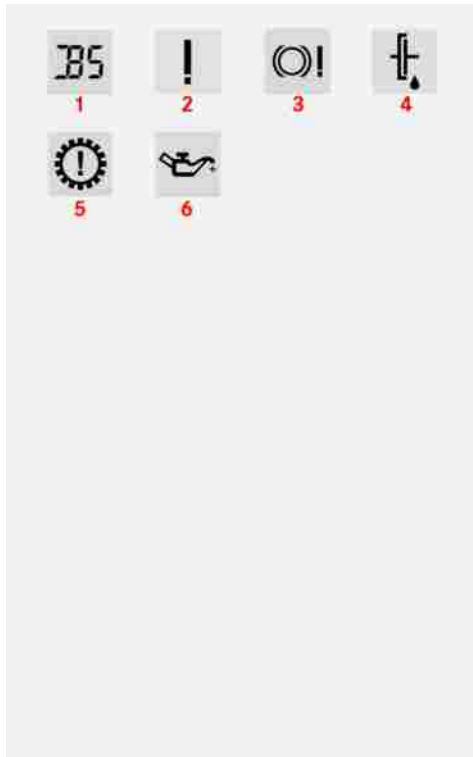

**Note:**

A system abbreviation may accompany the malfunction on the display screen, as shown in the example (1).

- 1 Brake system malfunction (example)
- 2 CAN bus malfunction
- 3 Brake supply pressure too low
- 4 Oil level in the clutch fluid reservoir too low
- 5 Transmission malfunction
- 6 Engine oil pressure too low

Display screen symbols

The following symbols may appear on the display screen:

Operating displays**Oil pressure**

The “Engine oil pressure” warning is shown on the display screen if the oil pressure in the engine is too low.

**Danger.**

Stop the bus immediately (traffic conditions permitting), switch off the engine, determine and rectify the cause. Insufficient oil pressure can result in significant damage to the engine.

Top up engine oil

The “Top up engine oil” symbol is displayed on the display screen if the oil level in the engine has dropped to the minimum level.

**Caution:**

The operating safety of the engine is at risk if the engine oil level is too low (potential engine damage). Avoid high engine speeds. Correct the oil level at the next stop. Do not overfill under any circumstances.

**Danger.**

The engine oil must be topped up immediately if the status indicator lights up red.

Display screen symbols

Engine oil overfilled



The “Engine oil overfilled” warning is displayed on the display screen if the oil level in the engine is more than 2 l above the maximum level.



Danger.

The operating safety of the engine is at risk if the engine oil level is too high (potential engine damage). Avoid high engine speeds. Siphon off or drain off at least 2 l oil. Call up the current engine oil level and correct it if necessary.

Wheel speed sensor fault



Displayed if the brake control system detects a faulty wheel speed sensor.



Danger.

The driving and braking characteristics of the bus may change. Adopt a cautious driving style. Have the malfunction rectified by an OMNIplus Service Partner.

Brake pad wear



Displayed in the event of excessive brake pad wear on one or more axles.



Danger.

The driving and braking characteristics of the bus may change. Adopt a cautious driving style. Have the malfunction rectified by an OMNIplus Service Partner.

Power steering oil level



Is displayed when the oil level in the storage tank for the power-steering pump has dropped to the minimum capacity.



Danger.

Risk of accident. Have the steering system checked for leaks by an OMNIplus Service Partner. A continued loss of oil results in a risk of accident because the steering may stiffen.

Display failure



Displayed if important operating information, warnings or events can no longer be shown on the display screen.

**Danger.**

Risk of accident. The driving and braking characteristics of the bus may change. Stop the bus (traffic conditions permitting) and switch off the engine. It is no longer possible for malfunctions that could alter driving and braking characteristics to be displayed. Have the malfunction rectified by an OMNIplus Service Partner.

Engine protection function information



The “Engine protection” operating information is displayed if the coolant temperature reaches approximately 105 °C while the bus is in motion.

**Caution:**

Engine power output is reduced automatically. Determine the cause and have it rectified if necessary by an OMNIplus Service Partner.

**Note:**

The reason why the coolant temperature is too high could be, for example, that the coolant level is too low, a drive belt is defective or poorly tensioned, or a fan clutch is defective.

Brake circuits 1-3 supply pressure



Insufficient supply pressure in brake circuits 1, 2 (under 6.8 bar) or 3 (under 5.5 bar).

**Danger.**

Stop the vehicle immediately (traffic conditions permitting). Have the brake system inspected by an OMNIplus Service Partner. In the event of high compressed-air consumption (e.g. raising/lowering system in effect and bus manoeuvring), stop driving until the indicator lamp has gone out. The malfunction warning is not cleared until the pressure has risen back above 7.2 bar.

**Note:**

The “Brake failure” indicator lamp in the indicator lamp panel also lights up.

Retarder temperature (option)



Displayed if the temperature of the retarder is too high.

Display screen symbols

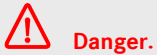

Danger.

If the retarder overheats (e.g. on a long downhill road), the retarder's braking effect will diminish: Reduce bus speed, shift down and keep the speed of the bus constant by making use of the braking effect of the engine.

Retarder malfunction (option)



Displayed if the retarder cannot be deactivated during an ABS control intervention or when the accelerator pedal is depressed.



Note:

The "Continuous brake" malfunction in the indicator lamp panel may also light up.

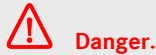

Danger.

Risk of accident. Adopt a particularly cautious driving style. Do not continue to use the retarder. Have the malfunction rectified by an OMNIplus Service Partner.

Cruise control (option)



Displayed in cruise control mode. The speed value selected is also displayed.



Note:

Cruise control mode: Refer to "Combination switch for continuous brakes and cruise control"

Speed limiter (option)



Displayed when the variable speed limiter is activated. The speed value selected is also displayed.



Note:

Activation of the speed limiter: Refer to "Combination switch for continuous brakes and cruise control"

AdBlue® reserve level



Displayed when the AdBlue® level drops to the reserve level.

Fuel reserve (option)

Displayed if the fuel level has dropped to approximately 14 % of tank capacity.

Auxiliary consumers supply pressure (option)

Displayed if the supply pressure in the auxiliary consumers circuit drops below 5.5 bar.



Danger.

If the “Auxiliary consumers supply pressure” warning is displayed on the display screen, there is a possibility of malfunctions occurring in the air suspension system, door system or clutch mechanism. Adopt a cautious driving style. Have the compressed-air system inspected by an

OMNIplus Service Partner. In the event of high compressed-air consumption (e.g. raising/lowering system in effect and bus manoeuvring), stop driving until the indicator lamp has gone out.

Door open (only if connected by the body manufacturer)

Displayed if one or more doors are open.

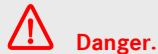

Danger.

For notes on safety and operation, refer to the operating instructions issued by the body manufacturer.

Kneeling second level (option)

This display symbol is shown if a fixed speed threshold is exceeded while the bus is at second level.

Bus not at normal level (option)

The display symbol is shown whenever the bus is not at normal level.

Raise bus (option)

The display symbol is shown when the bus is at raised level.

Display screen symbols

Lower bus (option)



The display symbol is shown during the kneeling process.

Lower target level reached (option)



The display symbol is shown when the bus is fully lowered.

Protection against entrapment active - kneeling process obstructed (option)



The symbol is shown on the display screen with a flashing arrow if the bus meets an obstacle during the kneeling

process. The kneeling process is being obstructed.

Auxiliary consumers supply pressure too low (option)



The symbol is shown on the display screen with a flashing arrow and circle if the supply pressure in the level control system (NR) is too low.



Note:

Faultless operation of the level control system (NR) is not guaranteed.

Engine coolant level



Displayed if the coolant level in the expansion tank has dropped below the minimum level.



Caution:

At the next stop, trace the cause and correct the coolant level. There is a risk of considerable damage to the engine if the coolant level is too low.



Danger.

If the status indicator lights up red at the same time, the coolant must be topped up immediately.

Windscreen washer fluid level too low



The display symbol is shown if the windscreen washer fluid level is too low.

Engine air cleaner contamination (option)

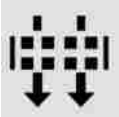

Displayed if the air cleaner is overly contaminated.



Caution:

Service the air cleaner at the next opportunity.

Auxiliary heating



The display symbol is shown when the auxiliary heating is active.

Luggage compartment flap open (only if connected by the body manufacturer)



Displayed if one or more luggage compartment flaps are open.



Danger.

For notes on safety and operation, refer to the operating instructions issued by the body manufacturer.

Battery undervoltage

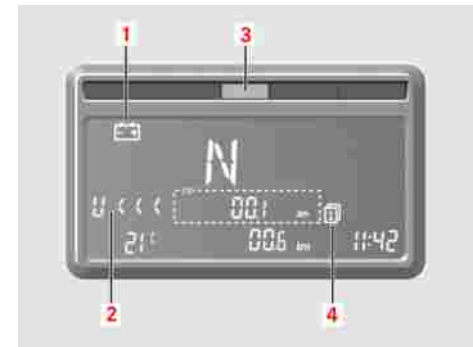

M54_30-0141-71

“Undervoltage” warning (2) is displayed on the display screen if the voltage drops below approximately 22 volts while the bus is in motion.



Danger.

The driving and braking characteristics of the bus may change. Stop the bus (traffic conditions permitting) and switch off the engine. Have the malfunction rectified by an OMNIplus Service Partner.

Vehicle manoeuvrability with the air suspension depressurised

Vehicle manoeuvrability with the air suspension depressurised

The forward section of the chassis and the guidance of the driven axle have been structurally designed in such a way as to ensure that the bus remains manoeuvrable when the suspension air bags have been depressurised.

In this condition, the full weight of the vehicle body is supported by the stop buffers fitted at the forward section of the chassis and at the rear axle. These stop buffers are unladen when the suspension is at normal level and are intended only to prevent the body of the vehicle from dropping onto the axle in the event of extreme suspension compression. The stop buffers are not designed for permanent loading and cannot be used as a replacement for the normal suspension under any circumstances. The bodywork could otherwise suffer damage (cracks, etc.).



Danger.

With the suspension depressurised, the bus does remain manoeuvrable but it must be driven no faster than walking pace to the nearest lay-by. Notify an OMNIplus Service Partner. Whenever work is carried out on the air suspension system, the body must always be supported by jacks and stands positioned at the designated points because the body of the bus could drop relatively quickly in the event of a loss of air.



Danger.

The ignition starter switch must always be switched to OFF whenever work is to be carried out on buses with electronic level control (NR) (option). This is necessary to avoid automatic "NR" adjustments while the work is being carried out.

Air suspension versions

The bus is equipped with a purely pneumatic suspension system as standard.

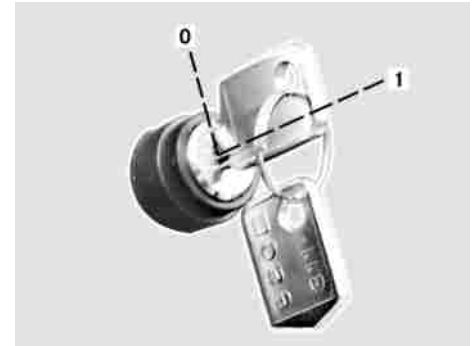

M32_00-0075-01

The bus may be equipped with an electronic level control system (NR) as an option (recognisable by the "NR" key switch on the instrument panel). This electropneumatic suspension system supports the following optional functions:

- Lean bus towards entry side (kneeling).
- Raise bus to driving ride height 2.

Lowering the bus on the boarding side (kneeling) (option)

Lowering the bus on the boarding side (kneeling) (option)

- ▶ Ignition starter switch ON
- ▶ Bus stationary
- ▶ Supply pressure in the auxiliary consumers circuit above 6.5 bar
- ▶ “NR” key switch in driving position
- ▶ Country specific and bus body manufacturer specific: doors closed.

**Danger.**

There is a risk of crush injuries to the legs and feet whenever the bus superstructure is lowered. Make sure that there are no persons or objects between the body of the bus and the road surface when the bus is being lowered. Do not use the lowering function for any purpose other than a boarding aid.

- ▶ Press the lower section of the pushbutton on the instrument panel until the bus body has fully lowered on the boarding side.

**Note:**

The bus body is automatically raised to the normal level if the pushbutton is released while the bus is lowering.



The suspension air bags on the boarding side are vented of air and the body of the bus lowers on this side.



A display symbol appears on the display screen when the bus has reached the final kneeling position.

**Note:**

The automatic bus stop brake may also be activated depending on the country and bus body manufacturer.

- ▶ Press the upper section of the pushbutton on the instrument panel.



The body of the bus is raised to normal level and the symbol goes out

Raising the bus body to driving ride height 2 (option)

Raising the bus body to driving ride height 2 (option)

- ▶ Ignition starter switch ON
- ▶ Bus stationary
- ▶ Supply pressure in the auxiliary consumers circuit above 6.5 bar
- ▶ “NR” key switch in driving position

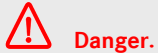

Danger.

Adopt a cautious driving style whenever the bus is at a raised level. The driving characteristics of the bus may change. The change in overall height when the bus is at raised level must be taken into consideration before the bus is driven through a tunnel or underpass.



Danger.

There is a risk of crush injuries to the legs and feet whenever the bus superstructure is lowered. Make sure that there are no persons or objects between the body of the bus and the road surface when the bus is being lowered.

- ▶ Press and hold the upper section of the pushbutton.



The bus body is raised to predefined driving ride height 2.



The “Bus at driving ride height 2” symbol appears on the display screen.

- ▶ Release the pushbutton.

The body of the bus is lowered back to normal level and the symbol goes out.



Note:

The bus body automatically returns to the normal level if the bus speed exceeds 20 km/h.

General Information / Safety Information

Important information on the steering system

The dimensions of the steering system and the mechanical steering transmission ratio were designed such that, in the event of a malfunction in the hydraulic power steering system, the effort required to turn the steering wheel would not exceed a specific value deemed by legislators to be the maximum reasonable force.

For vehicles weighing over 12 t, this maximum operating force is 450 N (400 N for vehicles between 3.5 t and 12 t) applied to the steering wheel rim in the straight-ahead position. This force must be sufficient to achieve a turning circle with a radius of 20 m at a road speed of approximately 10 km/h. No more than 6 seconds may elapse between the start of turning and the moment the 20 m radius is achieved.

The driver must be aware that, in the event of a sudden failure in the power

steering (e.g. due to a pump drive malfunction), the bus will remain steerable but considerably more effort will be required.

Since there is an extremely low probability of this situation occurring - but if it does occur, it often does so completely unexpectedly - the driver could wrongly assume that the steering system has been blocked. However, the bus does remain steerable provided the driver applies the necessary force.

This important information is intended to clarify the scenario described and prevent the driver from possibly misjudging the situation.



Danger.

In the event of a power steering failure, the bus becomes very difficult to steer. Have the malfunction rectified immediately by an OMNIplus Service Partner.

Turning the steering wheel when the bus is stationary

- ▶ We urge workshops in particular to observe these instructions.



Note:

To prevent damage to the steering column, the following points must be observed when turning the steering wheel with the bus stationary, without hydraulic support (engine switched off) and without a turntable under the front wheels (tyres in direct contact with the ground):

- ▶ Release the steering wheel adjuster and push the steering wheel fully forward and down. Lock the steering wheel adjuster in place. Turn the steering wheel using both hands placed apart at an angle of between 90° and 180°.

Turning the steering wheel when the bus is stationary



Caution:

Never have more than one person turn the steering wheel. Do not pull the steering wheel on one side only.

Instrument panel switches and pushbuttons	134
Acceleration skid control (ASR)/Electronic Stability Program (ESP) OFF	138
Diesel particulate filter (DPF) regeneration start/inhibit	138
Master safety switch (country-specific)	139

Instrument panel switches and pushbuttons

Instrument panel switches and pushbuttons



Note:

The illustrations below show the symbols marked on switches and pushbuttons. The layout of the switches and pushbuttons in the bus is determined by the body manufacturer.

- ▷ Observe the operating instructions issued by the body manufacturer.

Hazard warning lamps switch



All the turn signals on the left and right are switched on regardless of the position of the ignition starter switch. The indicator lamps in the hazard warning lamps switch and the instrument display panel flash.

Ignition starter switch (option)



All controls and display elements are supplied with power after the switch has been activated. All consumers can be switched on. Whenever the switch is switched to OFF, all consumers and the engine are switched off.



Note:

To switch off, the driver has to slide the safety catch downwards and press the upper section of the switch at the same time.



Note:

Only fitted in buses that are not equipped with a key switch on the steering column.

Engine start pushbutton (option)



Starts the engine when pressed with the ignition starter switch ON and the transmission in neutral position.



Note:

Only fitted in buses that are not equipped with a key switch on the steering column.

ASR OFF pushbutton (acceleration skid control) (option)

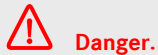

This pushbutton deactivates the ASR function. Pressing the pushbutton again or switching the ignition starter switch to OFF and back to ON reactivates the function. The indicator lamp in the indicator lamp panel flashes while ASR is switched off.

**Danger.**

Risk of accident. Acceleration skid control does not relieve the driver of the responsibility for adopting a driving style which takes traffic and road conditions into account. The bus could skid if ASR has been switched off and the drive wheels start to spin.

Horn changeover switch (option)

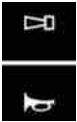

Lower section of switch pressed: electric horn. Upper section of switch pressed: air horn.

▷ For horn operation, refer to “Combination switch for light and wiper functions”.

MSS function switch (automatic engine start-stop) (option)

The automatic engine start-stop (MSS) function enables the engine to be stopped and restarted automatically on journeys involving relatively long waiting times, e.g. in city traffic or journeys with frequent pick-ups and drop-offs.



Environmental protection

The use of the automatic engine start-stop function reduces fuel consumption and is more environmentally friendly.

Auxiliary heating unit ON switch (option)



Switches on the auxiliary heating.

**Danger.**

Risk of fire and poisoning. Do not operate the auxiliary heating at filling stations and in enclosed spaces without an extraction system (e.g. in garages).

Bus stop brake switch



Whenever the switch is pressed with the bus stationary, all the wheel brakes are braked with a pressure of 2.0 bar.



Note:

Precondition: driving switch ON, bus stationary.

Instrument panel switches and pushbuttons



Note:

The bus stop brake requires less compressed air than the parking brake. At bus stops, therefore, you should give priority to the use of the bus stop brake where possible. Do not operate unless the bus is stationary.



Danger.

Always apply the parking brake correctly before you leave the driver's area. Risk of accident. To park the bus, always apply the parking brake. If necessary (e.g. on steep uphill or downhill gradients), chock the wheels as an additional measure to prevent the bus from rolling away and turn the steering towards the kerb.

▷ Observe all notes on safety and operation, and the operating instructions issued by the body manufacturer.

Drive-off lock emergency release switch (option)



In emergencies (e.g. technical defect - bus stop brake cannot be deactivated), it is possible to deactivate an active bus stop brake using the emergency release switch. This makes it possible to continue the journey.



Note:

Operation: Raise the switch cover and pull up the yellow pin. To reset the switch: Press the yellow pin in. Close the switch cover.



Danger.

Make sure that the doors and all luggage compartment flaps are securely closed before you operate the emergency switch. Adopt a cautious driving style, and always apply the parking brake when the bus is

stationary because it is no longer possible to activate the bus stop brake using the switch on the instrument panel. Have the fault rectified by an OMNIplus Service Partner as soon as possible.

Kneeling pushbutton (option)



With the lower section of the pushbutton pressed, the bus superstructure lowers on the entry side to make it easier for passengers to embark. The bus superstructure rises when the upper section of the pushbutton is pressed.



Danger.

There is a risk of crush injuries to the legs and feet whenever the bus superstructure is lowered. Make sure that there are no persons or objects between the body of the bus and the road surface when the bus is being lowered. Do not use the lowering function for any purpose other than a boarding aid.

**Note:**

Observe the notes on safety and operation issued by the body manufacturer.

**Note:**

The kneeling function is available only at a speed of below 5 km/h. The way in which the kneeling function is activated and deactivated may differ (depending on the body manufacturer and country-specific legislation).

Driving ride height 2 pushbutton (option)



Press the upper section to raise the bus superstructure to a second predefined higher driving level. Press the lower section to return the bus superstructure to normal level.

**Note:**

Driving at ride height 2 is possible only at speeds of below 20 km/h. As soon as the bus travels faster than 20 km/h, the bus superstructure will automatically lower to normal level.

**Danger.**

Adopt a cautious driving style whenever the bus is at a raised level. The driving characteristics of the bus may change. The change in overall height when the bus is at raised level must be taken into consideration before the bus is driven through a tunnel or underpass.

**Danger.**

There is a risk of crush injuries to the legs and feet whenever the bus superstructure is lowered. Make sure that there are no persons or objects between the body of the bus and the road surface when the bus is being lowered.

**Note:**

Observe the notes on safety and operation issued by the body manufacturer.

Level control key switch (only in buses with electronic level control [NR])

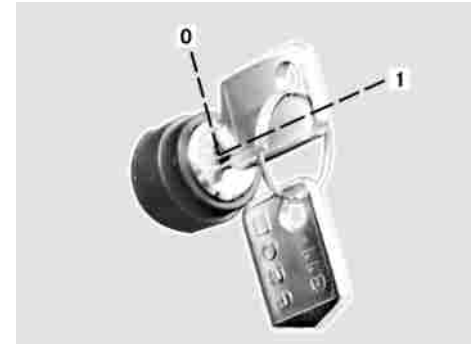

M32_00-0075-01

Position 0 = NR switched on (driving position), position 1 = “Kneeling” and “Driving ride height 2” pushbuttons disabled (NR remains functional)

Acceleration skid control (ASR)/Electronic Stability Program (ESP) OFF



Danger.

To rule out the risk of an adjustment of the air suspension system, the ignition starter switch must be switched to OFF before all work carried out under the bus and on the air suspension system.



Note:

Observe the notes on safety and operation issued by the body manufacturer.

Acceleration skid control (ASR)/ Electronic Stability Program (ESP) OFF

This pushbutton deactivates the ESP function. The dynamic handling control (FDR) and acceleration skid control (ASR) functions are also disabled. This is indicated by the yellow “ESP off” and “TC off” warning lamp. Pressing the pushbutton again or switching the ignition starter switch to OFF and back to ON reactivates the function.

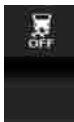

▷ For notes on safety and operation, refer to the “Operation” section of the Operating Instructions.

Diesel particulate filter (DPF) regeneration start/inhibit

Press upper section of pushbutton: Start DPF regeneration. Press lower section of pushbutton: Stop DPF regeneration or inhibit automatic DPF regeneration.



▷ For notes on safety and operation, refer to the “Operation” section of the Operating Instructions.

Master safety switch (country-specific)

Operation of the master safety switch isolates the bus electrical system from the batteries.

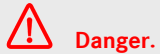

The switch is for emergency use only (e.g. accident, fire hazard due to short circuit). As the driving and braking characteristics of the bus would be affected, never operate the switch while the bus is in motion.



Operate the emergency-off switch by pressing the red knob. Unlock the switch by turning the red knob anti-clockwise.



M68_00-0234-71

Operation 142

Operation

Operation



Danger.

Risk of accident. Do not shift down on a slippery road surface (risk of skidding). Press pushbutton "N" when there is a risk of sliding and skidding.



Danger.

Buttons on the gear selection switch are illuminated when pressed down. Risk of accident. If the pressed button begins to flash, this is a warning that there is a severe risk of transmission damage (limited system monitoring). In this event, it is permitted to drive on to the nearest workshop but only with the engine under partial load.



Danger.

To prevent the bus from rolling away when parked, be sure to engage the parking brake.

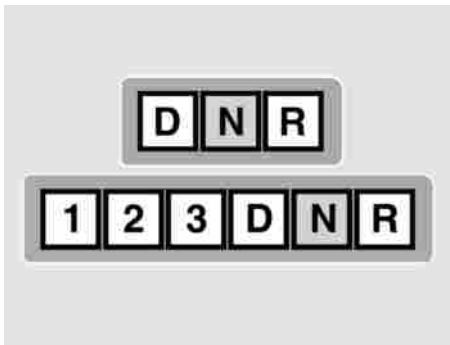

M27_00-0024-01

- ▶ To start the engine: shift the gear selection switch to neutral (N).



Note:

The engine cannot be started unless the transmission is in neutral (starter inhibitor).



Note:

The picture shows the models with 3-button gear selection switch (top) and 6-button gear selection switch (bottom) (option).

- ▶ To engage a gear: select the desired drive range or direction of travel using the gear selection switch.



Note:

Conditions: bus stationary, service brake applied, accelerator pedal in idle position and engine speed below 900 rpm.



Caution:

Never operate the gear selection switch and accelerate at the same time.

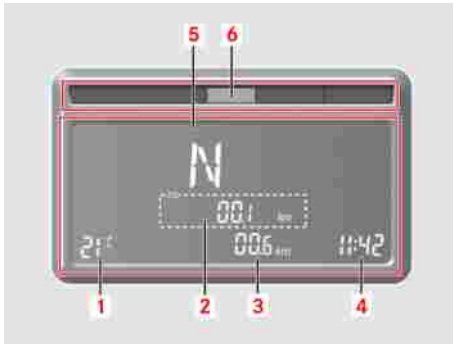

M54_30-0106-71

- ▶ The gear selected is shown on the display screen (5).
- ▶ To pull away: wait for 1-2 seconds after having selected the desired drive range.
- ▶ Release the parking brake.
- ▶ Release the service brake and accelerate.

Danger.

Do not release the brake until the bus begins to pull away. There is otherwise a risk of the bus pulling away too soon (bus creep).

Danger.

Risk of accident. On uphill gradients, release the brake and accelerate immediately to prevent the bus from rolling back.

Caution:

At temperatures of below $-15\text{ }^{\circ}\text{C}$, do not pull away immediately. Allow the engine to run and warm up for approximately 5 minutes. Gear selection switch in neutral.

- ▶ Driving: the transmission shifts through the individual gears automatically. Which gear is selected depends on: the position of the gear selection switch, the road speed, the accelerator pedal position.

Note:

The engine speed at which the transmission changes gear is dependent on the accelerator pedal position.

Accelerator pedal depressed slightly (low throttle) = early upshift

Accelerator pedal depressed far (high throttle) = late upshift

Accelerator pedal depressed beyond the full throttle position as far as the stop (kickdown) = at low engine speeds, the transmission shifts down automatically and upshifts take place at the rated engine speed.

Danger.

Risk of accident. On long downward gradients shift down manually into gear-shift position 1, 2 or 3 (option). This limits the range of upshifts. The smaller the drive range selected, the better the braking effect of the engine. However, never allow the engine speed to increase into the red zone on the rev counter. In ex-

Operation

treme situations (to protect the engine), the upshift inhibitor is cancelled and the transmission shifts up; be prepared to apply the service brake.



Danger.

Risk of accident. Shifting the transmission to “N” while the bus is in motion interrupts the flow of power between the engine and transmission output. This would mean a loss of engine and retarder braking effect; be prepared to apply the service brake.

- ▶ To reverse the direction of travel: before shifting from a forward gear (1 - D) to reverse gear (R) or vice versa: bus stationary, engine running at idling speed, gearshift unit in neutral position (N).



Danger.

Failure to observe this guideline could result in the wheels locking, which could consequently cause the bus to skid.

- ▶ Then select the desired drive range/ direction of travel (refer to “Engaging a gear”).
- ▶ Stopping: Temporary stop: leave the gearshift unit in its current position and hold the bus stationary using the service brake or bus stop brake.
- ▶ Long stops and parking: always switch the gear selection switch to neutral position “N”.



Danger.

There is no direct link between axle and engine: secure the bus against rolling away, always apply the parking brake.

- ▶ Selector positions for forward travel:
- ▶ Selector position “D”

The transmission shifts through gears 1 to 5 automatically.



Note:

Drive position “D” provides ideal driving characteristics in almost all operating situations.

- ▶ Selector position 3 (only with 6-button gear selection switch)

The transmission shifts through gears 1 to 3 automatically.



Note:

For driving on slight to moderate uphill gradients to prevent transmission hunting between 3rd and 4th gear.

On a downhill gradient, this selector position makes full use of the engine braking effect up to the maximum permissible engine speed in 3rd gear.

- ▶ Selector position 2 (only with 6-button gear selection switch)

The transmission shifts between gears 1 and 2 automatically.

**Note:**

For driving on moderate uphill gradients to prevent transmission hunting between the 2nd and 3rd gear.

On a downhill gradient, this selector position makes full use of the engine braking effect up to the maximum permissible engine speed in 2nd gear.

- ▶ Selector position 1 (only with 6-button gear selection switch)

Only 1st gear is selected.

**Note:**

For manoeuvring the bus.

On a downhill gradient, this selector position makes full use of the engine braking effect up to the maximum permissible engine speed in 1st gear.

- ▶ The automatic transmission has an integral retarder (wear-resistant auxiliary brake).

Auxiliary heating preset timer (option)	148
Operating the auxiliary heater (option)	149

Auxiliary heating preset timer (option)

Auxiliary heating preset timer
(option)

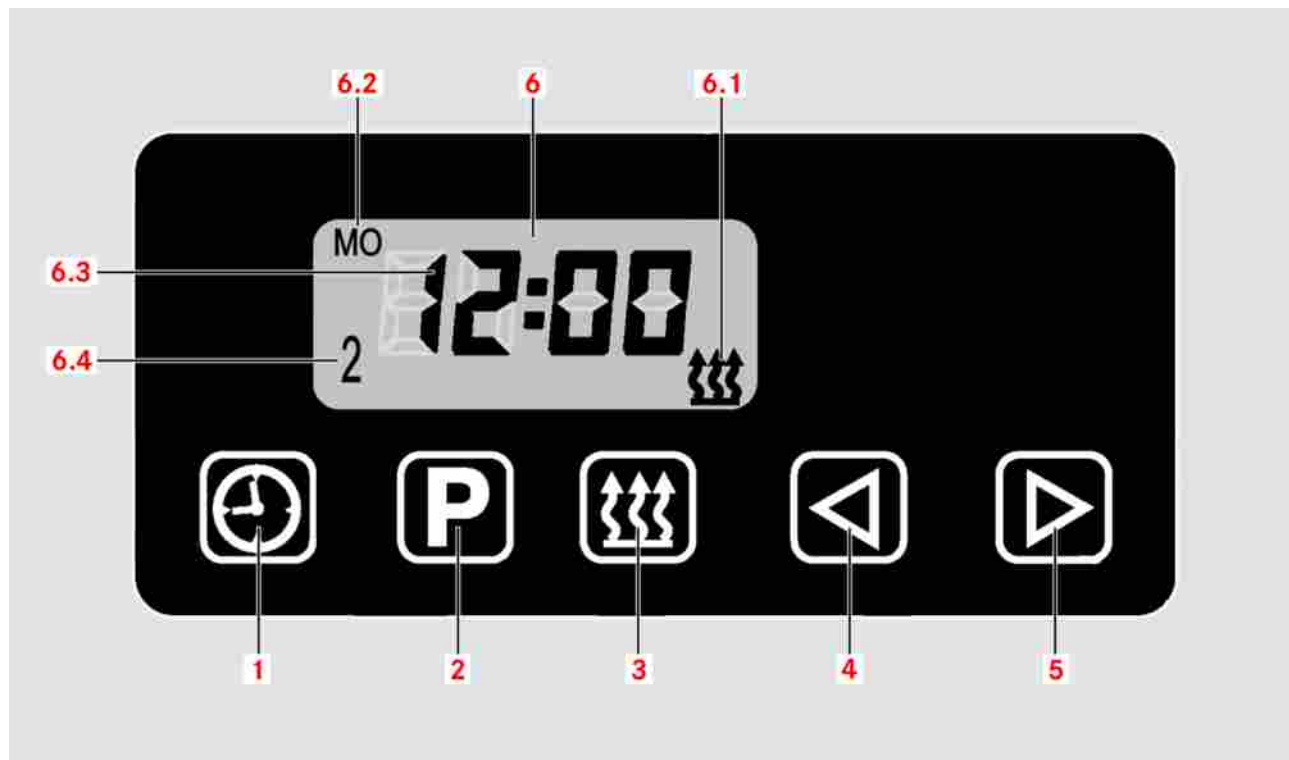

- 1 Time button: Display time/set time (press for longer than 2 seconds)
- 2 Program selection: Heating start preset time: display, set, delete
- 3 Instant heating: Switch auxiliary heating on and off manually
- 4 Back: All symbols flashing on the display screen can be adjusted using this button. Pressing this button for longer than 2 seconds activates rapid scroll.
- 5 Forward: All symbols flashing on the display screen can be adjusted using this button. Pressing this button for longer than 2 seconds activates rapid scroll.
- 6 Screen display
 - 6.1 Operating display
 - 6.2 Weekday
 - 6.3 Time display
 - 6.4 Storage location

Operating the auxiliary heater (option)



Danger.

Risk of explosion and asphyxiation. Heater operation is prohibited: at filling stations or fuel dispensing systems, in places where ignitable vapours or dust can accumulate (e.g. in the vicinity of filling stations, fuel depots, or coal, sawdust or grain stores), in enclosed spaces (e.g. bus depot).



Caution:

The heater must be operated at least once a month, with the engine cold, for at least 10 minutes.



Note:

The preset timer can be used to preselect the heating start time for a period of up to seven days. It is possible to program three switch-on times, although only one of these can be selected for activation. With the ignition starter switch ON, the

clock displays the current time and the day of the week. The display screen and buttons are illuminated while the heater is in operation. Following reconnection to the power supply, all symbols on the display begin to flash. It is necessary to reprogram the time and the weekday.



Note:

If the ignition starter switch is switched to OFF with the heater operating in continuous heating mode, a countdown time of 15 minutes will appear in the display and the heater will continue to operate until this time has elapsed.

Operating the auxiliary heater (option)

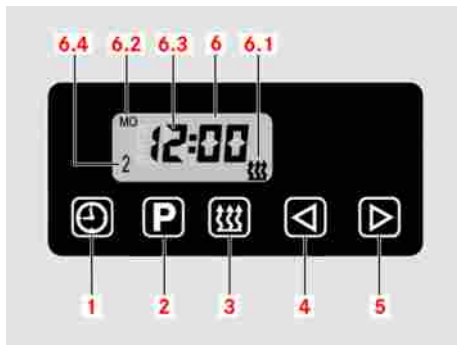

M83_00-0730-71

- ▶ All flashing symbols can be set using buttons (4 and 5). The displayed time is stored automatically if 5 seconds elapse with no button being pressed. Pressing button (4) or (5) for longer than 2 seconds activates rapid scroll.
- ▶ To switch on the auxiliary heater with preset timer: press button (3).
The auxiliary heating is switched on manually.

- ▶ To switch off the auxiliary heater: press button (3) again.
The auxiliary heating is switched off manually.
- ▶ To view the time with the ignition starter switch OFF: press button (1).
- ▶ To set the time/day: press and hold button (1) for longer than 2 seconds
Time (6.3) flashes.
- ▶ Set the time using buttons (4) and (5).
Now the weekday (6.2) flashes and can be set using buttons (4) and (5).
- ▶ To program the start of heating: press button (2).
Preset 1 (6.4) flashes.
- ▶ Set the time using buttons (4) and (5).
Weekday (6.2) flashes.

- ▶ Set the weekday using buttons (4) and (5).
Time (6.3) flashes.



Note:

To set presets 2 and 3 (6.4), press button (2) repeatedly to display the preset concerned and then proceed as described above.

- ▶ To view the preset times: press button (2) repeatedly until the desired preset is displayed.
- ▶ To clear the preset time: press button (2) repeatedly until the time but no preset is displayed.
- ▶ To program the switch-on duration: the heater must be OFF. Press and hold button (4) for longer than 3 seconds.
Switch-on duration flashes

- ▶ Set the desired switch-on duration using buttons (4) and (5).



Note:

The switch-on duration can be set to any value between 10 and 120 minutes.

- ▶ To set the countdown time: set the desired countdown time using buttons (4) and (5).



Note:

The countdown time is the time for which the heater will remain in operation. The countdown time cannot be adjusted unless the heater is currently in operation and the ignition starter switch is OFF.



Note:

The countdown time can be set to any value between 10 and 120 minutes.

Driving systems (overview)	154
Variable speed limiter (TempoSet)	154
Activating the variable speed limiter (TempoSet)	155
Combined drive/brake cruise control	157
Activating combined drive/brake cruise control	158
Operating/malfunction displays: driving systems	159
Engine speed increase	162

Driving systems (overview)

Driving systems (overview)

The bus may be equipped with the following driving systems:

- Variable speed limiter (TempoSet)
- Cruise control (combined drive/brake cruise control)

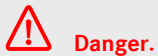

Danger.

The driving systems listed are merely aids to assist the driver, e.g. to drive at a preselected road speed. It is always the driver's responsibility to ensure that the actual driving speed and the distance from the vehicle in front are safe and appropriate.



Caution:

In the case of buses with manual transmission, the driver must be prepared to change gear in order to regulate engine speed whenever the bus is being accelerated or decelerated by cruise control.

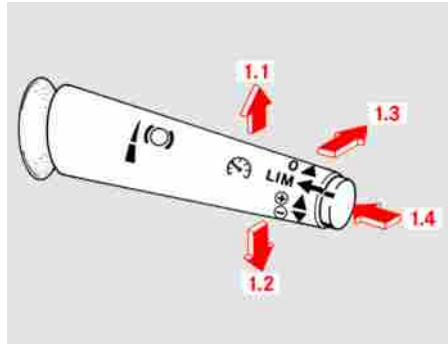

M54_00-1003-01

It is possible to switch between the variable speed limiter (TempoSet) and drive/brake cruise control driving systems at any time while the bus is in motion by pressing button (1.4). The symbol for the selected driving system is shown on the display screen.

▷ For further notes on operation, refer to “Combination switch for retarder and cruise control” in the “Driver's area controls” section.

Variable speed limiter (TempoSet)

The speed limiter enables the driver to set any speed above 15 km/h as a limit speed. Using the accelerator pedal, it is no longer possible to exceed the limit speed set.



Danger.

The speed limiter regulates the speed of the bus automatically in order to prevent it from exceeding the set limit speed. The speed limiter is unable to interpret road and traffic conditions itself.



Note:

The retarder is activated automatically if the set limit speed is exceeded by more than 4 km/h in overrun mode.

Activating the variable speed limiter (TempoSet)

**Danger.**

The speed limiter is only an aid designed to assist driving. You are responsible at all times for the speed of the bus and for maintaining an adequate distance to the vehicle in front. Do not use the speed limiter unless traffic conditions permit a constant speed to be maintained.

Activating the variable speed limiter (TempoSet)

**Note:**

It is possible to exceed the stored limit speed, e.g. when overtaking. To do this, depress the accelerator pedal briefly beyond the full-throttle position as far as the stop. As soon as the overtaking manoeuvre is over, release the accelerator pedal briefly and depress it again. This will reactivate the set limit speed.

**Note:**

If the bus is travelling faster than the stored limit speed at this time, the bus will be decelerated automatically by the retarder.

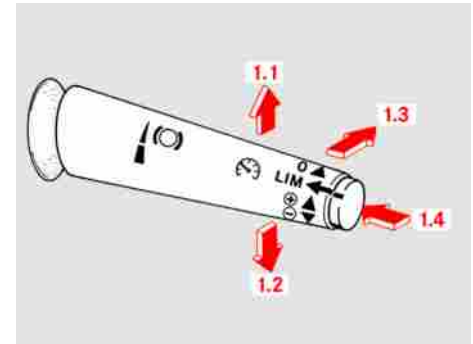

M54_00-1003-01

- ▶ Press function toggle button (1.4) repeatedly until LIM appears on the display screen

The variable speed limiter is now selected.

- ▶ Move the steering column switch to position (1.1).

The variable speed limiter is now activated.

Activating the variable speed limiter (TempoSet)

- ▶ Use the accelerator pedal to accelerate the bus up to the desired speed.
- ▶ Briefly move the steering column switch to position (1.1).



M54_30-0121-71

The “LIM” icon and the stored maximum speed are shown on the display screen whenever the variable speed limiter is active.



Note:

Briefly pressing the steering column switch to position (1.1) or (1.2) now increases or reduces the stored limit speed in increments of 0.5 km/h respectively.

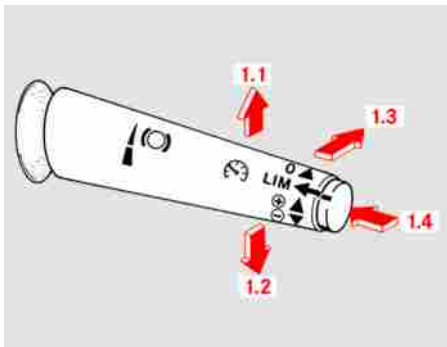

M54_00-1003-01

- ▶ Hold the steering column switch in position (1.1) or (1.2) for some time. The limit speed is increased or reduced in increments of 5 km/h respectively.

- ▶ Release the steering column switch. The selected limit speed is stored.

Combined drive/brake cruise control

Combined drive/brake cruise control is able to control both the engine and the retarder. The system maintains a stored cruising speed provided there is sufficient engine power output or retarder braking torque available (with a tolerance of +4 km/h on downhill gradients). On level surfaces and on uphill gradients, the speed is regulated by the engine (drive cruise control). On downhill gradients, the speed is regulated by the retarder (brake cruise control). The speed is maintained constant only for as long as the braking performance of the retarder remains sufficient for this to be possible. Whenever necessary, shift down and reduce speed manually.



Danger.

To maintain the stored speed, combined drive/brake cruise control automatically operates either the engine control in order to accelerate the bus (drive cruise control) or the engine brake and retarder to decelerate the bus (brake cruise control). Combined drive/brake cruise control is unable to interpret road and traffic conditions itself. For this reason, do not activate combined drive/brake cruise control on slippery road surfaces, in fog or in difficult road and traffic conditions. You could fail to recognise dangers in good time, and endanger yourself and others. When driving on a slippery road surface, the wheels could lock and the bus could skid.



Danger.

The cruise control function is only an aid designed to assist driving. The driver is responsible at all times for the speed of the bus and for maintaining an adequate distance to the vehicle in front. Do not use cruise control unless traffic

conditions permit a constant speed to be maintained. On steep uphill or downhill gradients, it may not be possible for a constant speed to be maintained. Take your foot off the accelerator pedal when cruise control is active.



Note:

The retarder may be activated for additional braking force. The cruise control system will remain active. The service brake may also be applied while the bus is being braked by the retarder. The cruise control system will remain active. If cruise control is braking the bus using the retarder, the retarder will not be deactivated if the service brake is then applied. As soon as the retarder is deactivated, the bus will accelerate to the previously stored speed.

Activating combined drive/brake cruise control

Activating combined drive/brake cruise control



Note:

Precondition: Bus travelling faster than 15 km/h. The clutch and service brake pedals must be fully released and the continuous brakes must not be active.



Note:

The speed is maintained constant only for as long as the braking performance of the retarder remains sufficient for this to be possible. Whenever necessary, shift down and reduce speed manually.



Note:

It is possible to exceed the stored speed, e.g. when overtaking. To do this, depress the accelerator pedal. When the overtaking manoeuvre is over, release the accelerator pedal again. Cruise control will regulate the speed of the bus to the stored cruising speed.

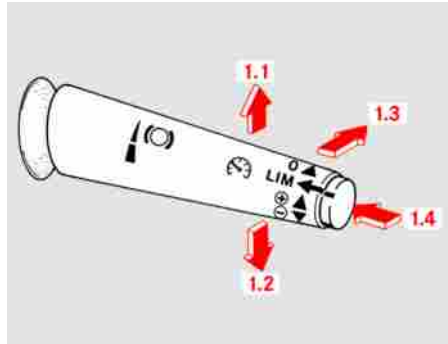

M54_00-1003-01

- ▶ Briefly move the steering column switch to position (1.1) or (1.2) (< 0.5 seconds).



Note:

Moving the steering column switch to position (1.2) enables you to call up a previously stored speed.



M54_30-0122-71

The cruising speed set is shown in the display.



Note:

Brief movement to position (1.1) or (1.2) (< 0.5 seconds) increases/reduces the set speed in increments of 0.5 km/h respectively.



Note:

Holding the steering column switch (> 0.5 seconds) in position (1.1) or (1.2) accelerates or decelerates the bus. When the combination switch is released, the current speed is set as the new value.



M54_30-0123-71

After a brief delay, the cruising speed set (3) appears on the display screen along with “cruise control” icon (2) (see illustration).

- ▶ Move the steering column switch to position (1.3).

Combined drive/brake cruise control is deactivated. Cruise control is deactivated automatically:

- if the bus is braked by means of the service brake and cruise control is currently in operation. The speed set remains stored.
- if the speed of the bus drops below 15 km/h, in which case a short warning signal will sound. The speed set remains stored.
- if the clutch is operated for longer than 5 seconds, e.g. during a gear-shift. A short warning signal will sound.
- if the transmission is shifted to the neutral position for longer than 5 seconds. A short warning signal will sound.

Operating/malfunction displays: driving systems

Overspeeding warning message (option)

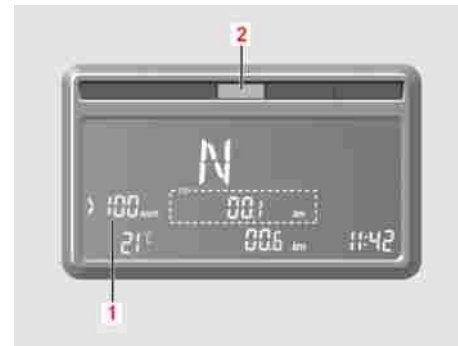

M54_30-0130-71

Depending on the customer's specification, warning message (1) may be displayed on the instrument cluster display screen together with a red warning level malfunction (2) if a permanently defined speed (100 km/h in the example) is exceeded. A warning tone also sounds.

Operating/malfunction displays: driving systems



Danger.

To avoid the risk of endangering passengers and other road users, it will be necessary to brake the bus using the service brake.



Note:

The menu that was displayed at the time of the warning returns to the display screen as soon as the speed of the bus drops back below the defined maximum speed.



Note:

The driver is not able to change the permanently defined speed.

Engine speed increase

Engine speed increase

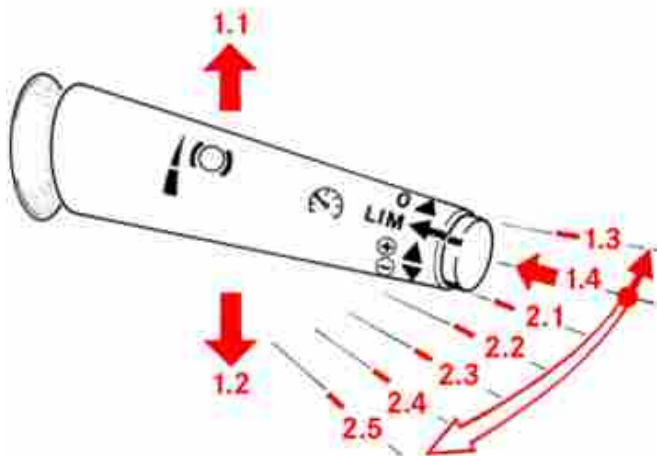

Engine speed increase (option)

Precondition: bus stationary, engine running.

**Note:**

This symbol is displayed together with a yellow alert in the event of an engine speed increase.

- 1.1 The engine speed is infinitely variable up to a maximum of 750 rpm.
- 1.3 Engine speed increase off, normal idling speed

**Note:**

Combination switch, illustration similar

Safety precautions for work carried out in the engine compartment	168
Electric fuel pump (option)	168
Checking the engine oil level with the dipstick	169
Checking the coolant level of the engine and heating system	170
Removing the drive belts (OM 936)	171
Fitting the drive belts (OM 936)	173
Tyres - operating safety and roadworthiness	177
Tyre pressure	177
Tyre tread	178
Tyre condition	178
Tyre age	178
Invisible tyre damage	179
Tyre load capacity, top speed of tyres and types of tyres	179
Retreaded tyres	180
Tyre pressures table 275/70 R 22.5	182
Tyre pressures table 11 R 22.5	184

Table of contents

Tyre pressures table 295/80 R 22.5	186
Safety measures to be taken in the event of a flat tyre or a wheel change	187
Positioning the jack	188
Removing the wheel trims	189
Fitting a wheel nut cover cap	189
Removing a wheel	191
Fitting wheels	191
Inflating tyres using the tyre inflator connection	193
Pneumatic test ports	196
Charging the compressed-air system (option)	197
Checking the oil level in the steering hydraulics expansion tank	198
Replacing the fuel filter for the auxiliary heater (option)	199
Electrical system safety precautions	201
Safety precautions for handling batteries	201
Measures required for the prevention of damage to buses or components during electric welding work	202

Fuse assignment for driver's area switch panel	204
Fuse assignment (main fuses) for auxiliary switch panel	208
Handling fuses	210
Disconnecting vehicle batteries	211
Recharging vehicle batteries	212
Notes on jump-starting	212
Jump-start procedure	213
On-board diagnostics	214

Safety precautions for work carried out in the engine compartment

Safety precautions for work carried out in the engine compartment

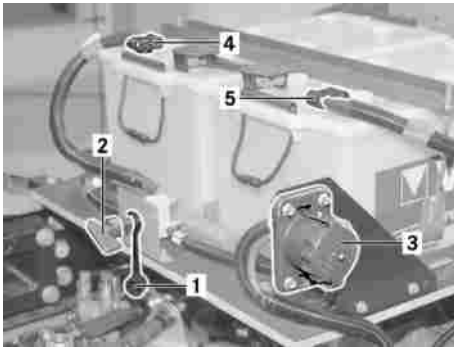

M54_00-0806-01

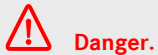

Danger.

Risk of fatal injury. Freely rotating parts in the area of the running engine and the drive train can cause serious injuries. Never leave the engine running when work is carried out in the engine compartment. Prevent the engine from being switched on without authorisation. To do this, switch off and pull out the battery isolating switch (2).



Danger.

Risk of burns. Hot components in the engine compartment may cause burns. If the engine is at operating temperature, leave it to cool down.

Electric fuel pump (option)

The electric fuel pump can be used to bleed the fuel system. Press button (1) briefly to switch on the electric fuel pump. The pump will switch off after 85 seconds.

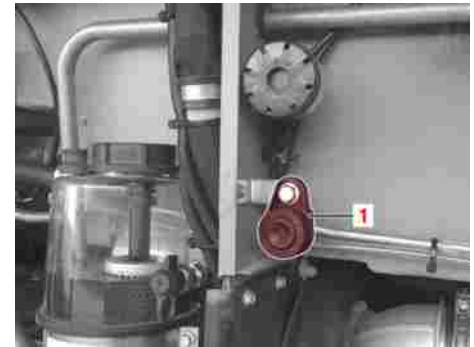

M47_00-0121-71

Checking the engine oil level with the dipstick

Checking the engine oil level with the dipstick



Danger.

Risk of fatal injury. Freely rotating parts in the area of the running engine and the drive train can cause serious injuries. Never leave the engine running when work is being carried out in the engine compartment. Prevent the engine from being switched on without authorisation. To do this, switch the battery isolating switch to OFF and pull it out.



Danger.

Risk of burns. Hot components in the engine compartment may cause burns. If the engine is at operating temperature, leave it to cool down.

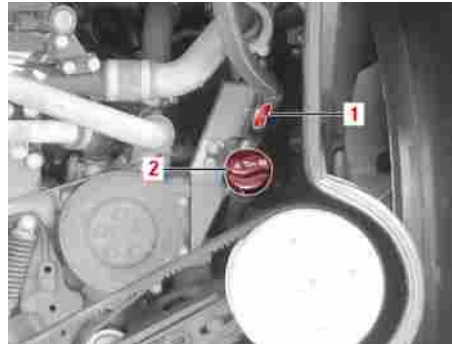

M01.00-0147-71

- ▶ Pull out dipstick (1) with the engine switched off and at normal operating temperature.



Note:

The oil level must be visible between the 2 arrows on dipstick (1).



Note:

The oil level must be checked with the bus standing horizontal.



Note:

After you have switched off the engine, wait approximately 10 minutes to allow the oil to collect in the oil sump.

- ▶ At filler opening (2), add the top-up volume required in accordance with the Specifications for Service Products. Then make sure that the filler cap is firmly and correctly seated.



Note:

We recommend that you do not top up the engine oil unless it has dropped to the "MIN" mark. In this case, top up the engine oil to the "MAX" mark.

Checking the coolant level of the engine and heating system



Caution:

Avoid overfilling. The engine may be damaged if the oil level is too high.

Checking the coolant level of the engine and heating system

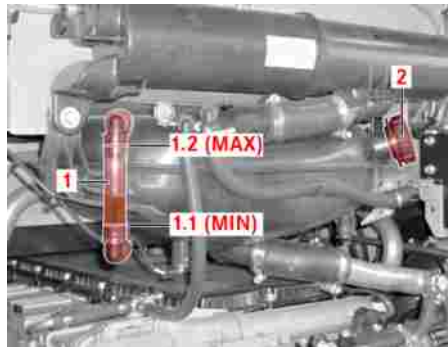

M20.00-0144-71

- Read off the coolant level



Danger.

Risk of scalding to skin and eyes from hot coolant spraying out. Wear protective clothing (gloves/safety goggles). Do not open sealing cap (2) on the coolant expansion tank unless the coolant temperature is below 50 °C. Open sealing cap (2) slowly to relieve the excess pressure. Slowly turn the sealing cap a little further and remove it. Risk of poisoning if coolant is swallowed.



Note:

The coolant level must be between the upper and lower marks (minimum (1.1) and maximum (1.2)) at expansion tank inspection glass (1) when the engine is cold (below 50 °C).

- Add coolant



Caution:

Do not top up unless the engine is cold.



Note:

Use clean water – well filtered and as soft as possible (drinking water quality) – mixed with corrosion inhibitor/antifreeze (comply with the Specifications for Service Products).

Removing the drive belts (OM 936)



Note:

Only the use of a coolant specified on MB Specifications for Service Products sheet 325.5 or 326.5 (G40) is permitted. (The colour of the coolant is pink.)



Note:

For notes on bleeding the heating system coolant circuit, refer to the “Practical advice” section.

Removing the drive belts (OM 936)



Danger.

Risk of fatal injury. Freely rotating parts in the area of the running engine and the drive train can cause serious injuries. Never leave the engine running when work is being carried out in the engine compartment. Prevent the engine from being switched on without authorisation. To do this, switch the battery isolating switch to OFF and pull it out.



Danger.

Risk of burns. Hot components in the engine compartment may cause burns. If the engine is at operating temperature, leave it to cool down.



Caution:

Replacement V-belts and some of the tools listed below are not supplied with the bus as standard. Only the use of OMNIplus original replacement V-belts is permitted.

Removing the fan drive belts (OM 936)

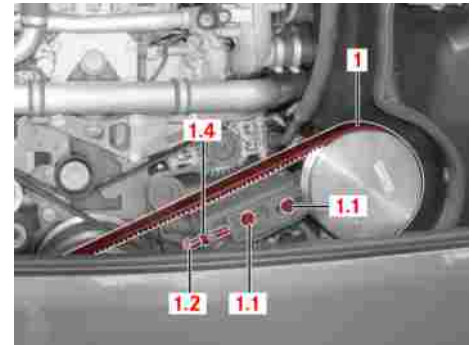

M54.00-2104-71

- ▶ Loosen lock nut (1.4) of adjustment screw (1.2) on the belt tensioner carrier.
- ▶ Unscrew adjustment screw (1.2).
- ▶ Loosen screws (1.1) securing belt pulley tensioning lever mounting.
- ▶ Move tensioning lever mounting with belt pulley to the stop against the carrier and remove the drive belt.

Removing the drive belts (OM 936)

Removing the drive belt for the alternator bottom right

i **Note:**

Required tools: screwdriver, 1/2" tommy bar, 1/2" extension, WAF 19 socket spanner, WAF 19 open-ended spanner.

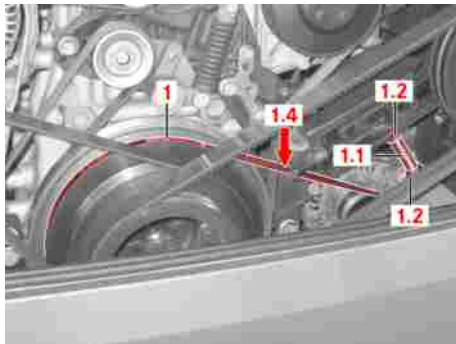

M54.00-2105-71

- ▶ Loosen lock nut (1.2).
- ▶ Loosen tensioning screw (1.1) until the drive belt is lying loosely on the belt pulleys.
- ▶ Remove drive belt (1) from the belt pulleys.

Removing the refrigerant compressor drive belt (OM 936)

i **Note:**

Required tools: 1/2" tommy bar.

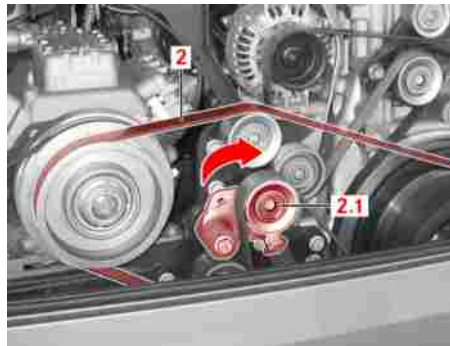

M01_00-0134-71

- ▶ Fit the 1/2" tommy bar into tensioning pulley (2.1), pull the tensioning pulley upwards in the direction of the arrow using the tommy bar and hold in place.
- ▶ Remove the drive belt from the belt pulleys.

Removing the drive belt for the left-side alternator (OM 936)

i **Note:**

Required tools: WAF 19 straight ring spanner, WAF 19 open-ended spanner, WAF 17 open-ended spanner.

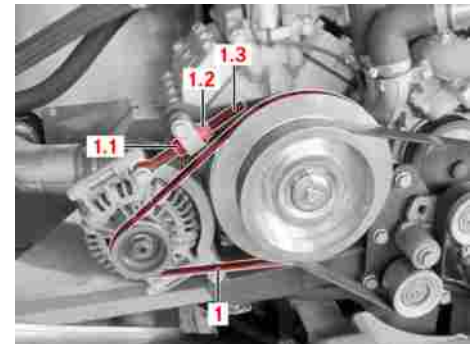

M54.00-2106-71

- ▶ Loosen lock nut (1.2) and loosen tensioning nut (1.1) until the drive belt is lying loosely on the belt pulleys.
- ▶ Remove drive belt (1) from the belt pulleys.

Removing the drive belt for the water pump and centre alternator

i Note:

Required tools: WAF 15 ring spanner, drift punch or small screwdriver.

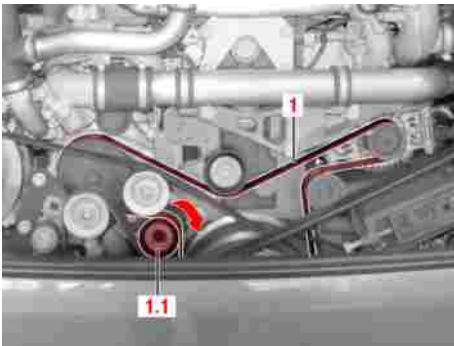

M54.00-2107-71

- ▶ Remove the drive belt from the belt pulleys.

Fitting the drive belts (OM 936)



Caution:

During assembly, do not use force (e.g. with the use of an assembly lever) when pulling drive belts over the belt pulley edges. Doing so could result in hidden damage to the cord, which would considerably reduce the service life of the belt.

- ▶ Fit the ring spanner into tensioning pulley (1.1), pull the tensioning pulley down in the direction of the arrow and hold in place.
- ▶ Secure the tensioning pulley by pegging it with a drift punch or a small screwdriver.

Fitting the drive belts (OM 936)

Fitting the drive belt for the left-side alternator (OM 936)

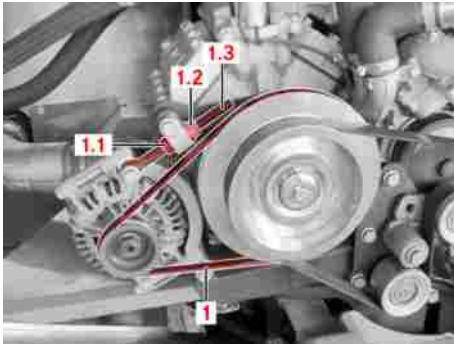

M54.00-2106-71

- ▶ Place new drive belt (1) on the belt pulleys of the refrigerant compressor and alternator.
- ▶ Tighten tensioning nut (1.1) using an open-ended spanner until the required belt tension has been achieved.



Note:

The drive belt tension must not be too high under any circumstances. It must still be possible to twist the drive belt through at least 90° at measuring point (4.5) using two fingers.



Caution:

Visit an OMNIplus Service Partner.

- ▶ Tighten lock nut (1.2) of the tensioning spindle using an open-ended spanner.

Fitting the drive belt for the water pump and centre alternator

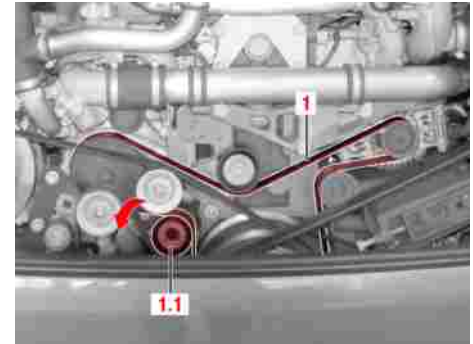

M54.00-2119-71

- ▶ Manually lay new drive belt (1) on the belt pulleys for the crankshaft and on the idler pulley and belt pulley for water pump and alternator.
- ▶ Fit the ring spanner into tensioning pulley (1.1), pull the tensioning pulley in the direction of the arrow using the ring spanner and hold in place.
- ▶ Lay drive belt (1) on tensioning pulley (1.1).

Fitting the drive belts (OM 936)

Fitting the drive belt to the right-side alternator (OM 936)

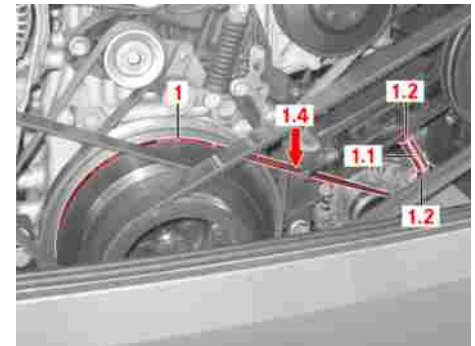

M54.00-2105-71

- ▶ Manually lay new drive belt (1) over the belt pulleys for the crankshaft and the alternator.
- ▶ Tighten the tensioning screw until the required belt tension has been achieved.



Note:

Tensioning pulley (1.1) is spring-loaded; the drive belt is therefore adjusted to the correct tension automatically.

Fitting the water pump and the refrigerant compressor drive belt (OM 936)

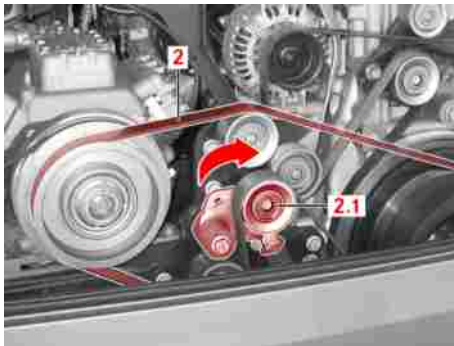

M01_00-0134-71

- ▶ Manually lay new drive belt (2) on the belt pulleys for the crankshaft and on the idler pulley and belt pulley for the refrigerant compressor.

- ▶ Fit the 1/2" tommy bar into tensioning pulley (2.1), pull the tensioning pulley in the direction of the arrow using the tommy bar and hold in place.
- ▶ Lay drive belt (2) on the tensioning pulley.



Note:

Tensioning pulley (2.1) is spring-loaded; the drive belt is therefore adjusted to the correct tension automatically.

Fitting the drive belts (OM 936)



Note:

The drive belt tension must not be too high under any circumstances. It must still be possible to twist the drive belt through at least 90° at measuring point (2.5) using two fingers.



Caution:

Visit your nearest OMNIplus Service Partner to have the drive belt tension adjusted correctly using a tension meter.

- ▶ Tighten lock nuts (1.2) of the tensioning screw using an open-ended spanner.

Fitting the fan drive belt (OM 936)



Note:

Only ever replace the fan drive belts in pairs.

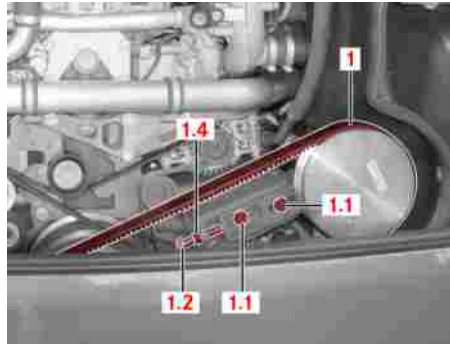

M54.00-2104-71

- ▶ Manually lay new drive belt (1) on the belt pulleys for the crankshaft and fan drive.
- ▶ Screw adjustment screw (1.2) into the carrier until it makes contact with the tensioning lever mounting.



Note:

The drive belt tension must not be too high under any circumstances. It must still be possible to twist the drive belt through at least 90° at the measuring point using two fingers.



Caution:

Visit an OMNIplus Service Partner.

- ▶ Secure the position of adjustment screw (1.2) using lock nut (1.4)
- ▶ Secure the tensioning lever mounting to the carrier using securing screws (1.1).

Tyres - operating safety and roadworthiness

Tyres are particularly important for the operating safety and roadworthiness of the bus.



Note:

The pressure, tread and condition of the tyres should therefore be checked on a regular basis.



Caution:

The use of wheel balancing agents, such as balancing powder, beads or gel, is not permitted as these may lead to undesirable pulsations and/or vibrations.

Tyre pressure

Check the specified tyre pressure regularly – at least once a week and before longer journeys – when the tyres are cold.



Danger.

Always observe the specified tyre pressures for your bus. The temperature and pressure of the tyres increase when the bus is in motion. For this reason, you should never reduce the pressure of warm tyres. The tyre pressures would then be too low once the tyres had cooled. If the tyre air pressure is too low, the tyre is liable to burst, particularly with increasing numbers of passengers/load and speed. This could result in you losing control of your bus and causing an accident, thereby injuring yourself and other people.



Note:

If the tyre pressure is too low, this leads to intensive heating of the tyres, increased tyre wear, changes in directional stability and increased fuel consumption.



Note:

If the tyre pressure is too high, this results in a longer braking distance, poorer tyre grip and increased tyre wear.



Caution:

Caps on the tyre inflation valves protect the valve inserts from moisture and dirt. The caps on the tyre inflation valves should therefore always be screwed on tightly.

Tyre tread

Tyre tread

A minimum tyre tread depth is specified by law. Comply with the legal specifications for the relevant country.

As the remaining tread depth reduces, the less effective the road grip and handling characteristics of the bus become, particularly on wet or snowy roads.

In the interest of safety, have the tyres replaced before the legally-specified minimum tread depth is reached.

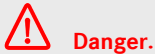

Danger.

Always ensure that there is sufficient tyre tread. Insufficient tyre tread depth increases the risk of aquaplaning if the bus is driven at high speed during heavy rain or in slush. The tyre tread can no longer deflect the water away. This could result in you losing control of your bus and causing an accident, thereby injuring yourself and other people.

Tyre condition

Before setting off, check the tyres on the bus for:

- external signs of damage
- foreign objects in the tyre tread
- foreign objects between twin tyres
- cracks, bulges

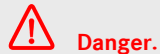

Danger.

Please note that cracks, bulges or external damage can cause a tyre to burst. This could result in you losing control of the bus and causing an accident, thereby injuring yourself and other people. Have damaged tyres replaced with new ones immediately.

Tyre age

Have the tyres changed at least every six years, irrespective of wear. This also applies for the spare wheel.



Danger.

The sun's rays and environmental factors cause tyres to age. The rubber from which the tyre is made loses elasticity. Tyres harden and become brittle, cracks appear due to ageing. Tyres which are more than six years old are no longer reliable.

Invisible tyre damage

Avoid crushing tyres against the kerb or switching off the bus when a part of the tyre tread is up on the kerb.

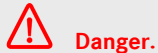
**Danger.**

Driving over the edge of the kerb or sharp edged objects can cause damage to the tyre substructure which is not visible externally. Damage to the tyre substructure only becomes noticeable much later and could cause the tyre to burst. This could result in you losing control of your bus and causing an accident, thereby injuring yourself and other people.

Tyre load capacity, top speed of tyres and types of tyres**Danger.**

Exceeding the specified tyre load capacity or the approved maximum tyre speed could lead to tyre damage or tyre failure. You could then lose control of your bus and cause an accident, which could result in injury to yourself and others. For this reason, use only the tyre types and sizes approved for your bus model and observe the required tyre load capacity and speed index for your bus. Pay particular attention to country-specific tyre approval regulations. These regulations may specify a particular type of tyre for your bus or prohibit the use of particular tyre types that may be approved in other countries. In addition, it may be advisable to use a specific type of tyre in certain regions or areas of use. You can obtain information on tyres from any OMNIplus Service Partner.

Where twin tyres are fitted, the twin tyres must have the same external dia-

meter, otherwise the tyre that has the largest diameter will be overloaded. Tip: The simplest and most reliable measurement method is to check circumferences using a circumference tape.

**Note:**

The maximum tolerance for twin tyres is 0.5% of the tyre diameter. The larger tyre must always be fitted in the outboard position.

















Retreaded tyres

Retreaded tyres

It is advisable to use only tyres and wheels that EvoBus has tested and approved specifically for your vehicle.

Tyre pressures table 275/70 R 22.5

Tyre pressures table 275/70 R 22.5

		[bar]	6,0	6,5	6,75	7,0	7,25	7,5	7,75	8,0	8,25	8,5	8,75	9,0
275 / 70 R 22.5 148 / 145	Continental		--	5085	--	5395	--	5700	--	6000	--	6300	--	--
			--	9360	--	9930	--	10495	--	11050	--	11600	--	--
	Michelin*		--	--	--	--	--	5010	5330	5650	5820	5980	--	6300
			--	--	--	--	--	9720	10350	10970	11290	11600	--	--
	Fulda		--	--	--	5150	5300	5440	5590	5730	5880	6020	6160	6300
			--	--	--	9490	9760	10030	10290	10560	10820	11080	11340	11600
	Goodyear		--	--	--	--	5300	5440	5590	5730	5880	6020	6160	6300
			--	--	--	--	9760	10030	10290	10560	10820	11080	11340	11600
	Dunlop		--	4860	5000	5150	5300	5440	5590	5730	5880	6020	6160	6300
			--	8940	9220	9480	9760	10020	10300	10560	10820	11080	11340	11600
	Bridgestone		--	5000	5140	5280	5420	5540	5670	5800	5930	6050	6180	6300
			--	9360	9610	9860	10120	10370	10620	10870	11050	11200	--	--
														
														
														
														

* For Michelin tyres, also note: the tyre pressures at the front axle must be adjusted in accordance with the table value plus 1 bar, but to no more than a maximum of 8.5 bar.

**Note:**

The numbers in the table show the respective axle load in kg. The table's first line gives the tyre pressure that is to be set in bar.

**Note:**

The tyre pressures table shown here cannot be considered complete and is primarily provided for guidance only. The tyre catalogue of the manufacturer concerned is the decisive point of reference for the precise tyre pressures to be set in accordance with the current axle load.

Tyre pressures table 11 R 22.5

Tyre pressures table 11 R 22.5

		[bar]	6,0	6,5	6,75	7,0	7,25	7,5	7,75	8,0	8,25	8,5	8,75	9,0
11 R 22,5 148 / 145	Continental		--	5335	--	5660	--	5985	--	6300	--	--	--	--
			--	9825	--	10425	--	11015	--	11600	--	--	--	--
	Michelin*		--	5220	--	5580	--	5940	6120	6300	--	--	--	--
			--	9610	--	10270	--	10940	11270	11600	--	--	--	--
	Fulda		--	5080	5240	5390	5550	5700	5850	6000	6150	6300	--	--
			--	9360	9650	9930	10210	10450	10770	11050	11330	11600	--	--
	Goodyear		--	5080	5240	5390	5550	5700	5850	6000	6150	6300	--	--
			--	9360	9650	9930	10210	10450	10770	11050	11330	11600	--	--
	Dunlop		--	5080	5240	5390	5550	5700	5850	6000	6150	6300	--	--
			--	9360	9640	9940	10220	10500	10780	11060	11320	11600	--	--
	Bridgestone		--	5080	5230	5390	5540	5700	5850	6000	6150	6300	--	--
			--	9510	9780	10040	10300	10540	10800	11080	11340	11600	--	--

* For Michelin tyres, also note: the tyre pressures at the front axle must be adjusted in accordance with the table value plus 1 bar, but to no more than a maximum of 8.5 bar.

**Note:**















The numbers in the table show the respective axle load in kg. The table's first line gives the tyre pressure that is to be set in bar.

**Note:**

The tyre pressures table shown here cannot be considered complete and is primarily provided for guidance only. The tyre catalogue of the manufacturer concerned is the decisive point of reference for the precise tyre pressures to be set in accordance with the current axle load.

Tyre pressures table 295/80 R 22.5

Tyre pressures table 295/80 R 22.5

		[bar]	6,0	6,5	6,75	7,0	7,25	7,5	7,75	8,0	8,25	8,5	8,75	9,0
295 / 80 R 22.5	Michelin		5180	5560	5760	5950	6140	6330	6520	6720	6910	7100	--	--
			9190	9880	10220	10560	10900	11240	11580	11920	12260	12600	--	--
	Continental		5370	5725	--	6075	--	6420	--	6760	--	7100	--	--
			9535	10165	--	10785	--	11395	--	12000	--	12600	--	--
	Dunlop		5380	5730	5910	6080	6260	6430	6600	6770	6940	7100	--	--
			9540	10170	10480	10790	11100	11400	11710	12010	12310	12600	--	--
	Goodyear		5380	5730	5910	6080	6260	6430	6600	6770	6940	7100	--	--
			9540	10170	10480	10790	11100	11400	11710	12010	12310	12600	--	--
	Bridgestone		5370	5720	5900	6070	6250	6420	6590	6760	6930	7100	--	--
			9530	10160	10470	10780	11090	11390	11700	12000	12300	12600	--	--
	Firestone		5370	5720	5900	6070	6250	6420	6590	6760	6930	7100	--	--
			9530	10160	10470	10780	11090	11390	11700	12000	12300	12600	--	--
	Pirelli		--	5730	5900	6080	6250	6420	6590	6760	6930	7100	--	--
			--	10170	10480	10790	11090	11400	11700	12000	12300	12600	--	--

M40.00-0122-01

Safety measures to be taken in the event of a flat tyre or a wheel change

The numbers in the table show the respective axle load in kg. The table's first line gives the tyre pressure that is to be set in bar.

*

For Michelin tyres, also note: the tyre pressures at the front axle must be adjusted in accordance with the table value plus 1 bar, but to no more than a maximum of 8.5 bar.



Note:

The tyre pressures table shown here cannot be considered complete and is primarily provided for guidance only. The tyre catalogue of the manufacturer concerned is the decisive point of reference for the precise tyre pressures to be set in accordance with the current axle load.

Safety measures to be taken in the event of a flat tyre or a wheel change



Danger.

Park the bus on firm ground as far as possible from moving traffic. Switch on the hazard warning lamps. Urge all passengers to disembark and direct them to a place of safety (e.g. behind the crash barrier). Position a warning triangle or hazard warning light at a suitable distance. Observe the legal requirements of the country concerned.

- ▶ Carry out the wheel change only on a level, firm and non-slip surface. The bus or jack may slip out to the side on a soft or slippery surface (snow, ice, smooth surface, etc.).



Danger.

Never lie under the bus if it has been raised without the additional support of axle stands. Do not start the engine as there is a risk of fatal injury. Prevent the engine from being switched on without authorisation. Remove the key from the ignition starter switch.

Positioning the jack

Positioning the jack



Danger.

Observe the operating instructions issued by the jack manufacturer.



Danger.

Secure the bus against rolling away (apply the parking brake). Also chock at least one front wheel if there is a defective wheel on the rear axle.



Danger.

Risk of entrapment. If support stands are not available, the spare wheel or the defective wheel must be placed under the body at a suitable position for the duration of the tyre change to provide protection in case the jack should fail.

Front axle

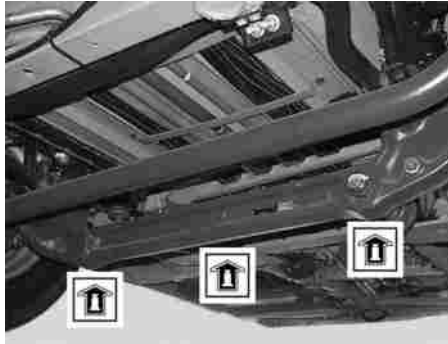

M00_00-0088-01

- ▶ Place the telescopic jack (10 t) on a laminated wood base and jack up the bus from under the axle beam on the left- or right-hand side.

Driven axle

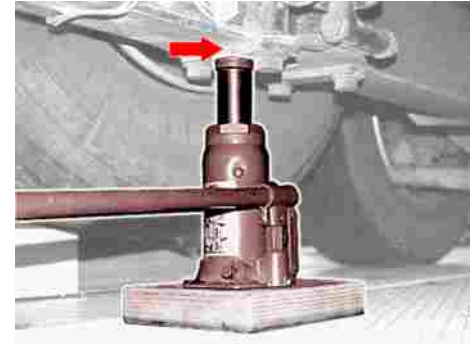

M40_00-0013-01

- ▶ Place the telescopic jack (10 t) on a laminated wood base and jack up the bus at the jacking point (arrowed).

Removing the wheel trims

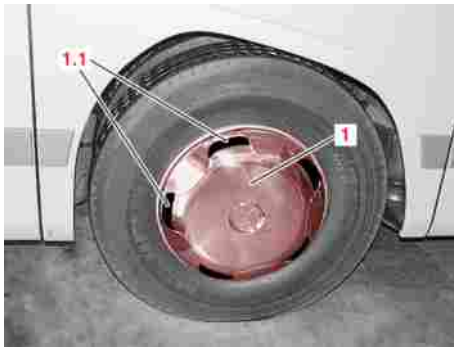

M40_00-0007-01

- Reach into ventilation openings (1.1) in wheel trims (1) with both hands.

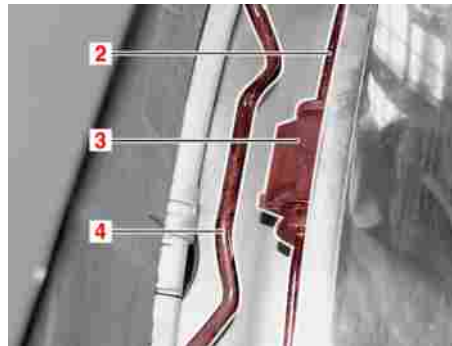

M40_00-0008-01

- First, detach clamp ring (2) from retaining clip (3). This reduces the compression force on clamp ring (4) and the wheel trim can be removed more easily.

Fitting a wheel nut cover cap

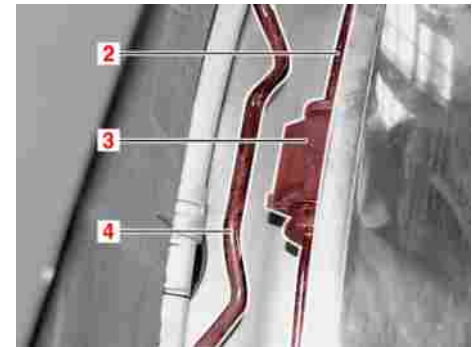

M40_00-0008-01

- Place the wheel trim on clamp ring (4). At the same time, insert the tabs of retaining clips (3) on the wheel trim into the cut-out in clamp ring (4). Attach the lower retaining clips and press on. Then press the wheel trim into the other retaining clips.

Fitting a wheel nut cover cap

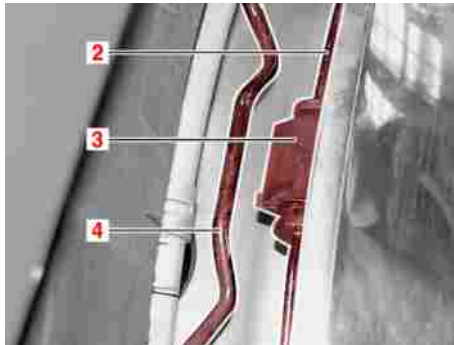

M40_00-0008-01

- ▶ Press last of upper retaining clips (3) in with clamp ring (2) detached. This greatly reduces the amount of effort required and you also avoid the risk of causing damage to the wheel trim. After you have fitted the wheel trim, reach into the ventilation openings and hook clamp ring (2) into retaining clip (3) again. The retaining clips must not rest on a balance weight.



Danger.

Make sure that the wheel trim is seated correctly. All retaining clips (3) must be fastened behind clamp ring (4).



Note:

Where necessary, remove rust and dirt from the contact surfaces on the wheel nut cover, disc wheel and wheel nuts before the wheel nut cover is fitted.



M40_00-0131-01

- ▶ Slot wheel nut cover (1) onto the wheel bolts.



Caution:

To fit the wheel nut cover correctly, 4 wheel nuts must be fastened by hand to centre the wheel nut cover and bring it into full contact with the disc wheel.

- ▶ Tighten the wheel nuts to the specified torque in a crosswise pattern and in several stages.

Tightening torque

Wheel nuts for aluminium wheels:
600 Nm

Removing a wheel

Preparations

- ▶ Removing the wheel trims
(▷ Page 189)
- ▶ Loosen all wheel nuts
- ▶ Raising the bus



Danger.

Risk of accident. Due to rolling away, slipping, dropping or tilting of the bus. Do not raise the bus unless it is parked on even and stable ground. Before raising the bus, chock the wheels to prevent the bus from rolling away. Once the bus has been raised, it is necessary to provide support for the axles or body. To raise and secure the bus, use only equipment and tools that meet legal requirements (observe country-specific regulations) and have an appropriate load-bearing capacity for the axle or bus weights concerned.



Danger.

If the complete bus is to be raised using wheel grippers, multi-post lifts, etc., all axles must be raised simultaneously.



Caution:

When the bus is being lowered, make sure that the suspension air bags are seated correctly and that there is sufficient supply pressure to fill the suspension air bags again.

- ▶ Unscrew all the wheel nuts and remove the wheel(s).



Caution:

To avoid causing damage to the wheel bolt threads, lift the wheel slightly as you remove it from the wheel hub. Damaged wheel bolt threads make it difficult to screw on the wheel nuts at the fitting stage and, if the damage is severe, the wheel nuts could become seized on the bolts.

Fitting wheels

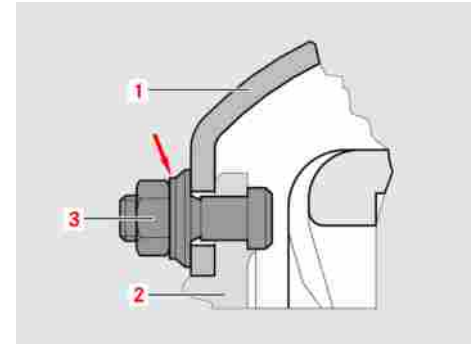

M40_00-0016-01

- ▶ Coat the outside of the centring lugs on hub (2) with Plastilube anticorrosion paste to prevent the disc wheels (rims) from rusting.



Danger.

The thread of the wheel bolts and wheel nuts must be free of oil and grease. Degrease the thread if necessary.

- ▶ Fit the spare wheel

Fitting wheels



Danger.

If aluminium wheels are to replace pressed-steel wheels, be sure to use the correct wheel nuts. In the case of older buses equipped with aluminium wheels (wheel nuts bearing the marking: “Für Alu-Räder” (for aluminium wheels)), only aluminium disc wheels having a wheel bolt hole diameter of 28 mm are permitted in the event of a wheel change.



Note:

Disc wheels (1) are centred by the centring lugs on hub (2).

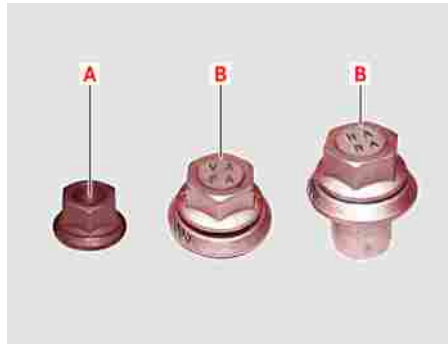

M40_00-0053-01

- ▶ Fit the wheel nuts and screw them on into contact with the wheel.



Danger.

Note the different flat collar nuts. A: Wheel nuts for pressed-steel wheels (steel rims) do not have any marking, B: Wheel nuts for aluminium wheels (aluminium rims) bear the inscription “VA FA” for single tyres, “HA RA” for twin tyres and a marking with 3 rings on the integral thrust washer (see illustration).



Danger.

Always select the correct nuts for the type of wheel concerned.



M40_00-0061-01

- ▶ For vehicles with light-alloy wheels (aluminium rims), slide the assembly sleeves (vehicle tool kit) over 2 opposing wheel bolts to avoid damage during removal and refitting.
- ▶ Place the ramp back under the wheel, lower the bus and take the jack away.

Inflating tyres using the tyre inflator connection



Note:

If you do not push the ramp under the wheel, it will not be possible to remove the jack.

- ▶ Tighten the wheel nuts in a crosswise pattern

Tightening torque

Wheel nuts: 600 Nm



Danger.

Tighten the wheel nuts using the available tool and drive cautiously to the nearest OMNIplus Service Partner. Have the wheel nuts tightened to the specified torque.



Danger.

If you use an impact wrench, tighten the wheel nuts only slightly in a crosswise pattern first and then tighten the nuts to the specified torque using a torque wrench.

- ▶ Drive the bus off the ramp



Danger.

The wheel nuts must be retightened after the bus has covered 50 km.



Danger.

If a new or newly painted wheel has been fitted, retighten the wheel nuts again after the bus has covered a distance of approximately 1,000 to 5,000 km.

Inflating tyres using the tyre inflator connection



Note:

While the engine is running, a pressure of up to 12 bar (cut-out pressure of the pressure regulator) can be drawn off. Compressed air cannot be drawn off unless the pressure regulator is in the fill position. If the pressure regulator has cut out (idle position - blows into the open air), it will be necessary to reduce the pressure using the pedal-operated brake valve until the pressure regulator cuts in again.



Caution:

Since the pressure in the system may be too high for inflating a tyre, the inflation procedure should be monitored by observing the pressure readings on the instrument display panel.

Practical advice

Inflating tyres using the tyre inflator connection



M42_00-0609-71

- ▶ Remove the protective cap from the tyre inflator connection (arrowed) on the air drier unit and connect the tyre inflation hose.



Note:

The tyre inflation hose is in the vehicle tool kit.



M54.00-1863-71

- ▶ Reduce the pressure in the compressed-air system (by pumping the brake pedal) until the supply pressure reading for circuits 1 (1) and 2 (2) shown on pressure gauge (3) drops below 6.5 - 7 bar.

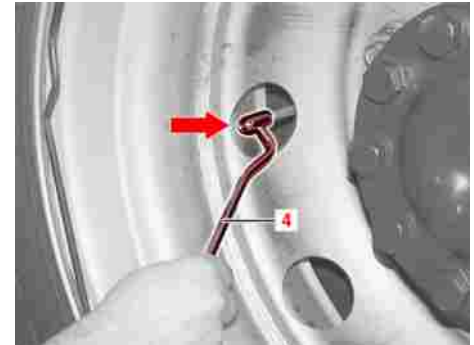

M40_00-0020-01

- ▶ Unscrew the protective cap from the tyre valve and connect valve connector (4).

Inflating tyres using the tyre inflator connection



M54.00-1863-71

- ▶ Start the engine and inflate the tyres to the specified pressure (approximately 8.5 bar). First remove valve connector (4) from the tyre valve, then switch off the engine.



Note:

Monitor the operating display for the supply pressure in circuits 1 (1) and 2 (2).



M42_00-0609-71

- ▶ After you have finished inflating the tyres, remove the tyre inflation hose and seal the tyre inflator connection (arrowed) with the protective cap.



Danger.

Never drive the bus with the tyre inflation hose still connected.



Danger.

Inflate the tyres to the specified pressure at the earliest opportunity.

Pneumatic test ports

Pneumatic test ports



Charging the compressed-air system (option)

The pneumatic test ports for the brake system are normally located on the left-hand side to the front of the front axle (on the right-hand side on right-hand-drive vehicles). The body manufacturer is responsible for the exact location of, and access to, the test ports.

- 1 *Pressure regulator switching pressure*
- 2 *Driven axle supply pressure*
- 3 *Front axle supply pressure*
- 4 *Auxiliary consumers supply pressure*
- 5 *Brake pressure on driven axle, downstream of ABS*
- 6 *Brake pressure on right-hand side of front axle, downstream of ABS*
- 7 *Brake pressure on left-hand side of front axle, downstream of ABS*
- 8 *Spring cylinder supply pressure*

- 9 *Spring cylinder emergency release pressure*
- 10 *Spring cylinder pressure/release pressure*
- 11 *Not assigned*
- 12 *Not assigned*
- 13 *Not assigned*
- 14 *Not assigned*

Charging the compressed-air system (option)



M40_00-0041-01

- Front port: the bus can be charged with compressed air.

Checking the oil level in the steering hydraulics expansion tank

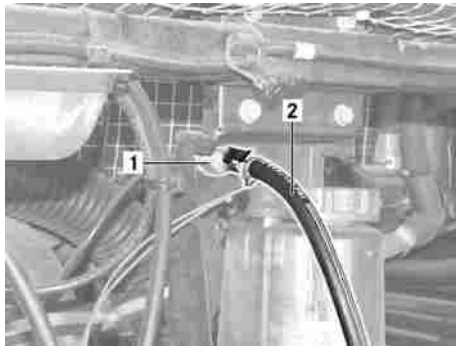

M40_00-0034-01

- ▶ Rear port: the bus can be charged with compressed air.

Checking the oil level in the steering hydraulics expansion tank



M46_00-0032-01

- ▶ Read the oil level.

i Note:

The oil level must be seen to be between the minimum and maximum mark (2) on expansion tank (1) when the engine is running.

i Note:

In buses with electronic oil level detection (option), it is possible to call up the oil level on the display screen using the control rocker switch.

! Danger.

Power-steering oil must be topped up only by an authorised specialist and in accordance with the Specifications for Service Products.

Replacing the fuel filter for the auxiliary heater (option)

Replacing the fuel filter for the auxiliary heater (option)



Danger.

Risk of explosion from ignition of fuel, risk of poisoning from inhalation and swallowing of fuel as well as risk of injury if fuel comes into contact with skin and eyes.



Danger.

Make sure that the auxiliary heater cannot be switched on.

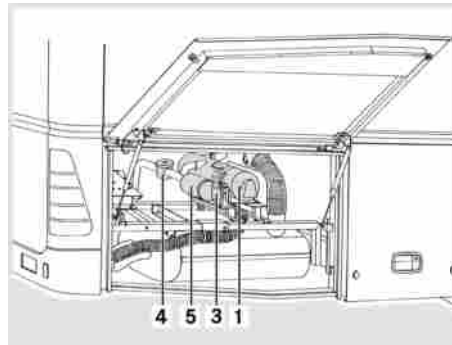

M83_00-0242-01

- ▶ Fuel filter (3) is located in the engine compartment at the rear right.

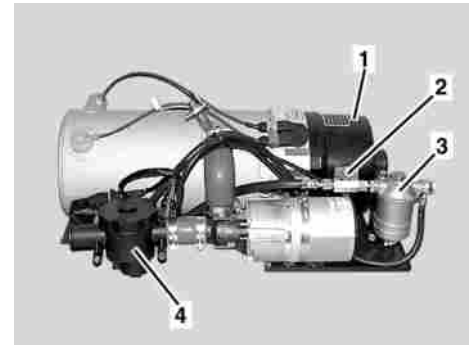

M83_00-0142-01

- ▶ Close fuel feed shut-off valve (2).



Note:

This prevents fuel from running out of the tank when the fuel filter is open.

- ▶ Place a suitable receptacle under the fuel filter.

Replacing the fuel filter for the auxiliary heater (option)

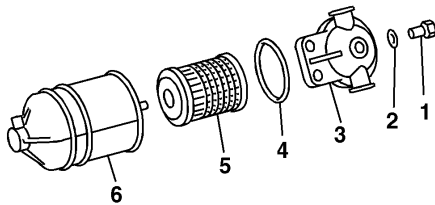

M83_00-0023-01

- ▶ Unscrew screw (1) with seal (2) from filter head (3) and remove filter housing (6) along with filter element (5).
- ▶ Pull filter element (5) out of filter housing (6).



Environmental protection

Dispose of drained fuel and old filter element (5) in accordance with the rules and regulations in force in the area of vehicle operation.

- ▶ Drain and clean filter housing (6).
- ▶ Open shut-off valve (2).

- ▶ Replace sealing ring (4) on filter housing (3) with a new one.
- ▶ Insert new filter element (5) into filter housing (6) and fill the filter housing with diesel fuel.
- ▶ Secure filter housing (6) and new sealing ring (2) to filter head (3) using screw (1).

Tightening torque

Auxiliary heater: filter housing to filter head: 10 Nm

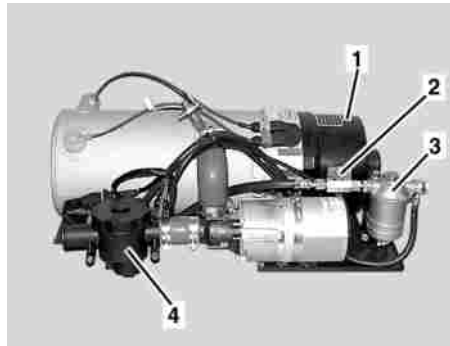

M83_00-0142-01

- ▶ Start the auxiliary heater and check the fuel filter for leaks.



Note:

For notes on safety and operation, refer to the "Safety" section



Danger.

Risk of injury. Any necessary retightening must be carried out with the engine switched off.

Electrical system safety precautions

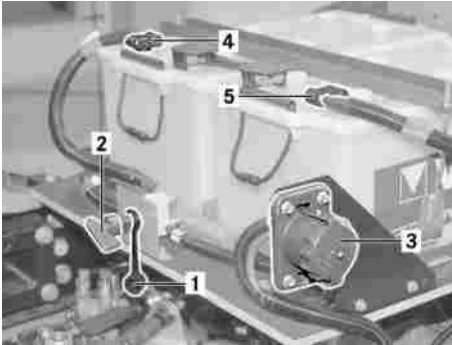

M54_00-0806-01

The control panels and batteries are delivered preassembled and precabled, but without a precisely defined installation location on the chassis. The body manufacturer is responsible for the exact installation location and for providing access to it.

For safety reasons, observe the following safety precautions before work is carried out on the electrical system or the batteries are disconnected/reconnected: Always switch off battery isolating switch (2).

Do not connect or disconnect wiring harness connectors to/from electronic control units unless the ignition starter switch is OFF.

During engine washes, always protect the starter, alternator and electrical plug connections from moisture.

Never attempt to bridge or repair fuses.

Use only fuses of the specified amperage. Never replace fuses with those of a higher ampere rating as this could lead to damage to the electrical system.

Safety precautions for handling batteries



M54_10-0004-01

(1) - Fire, sparks, naked flames and smoking are prohibited. Prevent sparking.

(2) - Risk of explosion.

(3) - Observe the operating instructions.

(4) - Risk of acid burns. Battery acid is corrosive. Always observe the safety instructions and safety precautions when handling batteries or battery acid. Battery acid must never come into contact with skin, eyes or clothing. Rinse off all acid splashes immediately with copious

Measures required for the prevention of damage to buses or components during electric welding work

amounts of clean water. Seek medical attention if necessary.

(5) - Wear safety goggles.

(6) - Keep children away.



Danger.

Naked flames and smoking are strictly prohibited whenever work is being carried out on the vehicle batteries. Avoid the creation of sparks. Wear safety goggles. Keep children away. There is a risk of acid burns. The Operating Instructions must be observed. There may be a risk of explosion.



Danger.

Only lead-acid batteries are permitted to be fitted, never gel batteries. All cells of the batteries must be fitted with special caps that are interlinked by vent hoses, thereby allowing any gases produced to be directed into the open air.



Danger.

Risk of short circuit. Do not place any metal objects on batteries.



Caution:

Do not loosen or disconnect the terminal clamps while the engine is running and electrical consumers are switched on.



Environmental protection

Dispose of defective batteries in an environmentally responsible manner. Observe legal requirements.

Measures required for the prevention of damage to buses or components during electric welding work

To prevent damage to various components of the bus, the following measures must be taken before welding work is carried out:

- Have a fire extinguisher on standby.
- The clip on the negative terminal of the battery must be disconnected and the negative terminal covered. (Observe the notes on disconnecting the vehicle batteries.)
- The pieces of foam fitted in some of the cavities in the body as sound-proofing must be removed before the commencement of panel work, welding and tin-plating.
- Connect the earth connection of the electric welder directly to the part to be welded. When doing so, make sure that there are no electrically insulating parts between the earth connection and the weld point.

Measures required for the prevention of damage to buses or components during electric welding work

- Heat-sensitive parts, such as plastic tubes, are to be protected or removed.
- Lines routed in cavities, and containers or electronic components that have been fitted concealed, must be removed from the danger area before the start of welding.
- The passenger compartment and glazing must be covered with protective mats as protection against weld splatter and flying sparks.
- Shield off areas at risk of damage caused by flying sparks and radiant heat.
- Do not allow electronics housings or electrical lines to come into contact with the welding electrode or the earth connection of the welder.
- If two parts are to be welded together, both parts must be connected to the negative clip of the welder.
- The seam points of the part on the bus to be welded and of the earth terminal on the electric welder must be as bare as possible. Thoroughly remove paint, corrosion, oil, grease and dirt.
- The earth terminal of the welder must not be connected to the transmission. The welding current may cause sparking at the bearing points inside the transmission. The resultant changes in crystalline structure would lead to premature failure of the assembly.



Danger.

The heating effects may cause dense smoke or fires.

Fuse assignment for driver's area switch panel

Fuse assignment for driver's area switch panel

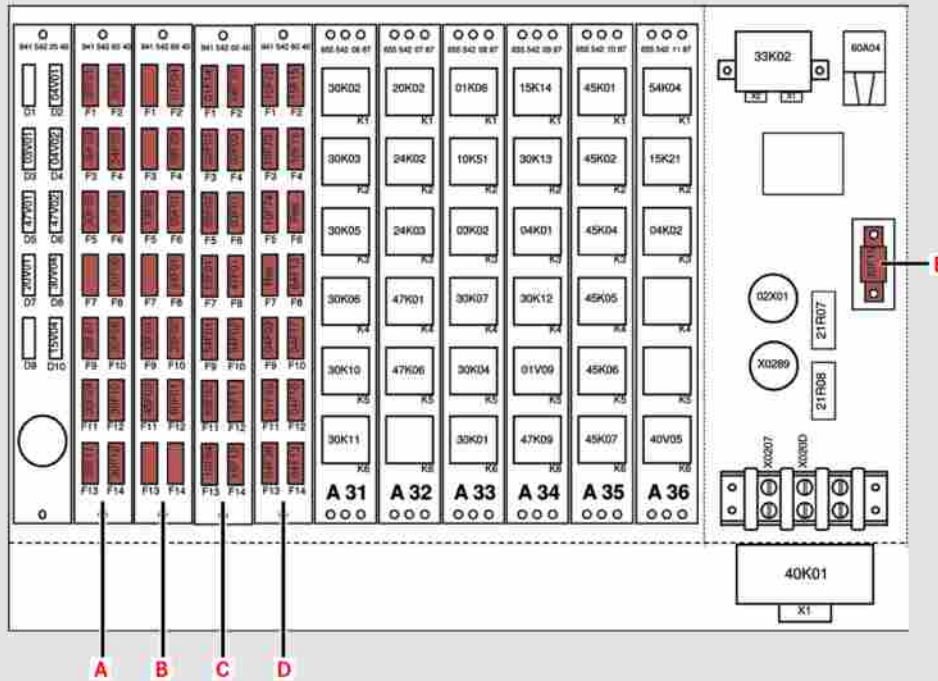

Fuse assignment for driver's area switch panel



Note:

The body manufacturer is responsible for the installation locations of the switch panels.

Fuse block A

- F1 10 A - Hazard warning lamps terminal 15 (30F01)
- F2 10 A - Hazard warning lamps terminal 30 (30F02)
- F3 10 A - Front foglamps (30F03)
- F4 15 A - Heater for heating-oil filter (54F05)
- F5 5 A - Clearance lamp, left (30F05)
- F6 5 A - Clearance lamp, right (30F04)
- F7 Not assigned
- F8 5 A - Fuse terminal 58 (30F06)
- F9 5 A - Dipped-beam headlamp, left (30F07)
- F10 5 A - Dipped-beam headlamp, right (30F08)

- F11 7.5 A - Main-beam headlamp, left (30F09)
 - F12 7.5 A - Main-beam headlamp, right (30F10)
 - F13 7.5 A - Brake lamps (30F11)
 - F14 5 A - Reversing lamps (30F12)
- Fuse block B
- F1 Not assigned
 - F2 7.5 A - Fuse terminal D+ (01F04)
 - F3 Not assigned
 - F4 5 A - Sensing terminal 15R (08F29)
 - F5 7.5 A - DNR pushbutton (13F02)
 - F6 7.5 A - Diagnostics socket (05F01)
 - F7 Not assigned
 - F8 15 A - Compressed-air supply (24F01)
 - F9 5 A - Horn (33F01)
 - F10 20 A - Wiper (33F02)
 - F11 7.5 A - Ramp (45F02)
 - F12 7.5 A - C3 signal I-module/satellite (60F01)

- F13 Not assigned
 - F14 Not assigned
- Fuse block C
- F1 15 A - Ignition lock (01F14)
 - F2 5 A - Sensing terminal 50 (08F30)
 - F3 7.5 A - Socket for auxiliary switch panel/engine compartment lighting (02F01)
 - F4 7.5 A - Socket for electrical equipment compartment/instrument panel/electronic loudspeaker system (02F02)
 - F5 7.5 A - Diagnostics socket terminal 30 (05F02)
 - F6 15 A - Master safety switch (03F01)
 - F7 15 A - Automatic transmission (13F01)
 - F8 5 A - Bus stop brake (47F01)
 - F9 20 A - Auxiliary heating (54F01)
 - F10 20 A - Auxiliary heating (54F02)

Fuse assignment for driver's area switch panel

F11 7.5 A - Satellite terminal 30/
instrument nodes supply
(60F02)

F12 5 A - Fuel shut-off valve ter-
minal 30 (15F11)

F13 15 A - Heating for fuel filter
(10F64)

F14 5 A - Fuel shut-off valve ter-
minal 15 (15F12)

Fuse block D

F1 7.5 A - Drive train terminal 15
(10F72)

F2 20 A - Fuel pump (15F15)

F3 15 A - Terminal 15 power sup-
ply for powertrain control units
(10F73)

F4 20 A - Drive control CPC ter-
minal 30 (10F75)

F5 7.5 A - Drive train terminal 15
(10F74)

F6 Not assigned

F7 Not assigned

F8 7.5 A - Fire detection sys-
tem/fire extinguishing system
(64F13)

F9 5 A - FPS 2 (04F02)

F10 5 A - FPS terminal 15 (04F17)

F11 7.5 A - Alternators terminal 15
(01F55)

F12 5 A - FPS 2 (04F10)

F13 5 A - FPS failure indicator
lamp (04F38)

F14 5 A - FPS 5 (04F13)

Fuse block E



Note:

This description is based on the standard assignment of fuses in the bus. Bus-specific assignment may differ from bus to bus. Not all fuse slots are necessarily occupied in every bus. Furthermore, fuses may occupy unassigned slots because they are protecting special customer options or retrofitted equipment, for example.



Note:

The bus-specific fuse assign-
ment and fuse ratings can be
found on the vehicle data CD
located in the driver's area
switch panel.

30F15

30 A - Light switch

Practical advice

Fuse assignment (main fuses) for auxiliary switch panel

Fuse assignment (main fuses) for auxiliary switch panel

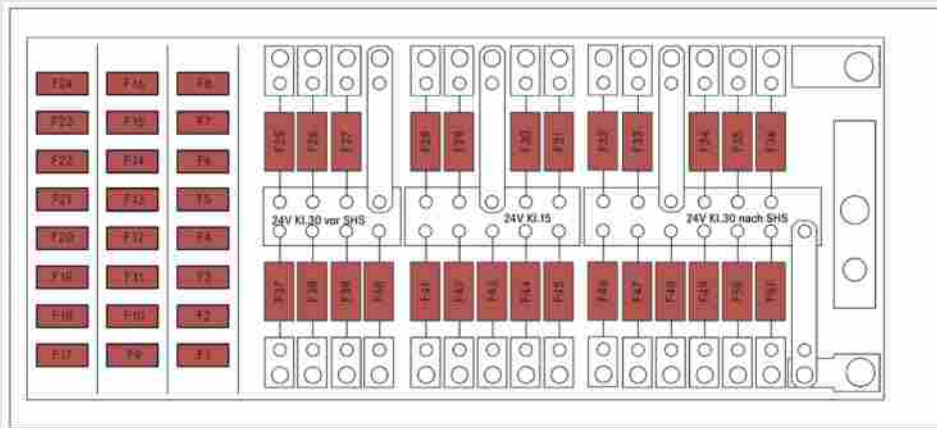

Fuse assignment (main fuses) for auxiliary switch panel

F1	15 A - Automated manual transmission terminal 30 (12F04)	F47	100 A - Main fuse terminal 30 (01F07)
F2	15 A - Automated manual transmission terminal 30 (12F05)	F48	30 A - IES terminal 30 (01F05)
F3	15 A - AdBlue® supply unit terminal 30 (17F08)	F49	30 A - Engine management MCM terminal 30 (10F51)
F4	5 A - Trailing axle terminal 30 (22F05)	F50	Not assigned
F5	7.5 A - Retarder terminal 30 (14F03)	F51	30 A - Exhaust gas aftertreatment control module ACM terminal 30 (17F11)
F6-F12	Not assigned		
F13	5 A - Trailing axle terminal 15 (22F06)		
F14-F16	Not assigned		
F17	7.5 A - Tachograph/instrument node (60F03)		
F18-F39	Not assigned		
F40	50 A - Main fuse terminal 30 (01F13)		
F41-F44	Not assigned		
F45	30 A - IES terminal 15 (01F06)		
F46	100 A - Main fuse terminal 15 (01F02)		



Note:

The bus-specific fuse assignment and fuse ratings can be found on the vehicle data CD located in the driver's area switch panel.



Note:

This description is based on the standard assignment of fuses in the bus. Bus-specific assignment may differ from bus to bus. Not all fuse slots are necessarily occupied in every bus. Furthermore, fuses may occupy unassigned slots because they are protecting special customer options or retrofitted equipment, for example.

Handling fuses

Handling fuses

- ▶ Always carry some spare fuses in the bus for emergencies.



Caution:

Fuses provide protection against excessive current loads (impermissible heating of the wires) in the electrical system. The body manufacturer is responsible for the installation locations of the switch panels. The fuse assignment (chassis components) is bus-specific. The legend is printed on the adhesive label affixed near the switch panels (only if fitted by the body manufacturer).

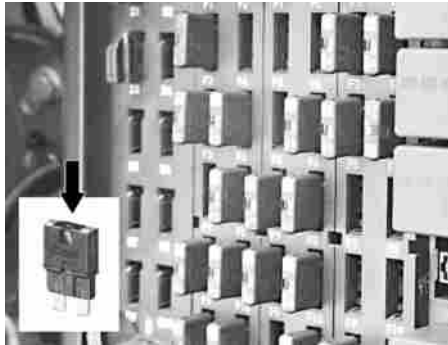

M54_00-0878-01

- ▶ Miniature circuit breakers (option) can be reset by pressing the contact pin in (arrowed).
- ▶ The following instructions and information must be observed.



Danger.

Make sure that you correct the cause of the short circuit before you change a blown fuse. Make sure that connections have good contact.



Danger.

Never attempt to bridge or repair fuses.



Danger.

Use only fuses of the specified amperage. Never replace fuses with those of a higher ampere rating as this could lead to damage to the electrical system.



Danger.

Always switch the battery isolating switch to OFF before work is carried out on the electrical system.

Disconnecting vehicle batteries

Disconnecting vehicle batteries

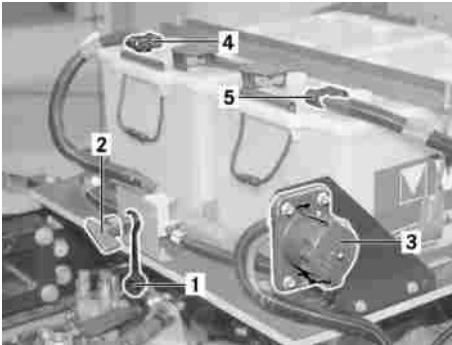

M54_00-0806-01

- ▶ Switch off the engine.

i Note:

The body manufacturer is responsible for the installation location of the batteries and for providing access to them.

- ▶ Switch off the battery isolating switch (2).

! Danger.

There is a risk of explosion from the ignition of oxyhydrogen gas by separation sparks at the time of battery disconnection. Battery isolating switch (2) is fitted to rule out this risk of injury.

! Danger.

Switch battery isolating switch (2) to the OFF position (key can be removed) before working on parts of the vehicle electrical system, especially the batteries. The battery isolating switch interrupts the main line from the positive terminal of the battery to the entire vehicle electrical system; for this reason, it must not be switched off until the ignition starter switch has been switched to OFF and the auxiliary heater's run-on period has ended (risk of overheating).

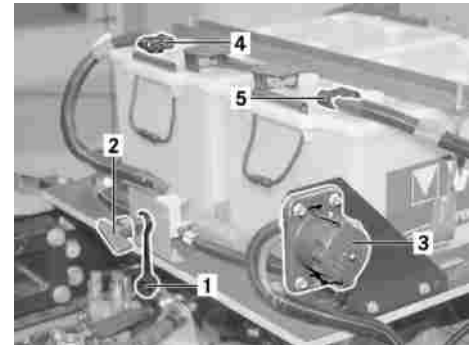

M54_00-0806-01

- ▶ Disconnect the battery negative terminal clamp (5).

i Note:

The illustration shows a possible example. The body manufacturer is responsible for the installation location of the batteries.

- ▶ Disconnect the battery positive terminal clamp (4).
- ▶ Reconnect the batteries in reverse order.

Recharging vehicle batteries

Recharging vehicle batteries



Note:

Recharge out-of-service batteries once a month.

- ▶ Connect the charger.



Danger.

Risk of explosion from oxyhydrogen gas formation. Make sure that the area is well-ventilated when you are recharging the vehicle batteries.



Note:

Check that the charging voltage (24 or 12 V) and charging current (approximately 1/10 of the rated capacity, e.g. 200 Ah battery with 20 A charging current) are correct.

- ▶ Switch off the charger after charging has finished.



Danger.

Do not disconnect the connection terminals until the gases have stopped escaping from the battery (wait a few minutes).

Notes on jump-starting

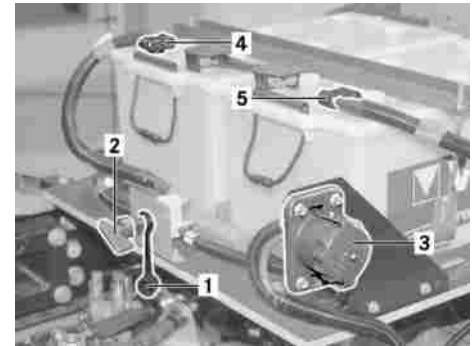

M54_00-0806-01

- ▶ Where possible, use jump-start connection (3) for the jump-starting procedure.
- ▶ If the jump-start procedure is not carried out using the jump-start connection: the following instructions and information must be observed.



Caution:

Before you connect the jump leads, check that the operating voltage (24 V) and polarity are the same.



Caution:

Only jump leads (cable cross-section approximately 70 mm²) are permitted to be used as a starting aid – never use a rapid charger. Comply with the safety regulations.



Caution:

Use only jump leads that have insulated terminal clips.



Note:

A discharged battery can freeze at temperatures below -10°C. A frozen battery must be thawed out before the jump-start operation.



Danger.

Risk of acid burns. Do not lean over the battery during the jump-start procedure.

Jump-start procedure

- ▶ Turn the key back to the stop in the ignition starter switch.



M54_00-0806-01

- ▶ Connect one end of the positive cable to the (+) terminal of the discharged battery first, then connect the other end of the positive cable to the (+) terminal of the donor battery.

On-board diagnostics

- ▶ Connect the negative cable to the (-) terminal on the charged battery and then the other end to an earthed metal part that is bolted to the engine block.



Note:

Keep as far as possible from the discharged battery.

- ▶ Run the engine of the donor vehicle at an elevated speed.
- ▶ Start the engine of the bus to be jump-started in the normal way and let it run at idling speed.
- ▶ Switch off the engine of the donor vehicle.

- ▶ Fully disconnect the earth connection of the jump leads then disconnect the positive cable.



Note:

To prevent voltage peaks, switch on the more powerful consumers of the jump-started bus, such as the lighting, heated windows or ventilation, before you disconnect the jump leads.

On-board diagnostics

Activating the on-board diagnostics



Note:

On-board diagnostics cannot be regarded as a substitute for off-board diagnostics (STAR Diagnosis) because off-board diagnostics is the only means by which some functions can be monitored and tested (e.g. the channel assignment for the sensor system and actuators of the EBS or ABS/ASR system).

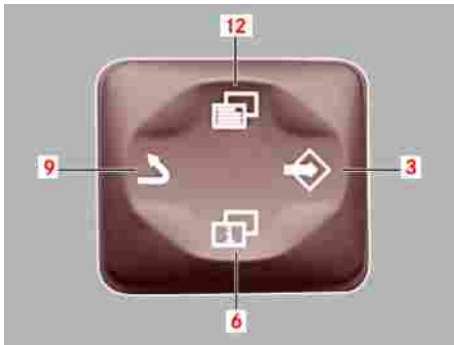

M54_30-0105-71

- ▶ Press button (12) of the control rocker switch repeatedly until the relevant system appears on the display screen.



Note:

The on-board diagnostics cannot be operated unless bus stationary, parking brake engaged, ignition starter switch position "ON"



Danger.

All work carried out on the bus in order to rectify displayed faults must be performed by authorised personnel only.

AGN - Automatic transmission (option)

BS - Brake control

FR - Drive control or CPC (common powertrain controller)

GS - Transmission control

INS - Driver's station instrument panel

MR - Engine control

NR - Level control

RS - Retarder control

TCO - Tachograph

ZL - Auxiliary steering

ZHE - Auxiliary heating



M54_30-0128-71

- ▶ The system concerned (1) and the Mercedes-Benz item number (control unit) (2) are displayed. To call up further information, press button (6) on the control rocker switch.



Note:

The following information can be displayed: MB part number, events, measured values, binary values, clear events.

On-board diagnostics

Interpreting the on-board diagnostics screen display

- ▶ Only current faults can be displayed.

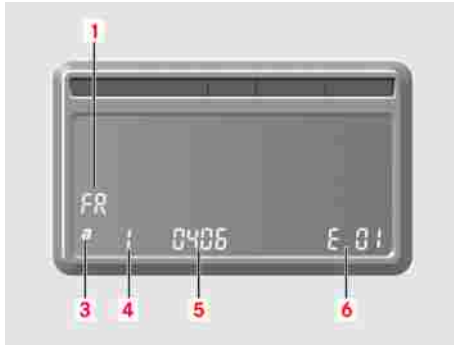

M54_30-0129-71

- ▶ Example:

- 1 - FR or CPC (common powertrain controller)
- 3 - current fault
- 4 - fault severity 1
- 5 - fault code 0406
- 6 - fault (counter) E 01

Clearing the fault memory of the selected system



M54.00-1917-71

- ▶ After the last display message, it is possible to clear the fault memory using reset button (1).

Ending on-board diagnostics

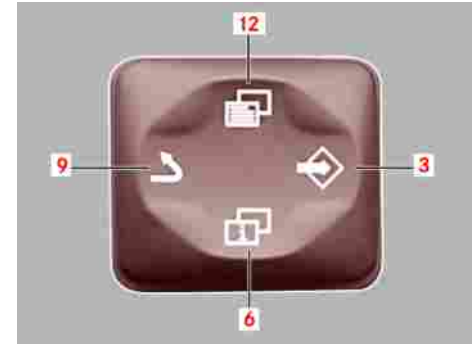

M54_30-0105-71

- ▶ Press button (9) to return to the basic display.

Chassis technical data **218**

Chassis technical data

Chassis technical data	
Designation	Value
Permissible gross vehicle weight (country-specific)	19,000 kg
Maximum permissible axle load for front axle (country-specific)	7,100 kg
Maximum permissible axle load for rear axle (country-specific)	12,000 kg
Track width, front axle	2,101 mm
Track width, driven axle	1,802 mm
Track width, trailing axle	2,055 mm
Tyre size	275/70 R 22.5

Designation	Value
Tyre size (option)	295/80 R 22.5
Tyre size (option)	11 R 22.5

- A**
- Acceleration skid control (ASR)** .. 45
 - Deactivation 138
 - AdBlue®**
 - Service product 26-27
 - Anti-lock braking system (ABS)** 43-44
 - Auxiliary heater fuel filter**
 - Replacing 199-200
 - Auxiliary heating**
 - Operation 149-151
 - Preset timer 148
 - Preset timer (overview) 78-79
 - Safety precautions 8
- B**
- Batteries**
 - Disconnecting 211
 - Recharging 212
 - Safety precautions 201
 - BlueTec® exhaust gas cleaning system** 24-25
 - Brake system**
 - Supply pressures 49
 - Brake system (BS)** 42
- Bus stop brake** 46
 - With drive-off lock 47-48
- C**
- Care and cleaning**
 - Safety precautions 55-57
 - Checking the coolant level of the engine and heating system** 170
 - Compressed-air system**
 - Charging 197
 - Continuous brakes**
 - Operating information 50-53
 - Cruise control** 157
 - Activating 158
- D**
- Departure check**
 - Daily tasks 10
 - Weekly tasks 11
 - Diesel particulate filter**
 - Important information 31-32
 - Regeneration 33, 138
 - Drive belts (OM 936)**
 - Fitting 173-176
 - Removing 171-172
 - Driving** 18
- Driving systems**
 - Overview 154
- E**
- Electric fuel pump** 168
 - Electrical system**
 - Measures required for the prevention of damage 202-203
 - Safety precautions 201
 - Electronic Stability Program (ESP)**
 - Deactivating 41
 - Deactivation 138
 - Engine**
 - Starting 15-16
 - Starting (using the pushbutton) .. 17
 - Stopping 19-20
- F**
- Flat tyre/wheel change**
 - Safety measures 187
 - Fuse assignment**
 - Driver's area switch panel .. 204-206
 - Main fuses on auxiliary switch panel 208-209
 - Fuses**
 - Handling 210

I	
Instrument cluster	60-63
Instrument cluster display screen	
Display screen symbols	121-127
Malfunction displays: Description	108
Malfunction displays: red warning level - description . .	109-110
Malfunction displays: STOP lamp - description	118
Malfunction displays: yellow warning level - description . .	113-114
Screen sequence at start-up . . .	104
Instrument display panel	97-103
Instrument lighting	
Adjusting	107
J	
Jump-starting	
Notes	212
Procedure	213
O	
On-board computer	66-69
Display screen	105-106
On-board computer display screen	
Malfunction displays with red status indicator - overview	112
Malfunction displays with red STOP warning lamp - overview . .	120
Malfunction displays with yellow status indicator - overview	116-117
On-board diagnostics	
Activation	214
Clearing the fault memory of the selected system	216
Ending	216
Interpreting the screen display . .	216
Operating/malfunction displays	
Driving systems	159-160
Fuel system	36
P	
Parking brake	91-92
Applying/releasing	39
Pneumatic test ports	
Under the driver's area	196

R		
Refuelling		
AdBlue®	28-30	
Diesel fuel	22-23	
Running-in guideline	15	
S		
Steering		
Important information	131	
Steering column		
Adjusting	90	
Steering-oil reservoir		
Checking the oil level	198	
T		
Tachograph		
DTCO	72-73	
MTCO	74-75	
Tools and emergency equipment .		76
Tow-starting		22
Tyre pressures table		
11 R 22.5	184-185	
275/70 R 22.5	182-183	
295/80 R 22.5	186	

Tyres

- Inflating using the tyre inflator connection 193-195
- Invisible tyre damage 179
- Operating safety and roadworthiness 177
- Retreaded tyres 180
- Tyre age 178
- Tyre condition 178
- Tyre load capacity, top speed of tyres and types of tyres 179
- Tyre pressure 177
- Tyre tread 178

V

- Variable speed limiter (Tempo-
poset)** 154
- Activating 155-156

W

- Warning and indicator lamps** . 64-65
- Wheel trims**
- Removing 189
- Wheels**
- Fitting 191-192
- Removing 191